

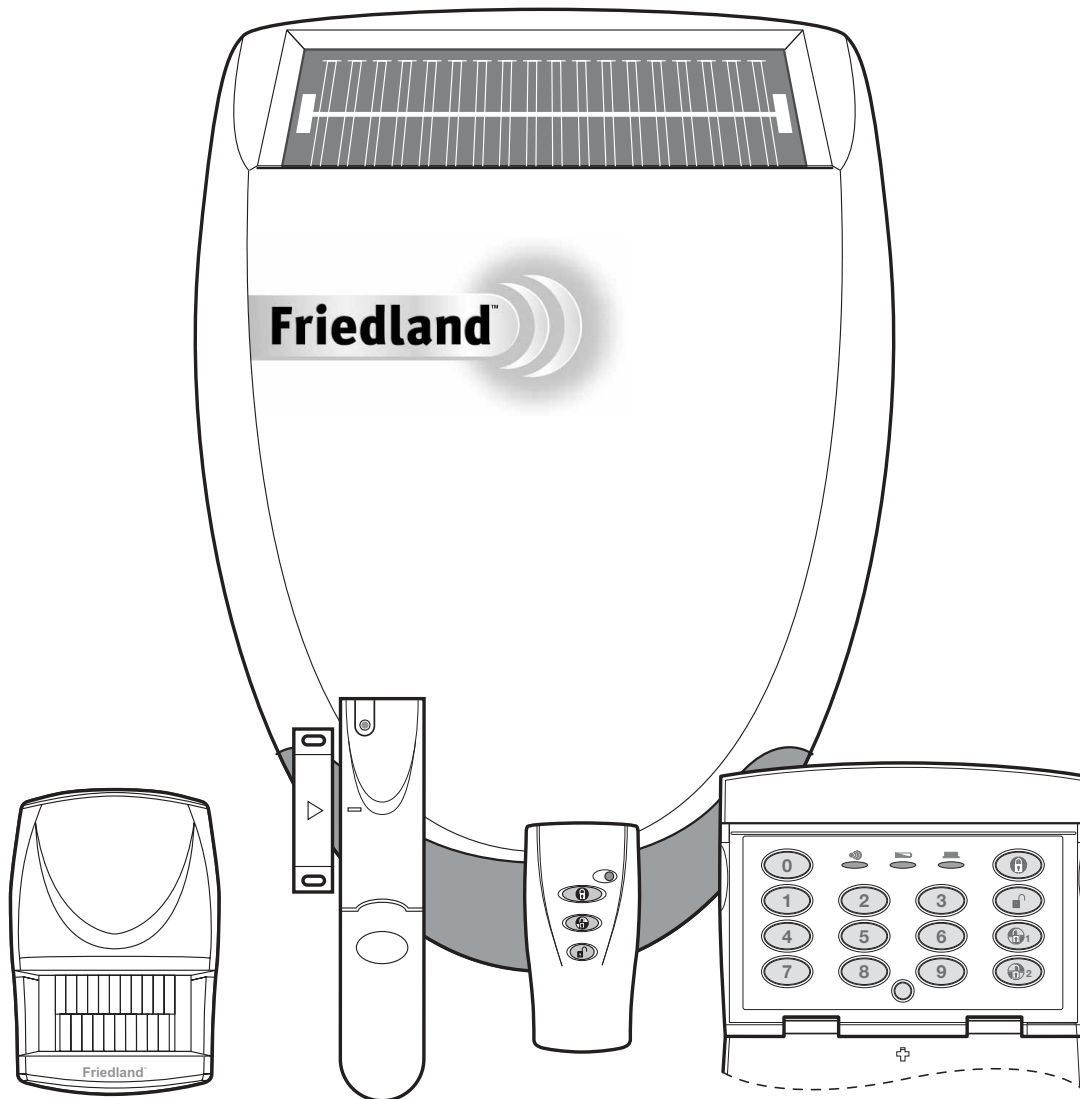

Wirefree Security Alarm

Bronze / Silver



Installation & Operating Manual

FOREWORD

All devices in this Wirefree Alarm System are designed and manufactured to provide long reliable service. The system is designed for ease of installation using only conventional domestic tools. However, it is essential that the installer reads and fully understands the advice and procedures contained in this manual and plans the system before proceeding with the installation.

During installation, it is important that the procedures described in this manual are followed in sequence.

This manual should be retained in a safe place for future reference.

IMPORTANT: All devices, with the exception of the External Siren are suitable for mounting in dry interior locations only.

IMPORTANT:

LOCAL AUTHORITY REGULATIONS AND LEGISLATION

This alarm system should be installed and operated in accordance with the requirements of any current local and/or national regulations and legislation. We recommend that you contact your authority to obtain details of your area's requirements regarding intruder alarm installations.

DECLARATION

Novar ED&S hereby declares that this wirefree alarm system is in compliance with the essential requirements and other relevant provisions of the Radio and Telecommunications Terminal Equipment (R&TTE) directive, 1999/5/EC.

Tools and Equipment Required:

No.0 Philips Screwdriver	Bradawl
No.1 Philips Screwdriver	Drill
No.2 Philips Screwdriver	3mm Drill Bit
Small Spirit Level	5 & 6mm Masonry Drill Bits

DEVICE RANGE

The quoted range of the system devices (see component specification on rear cover) is measured in ideal conditions. Any solid object (e.g. walls,

ceilings, reinforced PVC doors etc) placed between the transmitter and Receiver device will reduce the radio range.

The amount by which the range will be reduced is dependant upon the nature of the barrier.

For example:

Wall Type	Range Reduction
Dry-lined partition wall:	10 - 30%
Single layer brick wall:	20 - 40%
Double layer brick wall:	30 - 70%
Metal panel/radiator:	90 - 100%

Note: The effect on the range of multiple walls is cumulative, i.e. if there are 2 brick walls in the way, the range will be reduced by up to 40% by each wall.

SYSTEM SECURITY

This system has been designed to both detect intruders and act as a strong deterrent to would-be intruders when installed correctly.

We recommend that your Alarm is used in conjunction with good physical protection such as security window and door locks.

All units in the system are encoded to operate together using a 20 bit House Code.

The system is operated from one or more Remote Control Units and/or Keypads.

SAFETY

Always follow the manufacturers advice when using power tools; steps, ladders etc. and wear suitable protective equipment (e.g. safety goggles) when drilling holes etc.

Before drilling holes in walls, check for hidden electricity cables and water pipes, the use of a cable/pipe locator maybe advisable if in doubt.

When using ladders, ensure that they are positioned on a firm stable surface at the correct angle and suitably secured before use.

The use of ear defenders is advisable when working in close proximity to the Siren due to the high sound level produced by this device.

CONTENTS

KIT CONTENTS	4	MAGNETIC CONTACT DETECTORS	16
		Positioning the Magnetic Contact Detectors	16
INTRODUCTION AND OVERVIEW	5	Installing and Configuring the Magnetic Contact Detectors	16
System Arming	5	Testing the Magnetic Contact Detectors	18
Entry/Exit Delay	5		
Alarm Lockout	5	ADDING A NEW PIR OR MAGNETIC (MAG) DOOR/WINDOW CONTACT DETECTOR TO THE SIREN	18
Tamper Protection	5		
Jamming Detection	5	DELETING ALL DEVICES FROM THE SYSTEM	19
Battery Monitoring	5		
User Access Code	5	SIREN SERVICE/OPERATING MODE	19
PLANNING AND EXTENDING YOUR ALARM SYSTEM	6	TESTING THE SYSTEM	20
Typical Installation	6	OPERATING INSTRUCTIONS	21
		Arming the System in Instant-Arm Mode	21
REMOTE CONTROL UNIT	7	Arming the System in Delay-Arm Mode	21
General Information	7	Disarming the System	22
Configuring the Remote Control	7	Personal Attack (PA) Alarm	22
Testing the Remote Control	7	Device Tamper	22
		Siren Service Mode	22
KEYPAD	7	Siren Operating Mode	22
Positioning the Keypad	8	Battery Monitoring	22
Installing and Configuring the Keypad	8	MAINTENANCE	24
Changing the User Access Code	9	TROUBLE SHOOTING	25
Personal Attack/PA	9	EXTENDING YOUR ALARM SYSTEM	27
Resetting to Factory Defaults	9	COMPONENT SPECIFICATION	28
EXTERNAL SOLAR SIREN	10		
General Information	10		
Positioning the Solar Siren	10		
Installing and Configuring the Solar Siren	10		
Power-up of the Solar Siren	11		
Adding a new Remote Control or Keypad to the Solar Siren	12		
Mounting the Solar Siren on to the wall	13		
PASSIVE INFRA-RED (PIR) MOVEMENT DETECTORS	13		
Positioning the PIR Detectors	13		
Installing and Configuring the PIR Detectors	14		
Testing the PIR Detectors	15		

KIT CONTENTS

The Alarm System should contain the following devices.

Alarm System	SK1 Bronze	SK2 Silver
Solar Siren	1	1
Remote Control	1	1
PIR Movement Detectors	2	2
Magnetic Contact Detectors	0	2
Keypad	0	1

Also included:

- Siren Mounting Template
- Installation & Operating Manual
- Installation DVD
- Fixing Pack
- Batteries

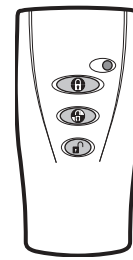

Remote Control

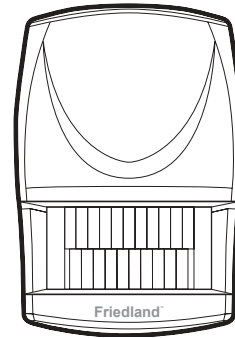

PIR Movement Detector

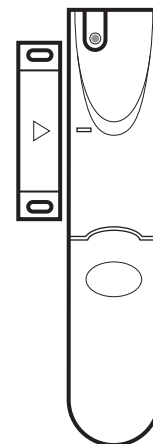

Magnetic Contact Detector

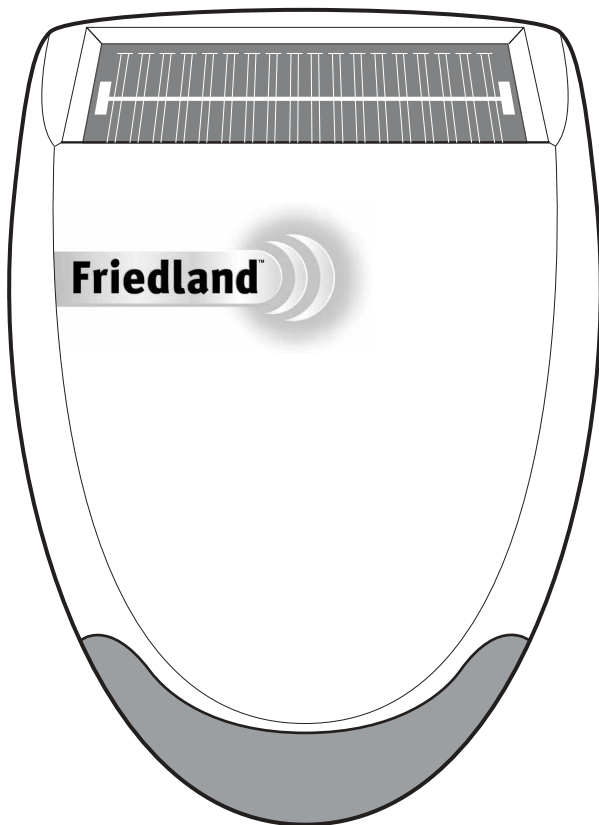

Solar Siren

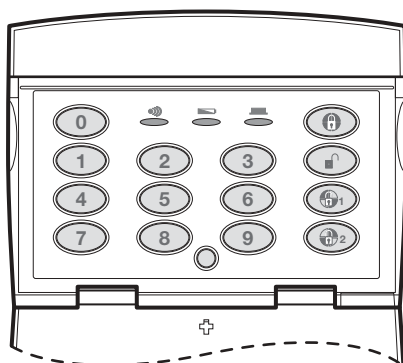

Keypad

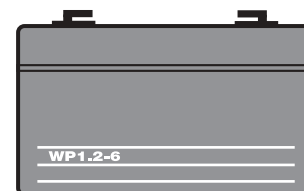

6V/1.2Ah Sealed lead acid battery
(supplied fitted in Siren)



9V PP3 Alkaline battery
(for Siren, Keypad and
PIR Detectors)



3V CR2032 Lithium Coin Cell
(for Remote Control and
Magnetic Contact Detectors)

INTRODUCTION AND OVERVIEW

SYSTEM ARMING

The system has an Instant-Arm and Delay-Arm mode.

If the system is armed in Instant-Arm mode then all detectors will immediately become fully armed. Any detector triggered while the system is armed will immediately sound an alarm.

ENTRY/EXIT DELAY

If the system is armed in Delay-Arm mode this will activate the system with a fixed 15 second entry/exit delay period. This allows a 15 second period for the user to exit the property after setting the system with the Remote Control or at the Keypad. Any detector triggered while the system is armed will not cause an alarm condition until after the 15 second entry delay has expired. This allows time for the system to be Disarmed before an alarm sounds when re-entering the property.

Note: To conserve power and maximise battery life the PIR Detector will only detect movement if there has been no movement detected within the previous 2 minutes. Consequently the PIR Detector will not become active until the protected area has been free from movement for more than 2 minutes.

ALARM LOCKOUT

If a detector is triggered while the system is armed, the alarm will sound. After the set alarm duration has ended, the alarm will stop and the system will automatically reset. Subsequent detectors triggered will again sound the alarm. If the alarm is triggered more than 3 times then it will become 'Locked Out' and any further alarm signals will be ignored until the system is re-armed.

TAMPER PROTECTION

All system devices (except the Remote Control) incorporate Tamper protection features to protect against unauthorised attempts to interfere with the device.

Any attempt to remove the battery cover from any device (except a Remote Control) or to remove the Siren from the wall will trigger an alarm (unless the system is in Service Mode), even if the system is Disarmed.

JAMMING DETECTION

In order to detect any attempts to illegally jam the radio channel used by your alarm system, a special jamming detection function is incorporated into the Siren. If this feature is enabled, an alarm will be triggered if the radio channel is jammed continuously for more than 30 seconds or if the system is jammed for more than 3 periods of 10 seconds in a 5 minute period. (The Siren will emit a series of rapid beeps as a pre-alarm warning 10 seconds before a full alarm occurs).

The jamming detection circuit will constantly scan for jamming signals. However, it will also detect and could in extreme cases be triggered by radio signals from other radio equipment within range operating on the same frequency which would not interfere with the normal operation of your alarm.

If you are planning to operate the Jamming Detection feature we recommend that you wait at least 30 days before activating this feature to allow time for you to become familiar with the operation of your system.

When activating jamming detection the system should be monitored carefully for false jamming alarms for at least 2 weeks before leaving the Jamming Detection function permanently enabled.

BATTERY MONITORING

All devices powered by non-rechargeable batteries incorporate a battery level monitoring feature which will warn of a low battery status. The batteries on any device indicating a low battery status should be replaced immediately.

USER ACCESS CODE

The Siren is the heart of the system where it can be accessed for operating or programming via a Remote Keypad. A 4 digit code is used to ensure that only authorised people have access to the system. This is the User access code and can be set to a code of your choice that only you and other authorised system users know.

PLANNING AND EXTENDING YOUR ALARM SYSTEM

Before attempting to install your alarm system it is important to study your security requirements and plan your installation.

PIR Movement Detectors are used to protect the main areas of the property, (e.g. lounge, study, hallway and landing). Magnetic Contact Detectors are typically used to protect the main access points to the property, (e.g. front door, back door, patio doors). However, they can also be used to protect other vulnerable doors/windows or access doors to important rooms.

TYPICAL INSTALLATION

The following example below shows a typical property incorporating the suggested positions for

the Siren, Keypad, PIR and Magnetic Contact Detectors for optimum security. Use this as a guide for your installation in conjunction with the detailed positioning requirements for each device provided in the appropriate installation sections in this manual for planning your intruder alarm system.

The alarm system may be extended to provide greater protection and control by fitting additional PIR Movement Detectors, Magnetic Contact Detectors, Remote Controls and Keypads as required. Any number of accessories may be used with your system, provided that they are all within radio range of the Siren.

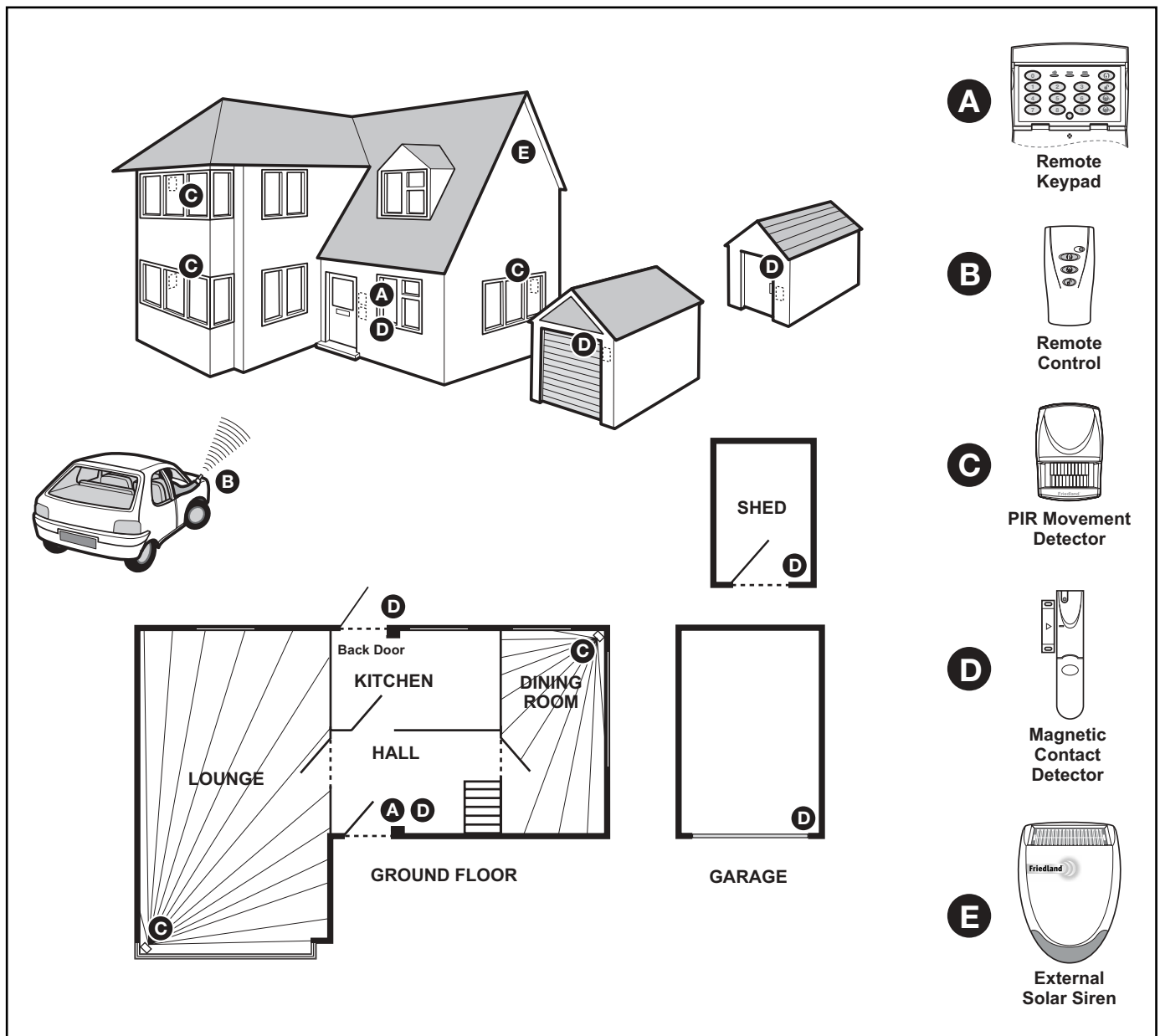

REMOTE CONTROL UNIT

The Remote Control Unit(s) is used to Arm in either Instant-Arm or Delay-Arm modes and to Disarm the system.

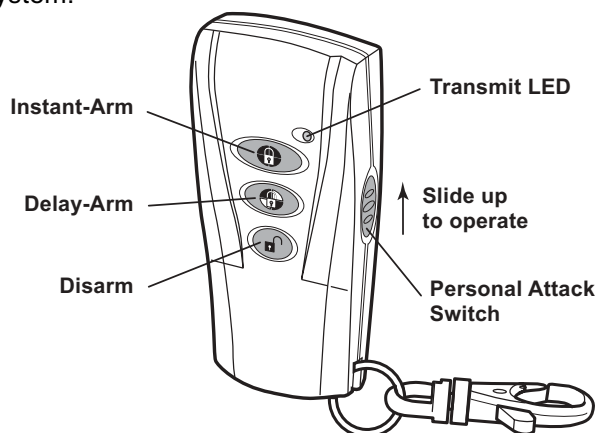

The Remote Control Unit also incorporates a Personal Attack (PA) switch. Activating the PA switch on the side of the Remote Control will immediately trigger an Alarm even if the system is disarmed (unless the Siren is in Service Mode). The alarm can be cancelled by pressing the 'DISARM' button on the Remote Control.

Up to a total of 6 Remote Controls and/or Keypad Units can be used with your system, providing they are all operated within effective radio range of the Siren.

The Remote Control is powered by a CR2032 type Lithium cell which under normal conditions will have an expected life of approximately 1 year. Under normal battery conditions the Transmit LED on the Remote Control will only illuminate when a button is pressed.

However, under low-battery conditions this LED will continue to flash after the button has been released. When this occurs the battery should be replaced as soon as possible.

CONFIGURING THE REMOTE CONTROL

1. Remove the rear cover by undoing the small screw on the rear of the Remote Control and keeping it safe for later.
2. Insert the battery under the clip ensuring that the + terminal faces upwards away from the Circuit Board.
3. Replace the rear cover and fixing screw. Do not over tighten the screw as this could damage the thread.

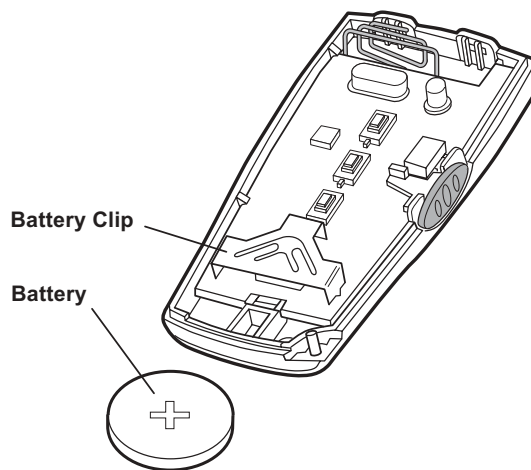

TESTING THE REMOTE CONTROL

4. Press the  button. The Transmit LED should illuminate while the button is pressed and extinguish within 1 second of releasing the button.
5. Pressing any button on the Remote Control will illuminate the Transmit LED as before to check that it is functioning correctly.
6. In order to communicate with the Siren, the ID code of the Remote Control needs to be learned by the Siren, subject to the Siren Unit being installed and configured if it is being set-up for the first time (see pages 10 - 12).

KEYPAD

The Keypad is used to control the Siren and to Arm and Disarm the system by entering a 4 digit User Access Code. The Keypad can arm the system in either Instant or Delay modes.

The Keypad incorporates a tamper protection facility. Any attempt to open the casing of the Keypad will immediately trigger an alarm even if the system is disarmed, (unless the system is in Service Mode). In addition if a sequence of more than 16 incorrect key presses is entered the Keypad will be disabled for the next 1 minute, (except for the tamper protection function). If the Keypad is disabled three times consecutively a 'Tamper signal' will be triggered.

Up to a total of 6 Keypad Units and/or Remote Controls can be used with your system, providing they are all operated within effective radio range of the Siren.

The Keypad also incorporates a Personal Attack (PA) facility which will immediately trigger an alarm when activated, (unless the Siren is in Service Mode).

The Keypad is powered by a PP3 Alkaline battery which under normal conditions will have an expected life of approximately 1 year. When the battery level drops, the "LOW BATT" LED on the front of the Keypad will flash. When this occurs the battery should be replaced as soon as possible.

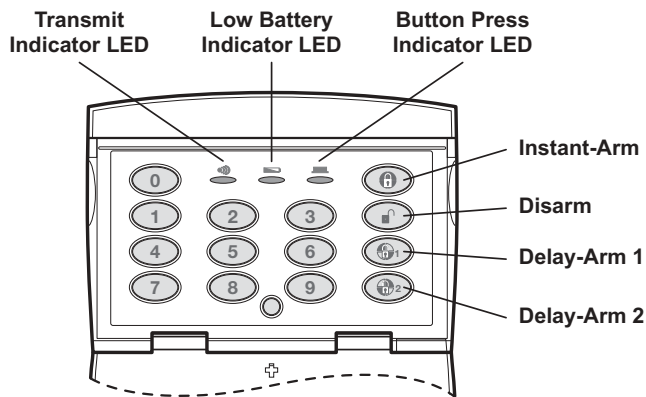

When using the Keypad the buttons must be pressed firmly and within five seconds of each other. If you make a mistake, wait ten seconds and start again.

When a button is pressed the  LED will illuminate.

The Keypad has a back light which illuminates the buttons for 5 seconds when the cover is first opened or for 5 seconds after any key is pressed.

POSITIONING THE KEYPAD

The Keypad is suitable for mounting in dry interior locations only.

The Keypad should be located within a protected area so that it cannot be reached by an intruder without opening a protected door or passing through an area protected by a PIR Movement Detector.

The Keypad should be mounted in a position close to the main entrance door so that the User Access Code can be entered and the alarm system shut down within the 15 seconds entry time period.

Note: DO NOT fix the Keypad onto or very close to metalwork (e.g. radiators, water pipes, etc) as this could affect the radio range of the device.

INSTALLING AND CONFIGURING THE KEYPAD

Note: If adding a Keypad to an installed system, ensure that the Siren is in Service Mode before commencing installation, (see page 19). Remember to switch the Siren back to Operating Mode after

installation is complete, (see page 19). If the Siren Unit is being installed and configured for the first time refer to pages 10 - 12.

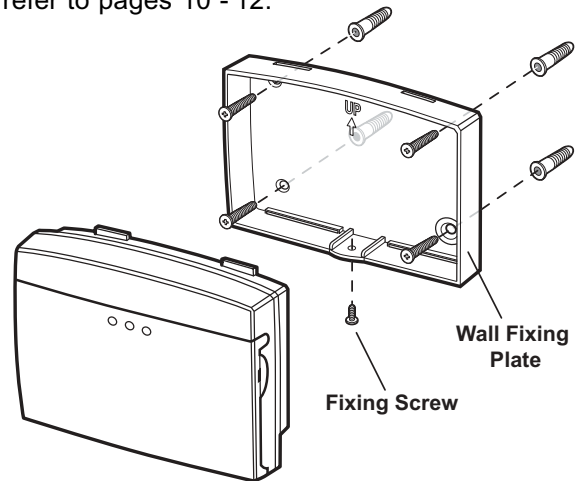

1. Undo and remove the fixing screw from the bottom edge of the Keypad and remove the wall mounting plate.
2. Using the mounting plate as a template, mark the positions of the four fixing holes on the wall. A small spirit level will ensure it is perfectly level.
3. Fix the mounting plate to the wall using the four 18mm No.4 screws and 22mm wall plugs as required, (a 5mm hole will be required for the wall plugs). Do not over-tighten the screws as this may distort or damage the mounting plate.

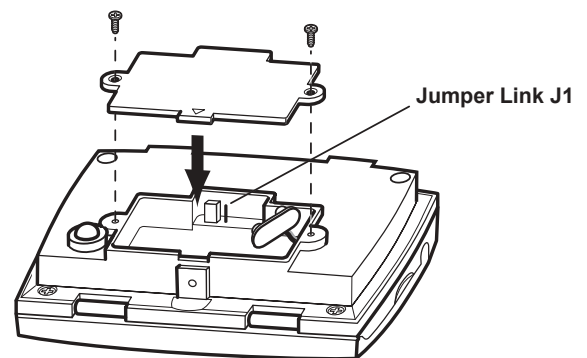

4. Undo and remove the two fixing screws securing the rear battery cover and remove the cover.
5. If the battery has already been installed then remove it.
6. Press and hold any key for more than 1 second.
7. Set the jumper link J1 as shown in Fig. 1b:



Fig. 1a

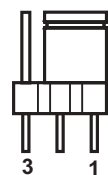
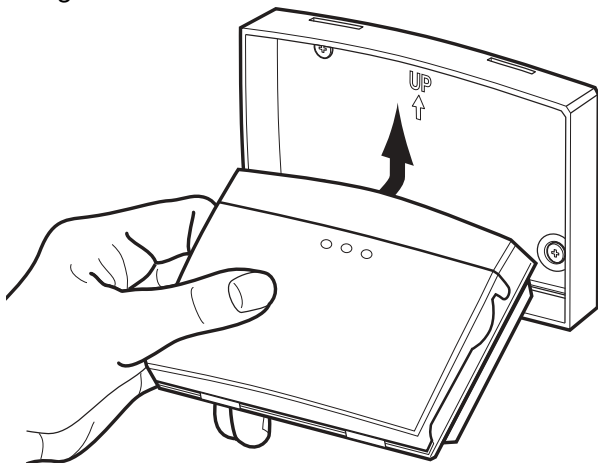

Fig. 1b

8. Connect the PP3 alkaline battery to the battery clip and set the jumper link J1 shown in Fig. 1a which is what the keypad is set to normally.
9. Replace the rear cover and refit fixing screws. Do not over-tighten the fixing screws.
10. Refit and secure the Keypad onto the wall mounting plate. Do not over-tighten the fixing screw.



11. In order to communicate with the Siren, the ID code of the Keypad needs to be learned by the Siren after the Siren has been setup if the installation is new (see page 12).







CHANGING THE USER ACCESS CODE

The Keypad is supplied with a User Access Code of: "1234". For security reasons, this code should be changed to another 4 digit number which only you and other users of the system should know.

IMPORTANT: When using the Keypad the keys must be pressed firmly and within 5 seconds of each other.



If you make a mistake, wait 10 seconds and recommence programming from the beginning of the sequence.

To change the User Access Code, press the following keys in sequence:

1. Press 
2. Enter the factory set (or current) User Access Code:
Code:    
Factory Default User Access Code
3. Press  the  LED will flash 3 times.

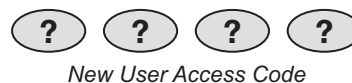

4. Enter a new User Access Code of your choice:



5. Press  the  LED will flash 4 times to confirm the setting has been accepted. If the LED does not flash, wait 10 seconds and try steps 1 - 5 again.







PERSONAL ATTACK/PA

Default setting: ON

Press and hold both  and  together for more than 2 seconds. The  LED will flash rapidly if both buttons are pressed at the same time.

The Personal Attack/PA feature can be disabled if required as follows.

To Enable the Personal Attack/PA Feature:



1. Press  ,  ,  ,  ,  , 
Current User Access Code

The  LED will flash three times.

2. Press  , 

The  LED will flash four times to confirm the setting has been accepted.

To Disable the Personal Attack/PA Feature:

1. Press  ,  ,  ,  ,  , 
Current User Access Code

The  LED will flash three times.

2. Press  , 

The  LED will flash four times to confirm the setting has been accepted.

RESETTING TO FACTORY DEFAULTS

If unfortunately, you forget the Administrator/User Access Code, you can set it back to factory default as follows:

1. Remove the battery.
2. Press and hold any key for more than 1 second.

3. Set the jumper link as shown in Fig. 1b. (below).
4. Refit the battery and test it by entering the Administrator Access Code 1234.
5. If testing is ok, set the jumper link as shown in Fig. 1a, which is what the keypad is set to normally.

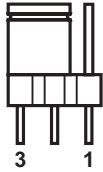

Fig. 1a



Fig. 1b

EXTERNAL SOLAR SIREN

The Siren is encapsulated within a tough polycarbonate housing that also provides full protection against adverse weather conditions.

An LED indicator unit is built into the Siren to act as a visible deterrent and indication that the system is active. The LEDs will slowly and alternately flash whether the system is Armed or Disarmed. When an alarm occurs the LEDs will flash rapidly together.

An integral tamper switch provides additional security protection to the Siren and will immediately trigger an alarm should any unauthorised attempt be made to interfere with and remove the Siren cover.

The Siren is powered by a rechargeable sealed lead acid battery. A solar panel mounted on the top of the housing charges the battery during daylight hours. During darkness, only a small amount of energy is required to operate the Siren unit. A 9V Alkaline PP3 battery is supplied to boost the initial power to the unit when the system is first activated until the solar panel charges the main battery. (This battery is only designed to last for a short period until the main rechargeable battery has obtained sufficient charge). It does not need to be replaced.

The Siren unit incorporates the installation's Jamming Detection system which will (if activated) generate an alarm if any attempt is made to continuously jam the radio channel used for the system.

POSITIONING THE SOLAR SIREN

The Siren should be located as high as possible in a prominent position on an external wall so that it can be easily seen and heard. The Siren should be mounted on a sound flat surface so that the rear tamper switch is not activated when mounted.

Ensure that the tamper switch does not fall into the recess between brick courses as this could prevent the switch from closing and give a permanent tamper signal.

In order to provide the maximum amount of daylight to the solar panel, the Siren should ideally be mounted on a south facing wall. However, an easterly or westerly position will suffice, but mounting the device on a north facing wall should be avoided due to the short dark days of winter months.

Shadows cast by neighbouring walls, trees and roof overhangs should also be avoided. If the Siren is to be mounted below the eaves, it should be positioned a distance of at least twice the depth of the eaves overhang below the eaves. Remember that in winter the sun is lower in the sky and you should avoid winter shadows where possible.

The Solar Siren contains a sophisticated radio receiver. However, reception of radio signals can be affected by the presence of metallic objects within the vicinity of the Siren. It is therefore important to mount the Siren a minimum distance of 1 metre away from any external or internal metalwork, (i.e. drainpipes, gutters, radiators, mirrors etc). Be especially aware of radiators mounted on the inside wall behind possible locations for the Siren.

Ensure that the position selected for the Siren is within effective range of the Keypad and all detectors.

INSTALLING AND CONFIGURING THE SOLAR SIREN

1. Working on a table, undo the two battery cover fixing screws and remove the battery cover.
2. Under the cover you will also find a row of 5 DIP Switches labelled SW3 and a "LEARN" button.

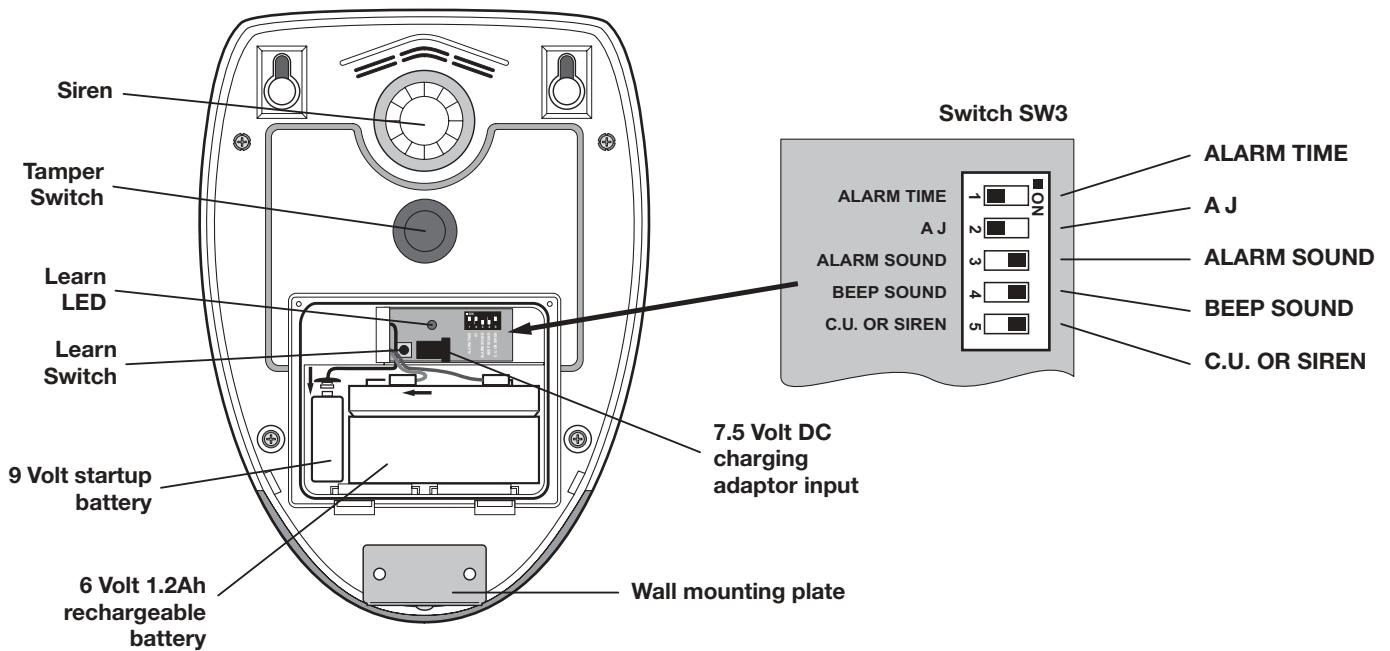

3. Ensure that DIP switch 5 of SW3 on the main board is set to **ON** ("C.U.") for use with this alarm system.

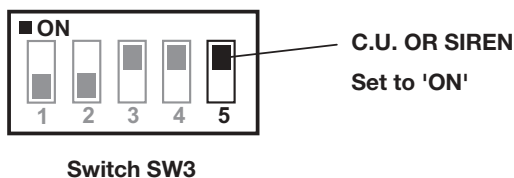

4. DIP switch 1 marked "**ALARM TIME**" is used to limit the maximum period for which the external siren will sound before it will be automatically shut down:

ON	3 minutes
OFF	1 minutes
5. DIP switch 2 marked "**AJ**" controls the anti-jamming detection facility in the siren:

ON	Jamming Detection enabled
OFF	Jamming Detection disabled
6. DIP switch 3 marked "**ALARM SOUND**" if OFF will prevent the siren from sounding during an alarm, (this will not affect the warning beeps):

ON	Siren enabled
OFF	Siren disabled
7. The Solar Siren will acknowledge signals from the Remote Control or Keypad by beeping and flashing the LEDs. It is possible to disable these acknowledgement beeps DIP switch 4 marked "**BEEP SOUND**".

ON	Beeps enabled
OFF	Beeps disabled
8. Now see Power-Up of the Solar Siren.

POWER-UP OF THE SOLAR SIREN

Note: The use of ear defenders is advisable when working in close proximity to the Siren due to the high sound level produced by this device when triggered. When the system is first installed, it will automatically power up in Service Mode. It cannot be switched out of Service Mode and into Operating Mode until at least one Remote Control or Keypad is link to it.

9. Connect the rechargeable battery to the battery leads. Connect the Red lead to the Red (+ve) terminal and the Black lead to the Black (-ve) terminal.
Connect the 9V 6LR61 (PP3) power-up battery to the battery clip.
10. Press the tamper switch, both indicator LEDs will flash together several times. The LEDs will then continue to flash alternately every 5 seconds thereafter to indicate that the Siren is functioning.
11. If fitted remove the protective film covering the Solar Panel.

IMPORTANT: Once the batteries have been connected, the Siren will be operational and it is important that the solar panel receives sufficient light to maintain the battery charge. The Siren should not be operated repeatedly during installation and testing, as this will rapidly drain the battery. It is recommended that the Siren be left for at least a day in order to charge the battery before the system is Armed.

ADDING A NEW REMOTE CONTROL OR KEYPAD TO THE SOLAR SIREN

IMPORTANT: In order to communicate with the Siren, the ID code of the Remote Control/Keypad needs to be learned by the Siren. Whenever the Siren is being set-up it will automatically enter **Service Mode** when it is powered-up, ready to learn a new Remote Control/Keypad. Alternatively if the Siren is already in **Operating Mode**, see page 19 to place the Siren into **Service Mode** before adding a new Remote Control/Keypad.

11. Put the siren into Learn Mode by pressing the “Learn” button for 5 seconds until the Siren emits a single short beep and the both the indicator LEDs and Learn LED will flash together slowly once every 2 seconds.

12. To program the Remote Control’s ID code into the Siren:

a) Press the  button on the new remote control.

If the Remote Control is new and not already linked the siren will produce two short low volume beeps and the Indicator/Learn LEDs will start flashing together rapidly, (once every second).

Note: If the Remote Control is already linked to the siren or if there are already the maximum 6 Remote Controls/Keypads linked to the siren then the siren will produce a single long low volume beep and exit Learn Mode. The Learn / Indicator LEDs will stop flashing.

b) Confirm the new device ID code by pressing the  button on the same new Remote Control within 15 seconds.

The siren will produce three short low volume beeps and the Indicator/Learn LEDs will stop flashing and remain ON for 3 seconds after which it will go out.

Note: If the confirmation signal is not received within 15s the Indicator/Learn LEDs will stop flashing and turn off and the siren will produce a single long low volume beep and exit Learn Mode.

13. To program the Remote Keypad’s ID code into the Siren repeat step 11:

a) Press  , 
New Keypad User Access Code

on the new Keypad.

If the Remote Keypad is new and not already linked the siren will produce two short low volume beeps and the Indicator/Learn LEDs will start flashing together rapidly, (once every second).

Note: If the Remote Keypad is already linked to the siren or if there are already the maximum 6 Remote Controls/Keypads linked to the siren then the siren will produce a single long low volume beep and exit Learn Mode. The Learn / Indicator LEDs will stop flashing.

b) Confirm the device ID code by pressing

 , 
New Keypad User Access Code

on the Keypad within 15 seconds.

The siren will produce three short low volume beeps and the Indicator/Learn LEDs will stop flashing and remain ON for 3 seconds after which it will go out.

Note: If the confirmation signal is not received within 15s the Indicator /Learn LEDs will stop flashing and turn off and the siren will produce a single long low volume beep and exit Learn Mode.

The new Remote Control is now linked to the Siren and its ID code recorded into the Sirens memory.

The siren will now return to Service Mode.

14. Refit the battery cover and tighten the screws. Do not over tighten the screws as this may damage the thread.

15. If this is a new installation, mount the Siren onto the wall as follows:

MOUNTING THE SOLAR SIREN ON TO THE WALL

16. Hold the clear plastic mounting template supplied in position and mark the positions of the four mounting holes. A spirit level placed on the top edge will help ensure you get the unit level.
17. Undo the fixing screw securing the mounting plate from the bottom edge of the siren and remove the plate.
18. Drill four 6mm holes and fit the wall plugs.
19. Fit the two 30mm fixing screws in the top holes leaving approximately 9mm of the screw protruding.
20. Fit the keyhole slots in the top of the siren over these screws and check that they form a neat fit with minimal movement. If necessary remove the siren and adjust the screws as required.
21. Remove the siren and fit the wall mounting plate in position using the two 25mm fixing screws.
22. Fit the siren to the wall ensuring that the keyhole slots are correctly fitted over the heads of the two top fixing screws and the lower fixing hole lines up with the wall plate.
23. Secure the Siren in place by fitting the lower fixing screw in the wall plate. Do not over-tighten the screw as this could damage the thread.

IMPORTANT: Ensure that the rear tamper switch is closed when you fit the siren to the wall (i.e. listen for the switch to click). If the switch does not close it will prevent the Siren from operating correctly. If necessary, remove the siren again and insert a spacer between the tamper switch plunger and the wall to ensure the switch closes when the Siren is secured in position.

24. To add a PIR or Magnetic Door Contact Detector(s) to the system, allow the Siren to remain in Service Mode before switching to Operating Mode.

IMPORTANT:
The Siren must now be left in position for at least 24 hours to fully charge the Main Battery before testing or operating the alarm.

PASSIVE INFRA-RED (PIR) MOVEMENT DETECTORS

PIR Detectors detect movement in a protected area by detecting changes in infra-red radiation levels caused for example when a person moves within or across the PIR's detection pattern. If movement is detected an alarm will be triggered, (if the system is armed). PIR Detectors will also detect animals, so ensure that pets are not permitted access to areas fitted with PIR Detectors when the system is armed.

The Detector incorporates an anti-tamper protection feature to protect against attempts to interfere with the device. If the battery cover is removed, an alarm will immediately occur at any time, (unless the system is in Service Mode).

The PIR Detector also incorporates a sensitivity adjustment feature to compensate for situations where the detector may be triggered by environmental changes, (e.g. air temperature, etc).

To conserve power and maximise battery life the PIR Detector will only detect movement if there has been no movement detected within the previous 2 minutes, (this is known as the detectors sleep period).

The PIR Detector is powered by a 9V PP3 Alkaline battery which under normal conditions will have an expected life of approximately 1 year. When the battery level drops, with the PIR in normal operation mode and the battery cover fitted, the LED behind the detection window will flash. When this occurs the battery should be replaced as soon as possible. (**Note:** in normal operation, the LED behind the lens will not flash on detection of movement).

Up to a total of 12 detectors (PIR Movement Detectors and/or Magnetic Contact Detectors) can be used with the system, providing they are all mounted within effective radio range of the Siren.

POSITIONING THE PIR DETECTORS

The recommended position for a PIR Detector is in the corner of a room mounted at a height between 2 and 2.5 metres. At this height, the detector will have a maximum range of up to 12 metres with a field of view of 110°.

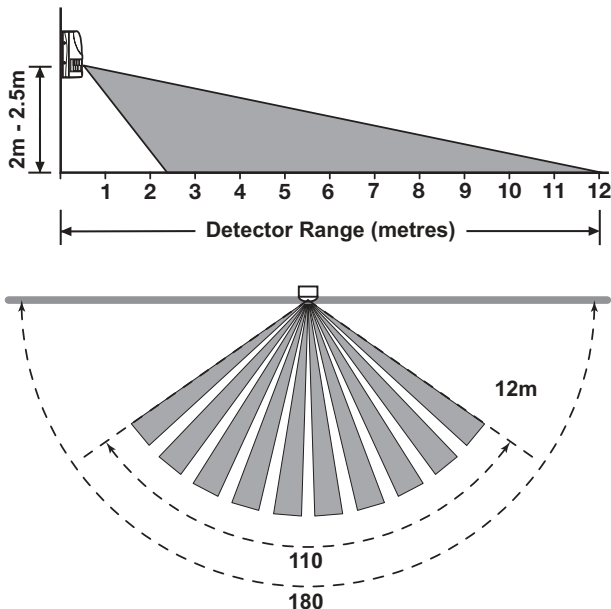

When deciding upon the mounting position for the detector the following points should be considered to ensure trouble free operation:

1. Do not position the Detector facing a window or where it is exposed to or facing direct sunlight. PIR Detectors are not suitable for use in conservatories.
2. Do not position the Detector where it is exposed to draughts.
3. **Do not position the Detector directly above a heat source, (e.g. fire, radiator, boiler, etc).**
4. Where possible, mount the Detector in the corner of the room so that the logical path of an intruder would cut across the fan detection pattern. PIR Detectors respond more effectively to movement across the device than to movement directly towards it.
5. Do not position the Detector in a position where it is subject to excessive vibration.
6. Ensure that the position selected for the PIR Detector is within effective range of the Siren.
7. **Do not fix the PIR Detector onto or very close to metalwork (i.e. radiators, water pipes, etc) as this could affect the radio range of the device.**

Note: When the system is Armed, pets should not be allowed into an area protected by a PIR Detector as their movement could be detected and trigger an alarm.

INSTALLING AND CONFIGURING THE PIR DETECTORS

Note: If adding a PIR Detector to an installed system, ensure that the Siren is in Service Mode before commencing installation, (see page 19). Remember to switch the Siren back to Operating Mode after installation is complete, (see page 19).

1. Undo and remove the fixing screw from the bottom edge of the PIR Detector, (keep the screw safe for later). Carefully pull the bottom edge of the detector away from the rear cover and then slide down to release the top clips.
2. Carefully drill out the required mounting holes in the rear cover using a 3mm drill according to whether the unit is being mounted in a corner or against a flat wall.
3. Using the rear cover as a template, mark the positions of the fixing holes on the wall.

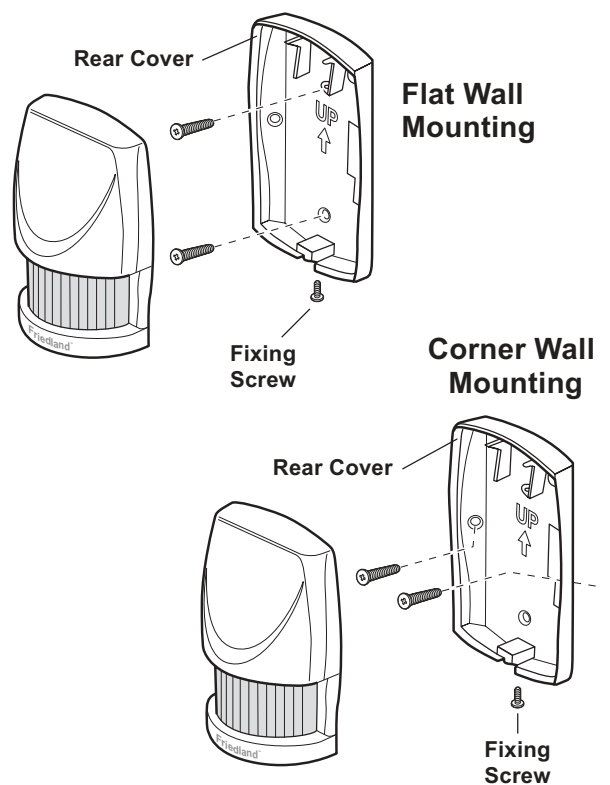

4. Fix the rear cover to the wall using the two 18mm No.4 screws and 22mm wall plugs, (a 5mm hole will be required for the wall plugs). Do not over-tighten the screws as this may distort or damage the cover.

Note: The wall plugs supplied with the product are not suitable for plasterboard walls, if mounting the Detector onto plasterboard use appropriate wall plugs.

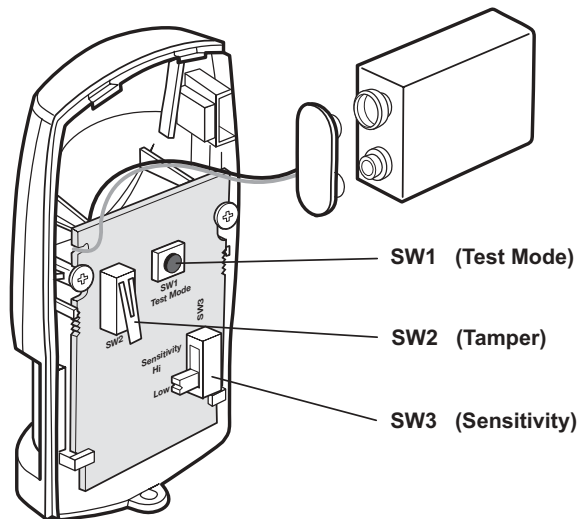

5. To select the required sensitivity, set switch SW3 as follows:

UP HIGH sensitivity
 DOWN LOW sensitivity

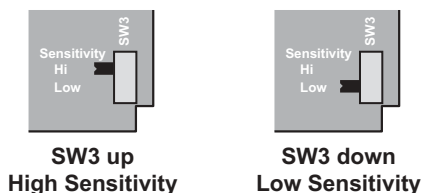

Note: The recommended setting is HIGH. However, in cases of extreme environmental problems or if unexplained false alarms are experienced, it may be necessary to set the sensitivity to LOW. Setting the device to LOW sensitivity will require a greater amount of movement in order to trigger the device.

6. Connect the PP3 Alkaline battery to the battery clip. The LED behind the lens will rapidly flash for approximately 2-3 minutes until the PIR has stabilised. The LED will then stop flashing and turn OFF.

TESTING THE PIR DETECTORS

7. Ensure that the LED indicator has stopped flashing rapidly.
8. The 'Test Mode' button (SW1) is used to put the PIR Detector into Walk Test mode, which overrides the 2 minute sleep period and allows the operation of the detector to be checked during installation. Press and hold the button for 2 seconds to activate Test Mode for a fixed 5 minute after which it will automatically revert

to normal operation. On initial installation the detector should be configured into Walk Test ready for testing, (i.e. Pressing down SW1 for 2 seconds).

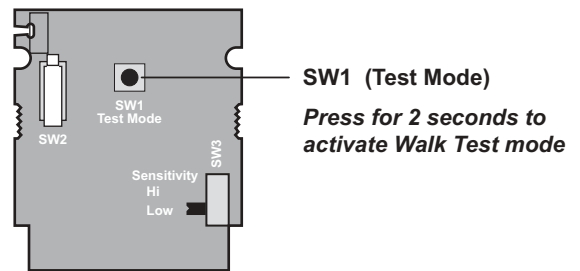

9. Refit the PIR Detector to the rear cover by offering the detector up to the rear cover and locate the clips in the top edge into the rear cover. Push the lower edge of the detector into place and refit the fixing screw in the bottom edge of the PIR to secure in position. Do not over-tighten the screws as this may damage the casing.
10. Walk into and move slowly around the protected area within the 5 minutes of pressing SW1. Each time the detector senses movement the LED indicator behind the lens will flash.

IMPORTANT: In normal operation, the LED indicator behind the detector lens will not flash on movement detection, (unless the battery is low).

Note: When the detector is fully installed, i.e. battery cover fitted and in operating mode; in order to conserve power and maximise battery life the PIR Detector will only detect movement if there has been no movement detected within the previous 2 minutes.

11. To allow the Siren to learn the PIR Detector's ID code, remove the Detector from its cover again and see Adding a new PIR/Magnetic Door/Window Contact Detector to the Siren on page 18.
12. Now refit the the Detector to the cover on the wall.
13. Switch the Siren into Operating Mode (see page 19).

MAGNETIC CONTACT DETECTORS

The Magnetic Contact Set comprises of two parts; a Detector and a Magnet. They are designed to be fitted to either doors or windows with the Magnet mounted on the opening part of the door/window and the Detector mounted to the frame.

When the protected door or window is opened and the Magnet is moved away from the Detector an alarm will be triggered if the system is armed, (unless the Siren is in Service Mode).

The Magnetic Contact Detector has the facility to connect an additional wired Magnetic Contact. This must be of a normally closed contact type with the contact being opened in order to generate an alarm condition.

The Magnetic Contact Detector is powered by two CR2032 type Lithium cells which under normal conditions will have an expected life of approximately 1 year. Under normal battery conditions the LED on the Detector will not illuminate when the Detector is triggered, (unless the detector is in Test Mode with the battery cover removed). However, under low battery conditions this LED will be illuminated for approximately 1 second when the detector is triggered. When this occurs the batteries should be replaced as soon as possible.

Up to a total of 12 detectors (Magnetic Contact Detectors and/or PIR Movement Detectors) can be used with the system, providing they are all mounted within effective radio range of the Siren.

POSITIONING THE MAGNETIC CONTACT DETECTORS

The Magnetic Contact Detector is suitable for mounting in dry interior locations only.

Decide which doors and windows are to be protected by fitting Magnetic Contact Detectors, (usually the front and back doors as a minimum will have Magnetic Contact Detectors fitted). However additional detectors may be fitted where required to other more vulnerable doors or windows, (e.g. garage, patio/conservatory doors etc).

Ensure that the position selected for the Magnetic Contact Detector is within effective range of the Siren.

Do not fix the Detector onto or very close to metalwork (i.e. radiators, water pipes, etc) as this could affect the radio range of the device.

On PVC door/window frames, it may be necessary to space the Detector and Magnet away from the metal surface using a plastic or wooden spacer to achieve the necessary radio range.

INSTALLING AND CONFIGURING THE MAGNETIC CONTACT DETECTORS

Note: If adding a Magnetic Contact Detector to an installed system, ensure that the Siren is in Service Mode before commencing installation, (see page 19). Remember to switch the Siren back to Operating Mode after installation is complete, (see page 19).

1. Remove the battery cover by sliding and lifting it off. (DO NOT use a screwdriver to lever it off).

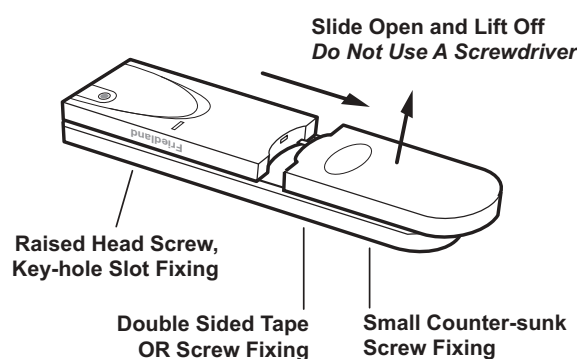

2. Slide the **two** batteries supplied into the battery holder, ensuring that the + side is uppermost on each battery as it is installed.

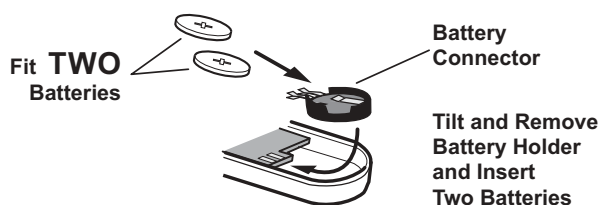

3. If necessary, refit the battery holder into the detector ensuring that the spring clip connectors slide onto either side of the circuit board.

The Detector should be mounted on the fixed part of the frame and the magnet on the opening part.

The Detector and Magnet should be mounted using the double sided adhesive pads or screws provided.

Note: If mounting the device using the adhesive pads, ensure that the mounting surfaces are clean and dry before mounting.

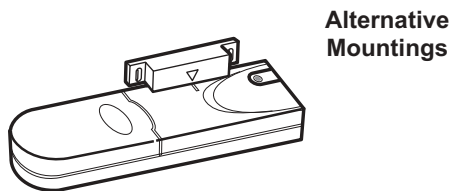
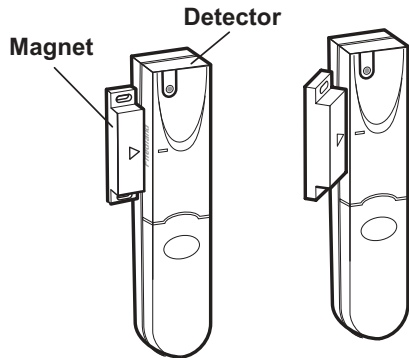

- If fixing the detector with screws first remove the battery holder by carefully tilting up the end and pulling away from the printed circuit board (PCB).

The top of the Detector is secured by hanging the keyhole slot over the head of the 10mm pan head screw. The bottom of the Detector is secured using the 12mm counter-sunk head screw fitted within the battery compartment. Carefully drill out the centre of the fixing screw hole in the battery compartment using a 3mm drill. Fit the Magnet using the two 15mm fixing screws. Do not over-tighten the screws as this may distort or damage the casing.

- If an additional wired Magnetic Contact is required, this should be wired to the terminal block provided in the battery compartment. The wired contact should be connected using a maximum length of 1.5 metres of any of the following:
 - 6 core alarm cable
 - 2 core bell wire (6 x 0.2mm minimum)
 - 2 core 24AWG wire

A cable entry cut-out is provided beside the terminal block in the battery cover.

- Switch SW3 is used to enable/disable the internal/external wired magnetic contact.

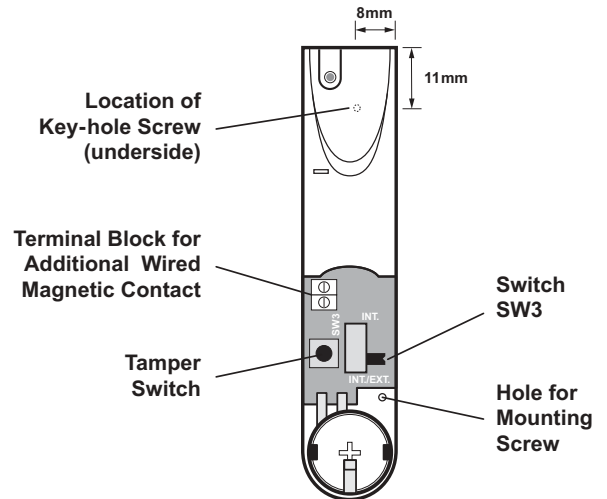

Position of SW3	Function
INT.	Internal Contact ON
INT./EXT.	Internal and External Contacts ON

- Set the magnetic contact detector by setting the position of the switch (SW3).

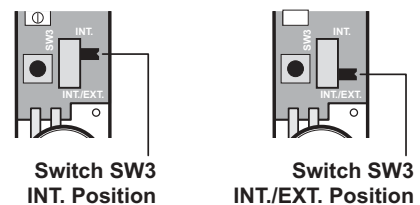

If setting to the INT. position, only the internal contact will be active. When two contacts are in use for internal and external connection simultaneously (INT./EXT. position), only one activation will be counted if one of the contacts is opened. If one contact is left open and the other closed contact is opened then an activation will be counted.

If using external contacts wired to the Detector, set to the INT./EXT. position.

IMPORTANT: If not using external contacts, set to the INT. position for the Detector to operate correctly.

- Refit the battery cover.

TESTING THE MAGNETIC CONTACT DETECTOR

9. Remove battery cover to activate the tamper switch.

As the button is released the LED indicator will illuminate for approximately 1 second to show that the tamper switch has been triggered and a signal is being transmitted.

10. Open the door/window to remove the Magnet from the Detector.

As the Magnet is moved away from the Detector the LED indicator will illuminate for approximately 1 second to show that the Detector has been triggered and a signal is being transmitted.

Note: It does not matter if the LED indicator illuminates as the magnet is brought towards the detector.

IMPORTANT: With the battery cover fitted the LED indicator will not flash when the door / window is opened, (unless the battery is low).

11. In order to communicate with the Siren, the ID code of the Detector needs to be learned by the Siren. By pressing the tamper switch either located adjacent to the PCB or the rear cover of the Detector will emit the ID code subject to the Siren being placed in Learn Mode. Refer to Adding a new PIR/Magnetic Door/Window Contact Detector to the Siren opposite.
12. Refit the battery cover.
13. Switch the Siren into Operating Mode (see page 19).

ADDING A NEW PIR OR MAGNETIC (MAG) DOOR / WINDOW CONTACT DETECTOR TO THE SIREN

IMPORTANT: In order to communicate with the Siren, the ID code of the Detector needs to be learned by the Siren. Whenever the Siren is being set-up it will automatically enter **Service Mode** when it is powered-up, ready to learn a new Detector. Alternatively if the Siren is already in **Operating Mode**, see page 19 to place the Siren into **Service Mode** before adding a new Detector.

1. Place the Siren into **Learn Mode** using a linked Remote Control or Remote Keypad:

- a) **Remote Control**

Press and hold the  button for 5 seconds or

- b) **Remote Keypad**

Enter the Keypad Access Code then press-and-hold the ARM button for 5 seconds

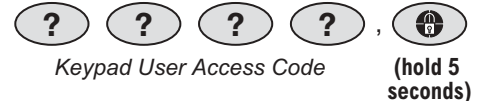

When the Siren enters Learn Mode it emits a single short beep and the both the indicator LEDs and Learn LED will flash together slowly (once every 2 seconds). The siren will remain in Learn Mode for 30 seconds.

2. a) Press the Tamper Switch on the PIR/MAG once.

If a valid signal is not received from a device in that period it will automatically exit Learn Mode. It will remain in Service Mode.

If the detector is new and not already linked to the alarm zone the siren will produce two short low volume beeps and the Indicator/ Learn LEDs will start flashing together rapidly, (once every second).

Note: If the detector is already linked to the siren or if there are already the maximum 12 detectors already linked to the siren then the siren will produce a single long low volume beep and exit Learn Mode. The Learn/Indicator LEDs will stop flashing.

- b) Confirm the new device ID code by activating the Tamper Switch again on the PIR/MAG detector within 15 seconds.

The siren will produce three short low volume beeps and the Indicator/Learn LEDs will stop flashing and remain ON for 3 seconds after which it will go out.

Note: If the valid signal is not received within 15s the Indicator/Learn LEDs will stop flashing and turn off and the siren will produce a single long low volume beep and exit Learn Mode.

- 3. The new PIR/MAG is now linked to the Siren and its ID code recorded into the Sirens memory. The siren will now return to Service Mode.

DELETING ALL DEVICES FROM THE SYSTEM

Note: NVM reset can only be achieved at the siren, it cannot be activated remotely from a linked Remote Control or Keypad.

To **delete all devices** from the system

1. Switch the Solar Siren into Service Mode using any Remote Control or Remote Keypad already linked so it can be removed from the wall.
2. Inside the battery compartment press-and-hold the learn button for 10s until the siren produces two long low volume beeps and the learn LED beside the learn button flashes 5 times. Ignore the learn beep after the first 5 seconds. The ID codes of all linked devices are now erased from memory.

Note: The siren will now remain in Service Mode as it cannot be switched to Operating Mode until a remote control or keypad is linked to it which allows it to be controlled.

SIREN SERVICE / OPERATING MODE

Note: The Siren is automatically in Service Mode when first powered up and must be switched into Operating Mode before the system can be operated or fully tested.

The siren can be switched between Service Mode and Operating Mode using any linked Remote Control or Keypad as follows:

Remote Control:

Press and hold the  button for 5 seconds:

Remote Keypad:

Enter the User Access Code, then press and hold the DISARM button for 5 seconds:

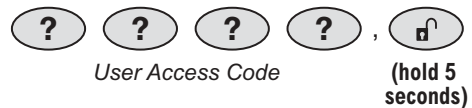

The siren will generate the following signals to indicate which mode it is switching into...

If switching into **Service Mode**:

As the  button is pressed the Remote will transmit the Disarm signal and the Siren will beep twice as normal. This Disarms the system.

After the  button has been held down for 5 seconds the "Siren Service Mode Toggle" command will be transmitted and the siren will produce two short beeps followed 1 second later by a single long beep. The Siren LEDs will flash together in conjunction with the beeps. Beeps to be normal volume.

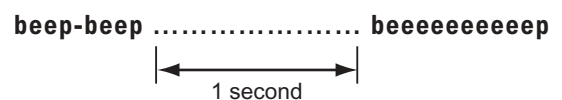

If switching into **Operating Mode**:

As the  button is pressed the Remote will transmit the Disarm signal. The siren will not respond to this as it is in Service Mode.

After the  button has been held down for 5 seconds the "Siren Service Mode Toggle" command will be transmitted and the siren will produce a single long beep followed 1 second later by two short beeps. The Siren LEDs will flash together in conjunction with the beeps. Beeps to be normal volume.

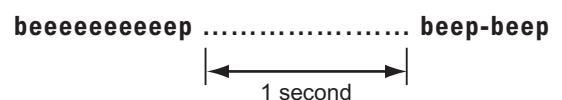



Note: The siren will return to Operating Mode into a Disarmed condition.

TESTING THE SYSTEM

The system should be tested at regular intervals (at least every 3 months), to ensure that it is operating correctly.

1. Before commencing testing please ensure the following:
 - The Siren is in Operating Mode and Disarmed.
 - There is no movement or people/pets in any PIR protected area.
 - All doors/windows protected by Magnetic Contact Detectors are closed.
 - All battery covers and housings are correctly fitted.

If your system includes a Remote Control:

2. Press the  button on the Remote Control
The Siren will beep once.
3. Activate the PA switch on the Remote Control by sliding it forward.
The alarm will sound.
4. Stop the alarm by pressing the  button on the Remote Control.
The Siren will stop and acknowledge the signal by beeping 10 times, (unless Beep Disable has been selected).

If your system includes a Keypad:

5. Arm the system at the Keypad by entering your User Access Code followed by the 'INSTANT-ARM' button.



The Siren will beep once.

6. Press and hold both 'DELAY-ARM' buttons on the Keypad for approximately 3 seconds.

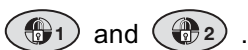

The alarm will sound.

7. Stop the alarm and Disarm the system by entering your User Access Code followed by the 'DISARM' button on the Keypad.



If your system includes PIR Detectors:

8. Arm the system in Instant-Arm mode by pressing the  button on the Remote Control.

The Siren will acknowledge the signal by beeping once, (unless Beep Disable has been selected).

9. Ensure that the area protected by the PIR has been free from movement for at least 2 minutes and then walk into the area to trigger the detector.

Note: To conserve power the PIR will only detect movement if there has been no movement detected within the previous 2 minutes.

10. Stop the alarm and Disarm the system by pressing the  button on the Remote Control.

The Siren will stop and acknowledge the signal by beeping 10 times, (unless Beep Disable has been selected).

11. Continue to test all PIR Detectors in turn as described above, (steps 8 - 10).

If your system includes Magnetic Contact Detectors:

12. Arm the system in Instant-Arm mode by pressing the  button on the Remote Control.

13. Open a door/window protected by a Magnetic Contact Detector and ensure that the alarm sounds.

14. Disarm the system and stop the Siren by pressing the  button on the Remote Control.

15. Test each Magnetic Contact Detector in turn as described above, (steps 12 - 14).

OPERATING INSTRUCTIONS

When leaving the premises, the system must be Armed. However, before doing so, check that all windows are closed and locked, all protected doors are closed and PIR Detectors are not obstructed. Ensure that pets are restricted to areas not protected by PIR Detectors.

The system has 2 armed modes, Instant-Arm and Delay-Arm.

Instant-Arm mode will immediately Arm the system. Once the system is Armed, activating any detector, (i.e. opening a door/windows protected by a Magnetic Contact Detector or moving into a PIR protected area), will immediately trigger an Alarm. On returning to and entering the property the system must be Disarmed before opening any protected door or entering an area protected by a PIR Detector otherwise an Alarm will occur. For this reason when using Instant-Arm mode, the system should be Armed and Disarmed from outside the property using the Remote Control.

Delay-Arm mode will Arm the system with a 15 second entry/exit delay. On arming the system in Delay-Mode the siren will beep once and then again after the 15 second delay has expired. This allows time for you to leave the property before the system becomes fully Armed. On returning to and entering the property by opening a protected door or moving through a PIR protected area the system will be triggered and the Siren will emit a single long beep. However, an Alarm will not sound until the 15 second delay has expired. The system must be Disarmed using either the Remote Control or Keypad during the 15 second delay to prevent the Alarm from sounding.

If an Alarm occurs the Siren will sound continuously until the set alarm duration time expires. The alarm will then stop and the system will automatically re-arm itself. This process can be repeated up to 3 times after which time the "Alarm Lockout" feature will operate and prevent the system from re-arming.

Notes:

- To conserve power and maximise battery life the PIR Detector will only detect movement if there has been no movement detected within the previous 2 minutes.
- The system can only be armed if the Siren is in Operating Mode, (see page 19).

ARMING THE SYSTEM IN INSTANT-ARM MODE

The system can be Armed in Instant mode by using either the Remote Control or the Keypad as follows:

Remote Control:

Press the 'INSTANT-ARM' button, 

Remote Keypad:

Enter your User Access Code followed by the 'INSTANT-ARM' button

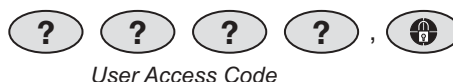

The Siren will acknowledge the signal by beeping once and flashing both indicator LEDs once.

ARMING THE SYSTEM IN DELAY-ARM MODE

The system can be Armed in Delay mode using either the Remote Control or the Keypad as follows:

Remote Control:

Press the 'DELAY-ARM' button, 

Remote Keypad:

Enter your User Access Code followed by either 'DELAY-ARM' button.

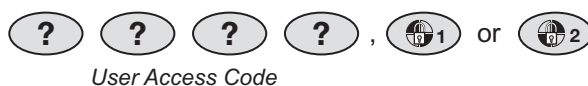

The Siren will acknowledge the signal by beeping once and flashing both indicator LEDs once. After the fixed 15 seconds exit-delay has expired the siren will produce a second single beep and flash both LEDs again to indicate the system is fully armed. The alarm cannot be triggered by activating and PIR/MAG detector during the 15 seconds exit-delay.

If a PIR/MAG detector is triggered while the system is armed in Delay-Arm mode the siren will produce a single long beep and long flash of both LEDs. However the alarm will not sound until the end of the fixed 15 second entry-delay. If the system is Disarmed before the entry-delay expires the alarm will not sound.

DISARMING THE SYSTEM

The system can be Disarmed using either the Remote Control or the Keypad as follows:

Remote Control:

Press the 'DISARM' button, 

The Siren will acknowledge the signal by beeping twice.

Remote Keypad:

Enter your User Access Code followed by the 'DISARM' button.



User Access Code

The Siren will acknowledge the signal by beeping twice.

IMPORTANT: If, when the system is Disarmed, the Siren emits a series of 10 rapid beeps, this indicates that an Alarm has been triggered whilst the system was Armed. Check the security of the property before entering.

PERSONAL ATTACK (PA) ALARM

An Alarm can be immediately triggered by the user at any time (whether the system is Armed or Disarmed) in the event of threat or danger by activating the Personal Attack (PA) facility using either the Remote Control or the Keypad as follows:

Remote Control:

Slide the Personal Attack switch upwards.

Remote Keypad:

Press and hold both the  and  buttons together for 3 seconds.

This will trigger the alarm and the Siren will sound.

DEVICE TAMPER

If the battery cover of any device (except a Remote Control) is removed or if the Siren or Keypad are removed from the wall then an Alarm will immediately occur (unless the Siren is in Service Mode), even if the system is Disarmed.

The Alarm will sound until the set alarm duration time expires or the system is Disarmed from the Remote Control or Keypad.

SIREN SERVICE MODE

In order to remove the Siren from the wall to change the batteries, it is necessary to place the Siren into Service Mode to prevent the Tamper protection switch on the Siren operating and triggering an alarm (see page 19).

SIREN OPERATING MODE

When you have completed any alterations to the system remember to switch the Siren into Operating Mode.

The Siren can be switched into Operating Mode using either the Remote Control or the Keypad (see page 19).

BATTERY MONITORING

Low Battery Condition

If the Siren is at low battery condition, pressing the Disarm button on the Remote Control or Keypad will cause the Siren to generate 3 short beeps.

All system devices continuously monitor their battery condition. When a low battery indicator is activated the device will continue to operate normally for up to 2 weeks (depending upon system use). However, the battery for that device should be replaced as soon as possible.

Before replacing the battery in any device you must switch the system into Service Mode as previously described. When the batteries have been replaced, you must return the system to Operating Mode. See page 19.

The low battery indication built into each system device is as follows:

Remote Control

When the Remote Control is operated under low battery conditions the transmit LED will continue to flash after the button has been released.

Under normal battery conditions the LED will extinguish within 2 seconds of the button being released.

Remote Keypad

When the battery is low the 'low-batt' LED on the keypad will be illuminated.

Note: The Keypad will retain your User Access Code setting for approximately 15 seconds whilst the battery is removed and replaced. If the battery is left disconnected for a longer period, or has been allowed to run completely flat your User Access Code will revert to the factory set code of "1234" when the new battery is connected. The User Access Code will then need reprogramming as detailed on page 9.

PIR Movement Detectors

Under low battery conditions the LED behind the detector lens will flash when movement is detected to indicate that the battery needs to be replaced.

Under normal battery conditions the LED does not illuminate unless the PIR Detector is in Walk Test Mode.

Magnetic Contact Detectors

When the Detector is activated, under low-battery conditions the Transmit LED will be illuminated for approximately 1 second as the door/window is opened.

Under normal battery conditions the LED does not illuminate as the Detector is operated, (unless the Detector is in Test Mode with the battery cover removed).

MAINTENANCE

Your Alarm System requires very little maintenance. However, a few simple tasks will ensure its continued reliability and operation.

IMPORTANT: If, for any reason you have to completely power-down the system (e.g. to move the system to new premises), first put the system into Service Mode before removing the Siren cover and disconnecting the main rechargeable and initial power-up batteries. Ensure that the solar panel is covered with a lightproof material to prevent it being energised, otherwise the solar panel may still power the siren.

SOLAR SIREN

1. It is recommended that the solar panel on the top of the siren housing should be cleaned at least twice a year, preferably in the Spring and Autumn, using a soft damp cloth. Do not use abrasive, solvent based or aerosol cleaners. Do not attempt to clean inside the unit or allow water to enter the unit.

This will ensure that the solar panel does not become affected by the build up of excessive dirt and receives all the available light.

2. The Siren should not be left for long periods with the batteries connected, unless the unit is able to receive sufficient light to maintain the battery charge. Failure to maintain charge to the unit will result in the rechargeable battery running unacceptably low. Should this occur, the unit must be recharged from a 7.5Vdc/100mA supply (e.g. from a mains adaptor power supply). When re-powering the Siren, fit a new 9V PP3 leak-proof Alkaline power-up battery to ensure that the Siren receives sufficient power until the solar panel can recharge the main battery.
3. The main rechargeable battery has a typical life of 3 - 4 years and needs no maintenance during this period, provided the battery is kept charged. The battery will be damaged if it is stored in a discharged state for long periods.

IMPORTANT: Before removing the Siren from the wall ensure that the Siren is first switched into Service Mode to prevent the Tamper switch

operating and triggering an alarm, (see page 19). The Siren must be switched back into Operating Mode, otherwise the system cannot be Armed.

DETECTORS, REMOTE CONTROL AND KEYPAD

The Detectors, Remote Control and Keypad require very little maintenance. The batteries should be replaced once a year or when a low battery status is indicated.

BATTERIES

Note: Before removing the battery cover on any device to replace the battery ensure that the Siren is switched into Service Mode to avoid triggering an alarm. The Siren must be switched back into Operating Mode after fitting new batteries otherwise the system will not operate.

The specifications for replacement batteries are as follows:

Remote Control:

1 x 3V CR2032 Lithium Cell (or equivalent)

Magnetic Contact Detector:

2 x 3V CR2032 Lithium Cells (or equivalent)

PIR Movement Detector:

1 x 9V PP3 Alkaline Battery

Keypad:

1 x 9V PP3 Alkaline Battery

Note: Rechargeable batteries should NOT be fitted.

DISPOSAL

At the end of their useful life the packaging, product and batteries should be disposed of via a suitable Recycling Centre.

Do not dispose of with your normal household waste. **DO NOT BURN.**



The Rechargeable Batteries contain Sulphuric Acid – **DO NOT ATTEMPT TO OPEN THE CASING.**

TROUBLE SHOOTING

Symptom / Recommendation

Siren immediately sounds when system armed.

1. Siren tamper switch activated - adjust tamper plunger and ensure that switch fully closes when Siren is mounted. If the wall is excessively uneven, the Siren may need relocating to a more suitable position.

Siren sounds when system is disarmed or has not been triggered by an intruder.

1. Detector tamper switch activated - check that the battery covers of all Detectors and Keypads to ensure they are securely and fully fitted.
2. Personal Attack Alarm operated from a Remote Control or Keypad.
3. Jamming Detection circuit operation (see page 11).
4. Detector giving false alarm signals, see below.

Siren not responding to Detector.

1. Siren is in Service Mode - switch to operating Mode (see page 19).
2. Detector battery low - Replace battery.
3. Ensure 'ID code' of the Detector has been learnt by the Siren (see page 18).
4. Ensure Detector is within effective radio range of Siren and equipment is not mounted close to metal objects.

Siren not responding to Remote Control or Keypad.

1. Siren is in Service Mode - switch to operating Mode (see page 19).
2. Remote Control or Keypad battery low - Replace battery.
3. Ensure 'ID code' of the Detector has been learnt by the Siren (see page 18).
4. Incorrect User Access Code being entered at Keypad.

5. Siren rechargeable battery discharged:
 - a. Clean Solar Panel.
 - b. Check age of rechargeable battery - replace if at end of useful life.
 - c. Fit new initial power-up battery and re-power up Siren.
6. System locked - Reset system:
 - a. Disconnect Siren rechargeable and initial power-up batteries.
 - b. Cover Solar Panel with lightproof material and leave system for 5 minutes.
 - c. Reconnect batteries and then remove Solar panel cover and take out of Service Mode.

LED on Remote Control not illuminating, or is dim when unit is operated.

1. Ensure battery is fitted with correct polarity.
2. Ensure battery holder connections are making good contact with the battery.
3. Battery low - replace battery.

Keypad not operating (■■■ light does not illuminate).

1. Incorrect User Access Code being entered.
2. Battery missing.

PIR Movement Detector false alarming.

1. Ensure that the detector is not pointing at a source of heat or a moving object.
2. Ensure that the detector is not mounted above a radiator or heater.
3. Ensure that the detector is not facing a window or in direct sunlight.
4. Ensure that the detector is not in a draughty area.
5. Sensitivity set too HIGH - reset to LOW sensitivity, (i.e. SW3 to down position).

PIR Movement Detector not detecting a person's movement.

1. Ensure the battery clip is securely connected.
2. Ensure 'ID code' of the Detector has been learnt by the Siren (see page 18).
3. Sensitivity set too LOW - reset to HIGH sensitivity, (i.e. SW3 to up position).
4. Ensure that detector is mounted the correct way up, (i.e. with detection window at the bottom).
5. Ensure that the detector is mounted at the correct height, (i.e. 2 - 2.5 metres).
6. Once the system is armed allow up to 3 minutes for the detector to stabilize and become fully operational. Leave the area for this period.

If the system is armed with a delay allow a further 15 seconds to ensure that the Entry delay period has expired.
7. Ensure detector is within effective radio range of the Siren and is not mounted close to metal objects which may interfere with the radio transmission.

PIR Movement Detector LED flashes on detection of movement, (device in Normal Operation Mode).

1. Low battery - Replace battery.
2. PIR still in Walk Test Mode for fixed 5 minutes if the PCB button was activated (see page 15).

Magnetic Contact Detector not working.

1. Ensure that Magnet is correctly positioned in relation to Detector and that the gap between magnet and detector is less than 10mm.
2. Ensure batteries are fitted with correct polarity.
3. Ensure battery holder connections are making good contact with the batteries and PCB (Circuit board).
4. Ensure 'ID code' of the Detector has been learnt by the Siren.

5. If there is no additional wired Magnetic Contact connected ensure switch SW3 is set to (INT.) internal contact ON.
6. If an additional wired Magnetic Contact is connected:
 - a. Check that both contacts are closed.
 - b. Check that additional contact is correctly wired and switch SW3 set to the INT./EXT. position.

Note: If a wired contact is used, both protected doors/windows **must** be closed when the system is armed (otherwise neither door/window will be protected).
7. Ensure detector is within effective radio range of the Siren and is not mounted close to metal objects which may interfere with the radio transmission.

Magnetic Contact Detector false alarming.

1. Ensure that Magnet is correctly positioned in relation to Detector.
2. Ensure that gap between Magnet and Detector is less than 10mm.
3. Tamper switch below battery cover not depressed - check battery cover is fitted correctly and that fixing lugs are not broken.

LED on Magnetic Contact Detector illuminating when door or window is opened.

1. Low battery - replace batteries.

HELPLINE

If you have any problems with your alarm, please call the Helpline on:

0870 850 3015

(Lines open 9.00am to 5.00pm, Monday to Friday.
Calls charged at service providers national rate).

EXTENDING YOUR ALARM SYSTEM

The following additional accessories are available to enhance your system and provide further protection and a higher level of security where required.

ACCESSORIES

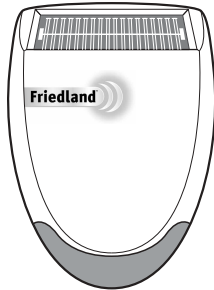

HS0
DUMMY SIREN

1 x Dummy Solar Siren

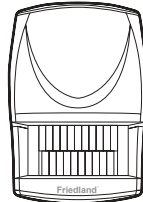

HS2
PIR MOVEMENT DETECTOR

1 x PIR Movement Detector



HS3
REMOTE CONTROL

1 x Remote Control

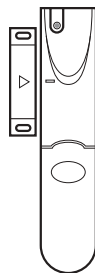

HS4
MAGNETIC CONTACT DETECTOR

1 x Magnetic Contact Detector

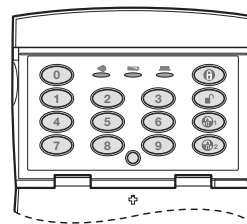

HS5
REMOTE KEYPAD

1 x Remote Keypad

GUARANTEE

Novar ED&S (A Honeywell Company) undertakes to replace or repair at its discretion goods (excluding non rechargeable batteries) should they become defective within 1 year solely as a result of faulty materials and workmanship. Understandably if the product has not been installed, operated or maintained in accordance with the instructions, has not been used appropriately or if any attempt has been made to rectify, dismantle or alter the product in any way the guarantee will be invalidated.

The guarantee states Novar ED&S entire liability. It does not extend to cover consequential loss or damage or installation costs arising from the defective product. This guarantee does not in any way affect the statutory or other rights of a consumer and applies to products installed within the UK and Eire only.

If an item develops a fault, the product must be returned to the point of sale with:

1. Proof of purchase.
2. A full description of the fault.
3. All relevant batteries (disconnected).

Friedland is a trademark of Novar ED&S.

COMPONENT SPECIFICATION

External Solar Siren

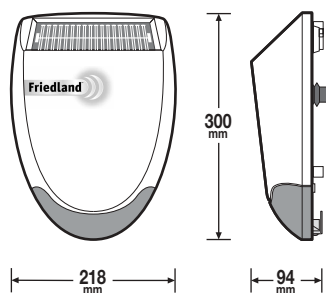

- RF operating frequency: 868MHz
- Sealed lead acid battery 6V/1.2Ahr
- Solar Panel 7.5V - Charge Rate typically 60mA
- Operation time in complete darkness - up to 25 days
- Instant-Arm mode
- Delay-Arm mode - 15 seconds Entry/Exit Delay
- High Power Piezo Siren
- Alarm Duration: 1 or 3 minutes
- Auto reset
- Alarm lockout
- Siren Disable
- Rear anti-tamper protection
- Jamming Detection
- Audible confirmation

Remote Control

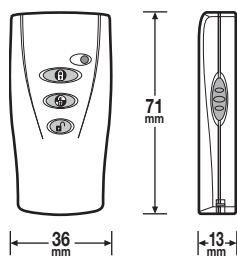

- RF operating frequency: 868MHz
- Range: 80 metre max.
- Personal Attack (PA) switch
- Operates all ARM, DELAY-ARM and DISARM functions
- Transmission indicator
- Battery life >1 year
- Low battery indicator

Keypad

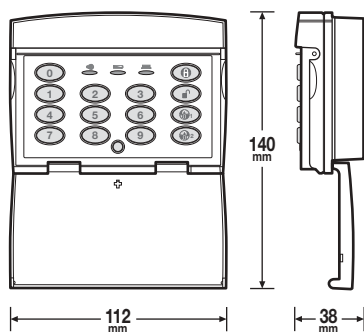

- RF operating frequency: 868MHz
- Range: 125 metre max.
- Changeable 4 digit User Access Code.
- Anti-tamper protected
- Personal Attack (PA) facility
- Battery life >1 year
- Low battery indicator

PIR Infra-Red Movement Detector

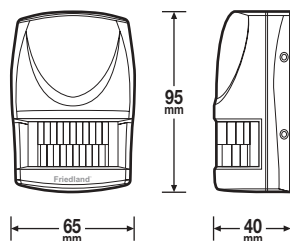

- RF operating frequency: 868MHz
- Range: 150 metre max.
- Detection range: 12 metres at 110°
- Walk test facility
- LOW/HIGH Detection Sensitivity
- Anti-tamper protected
- Corner or surface mount
- Battery life >1 year
- Low battery indicator

Magnetic Contact Detector(s)

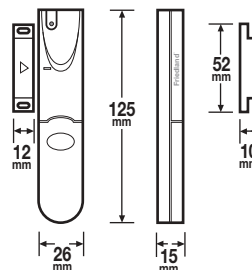

- RF operating frequency: 868MHz
- Range: 150 metre max.
- Test Mode
- Anti-tamper protection
- Facility to connect additional wired Magnetic Contact
- Battery life >1 year
- Low battery indicator

RESEARCH & DEVELOPMENT

Our R & D Department is constantly developing new products. We practice a policy of continued improvement and reserve the right to change specifications without prior notice.

Novar Electrical Devices and Systems are Quality Assurance Registered to BS EN ISO9001 2000, by Asta.

HELPLINE

If you have any problems with your alarm, please call the Helpline on:

0870 850 3015

(Lines open 9.00am to 5.00pm, Monday to Friday. Calls charged at service providers national rate).



Friedland, Novar Electrical Devices and Systems Limited. (A Honeywell Company)

The Arnold Centre, Paycocke Road, Basildon, Essex SS14 3EA. UK

www.friedland.co.uk

51062PL Ed.4