

## Wirefree Keypad

### Installation and Operating Instructions

These instructions should be read in conjunction with your System Installation and Operating Manual and be retained for future reference.

#### DECLARATION

Friedland hereby declares that this wirefree PIR Detector is in compliance with the essential requirements and other relevant provisions of the R&TTE directive (1999/5/EC).

#### INTRODUCTION

This Keypad is suitable for use with Friedland Response Wirefree Intruder Alarm systems operating at 868MHz only.

The Keypad is used to control the Siren and to Arm and Disarm the system by entering a 4 digit User Access Code.

The Keypad incorporates a tamper protection facility to protect against unauthorised attempts to open or remove it from the wall. In addition the keypad includes tamper protection against repeated attempts to find the Access Code by continuously entering code at random.

The Keypad also incorporates a Personal Attack (PA) facility that will immediately trigger an alarm when activated, (unless the Siren is in Service Mode).

The Keypad is powered by a PP3 Alkaline battery which under normal conditions will provide an expected life of approximately 1 year. When the battery level drops, the "LOW BATT" LED on the front of the Keypad will flash. When this occurs the battery should be replaced as soon as possible.

#### POSITIONING THE WIREFREE KEYPAD

The Keypad is suitable for mounting in dry interior locations only.

The Keypad should be mounted in a position close to the main entrance door so that the User Access Code can be entered and the alarm system shut down within the 15 seconds entry time period. The alarm system should be designed so that the Keypad is located within a protected area so that it cannot be reached without triggering an alarm.

It should be mounted on a sound flat surface so that the mounting plate is not distorted and using all four fixings so that the tamper switch does not cause false alarms.

Ensure that the Keypad is mounted within the 125m radio range of the Siren or Control Panel. Do not fix the Keypad onto or very close to metalwork (e.g. radiators, water pipes, etc) as this could affect the radio range of the device. Remember to take into account the reduction in range caused by any solid objects (e.g. walls, ceilings, PVC doors etc.) placed between the keypad and Siren.

Wall Type	Range Reduction
Dry-lined partition wall:	10 - 30%
Single layer brick wall:	20 - 40%
Double layer brick wall:	30 - 70%
Metal panel/radiator:	90 - 100%

#### INSTALLING THE WIREFREE KEYPAD

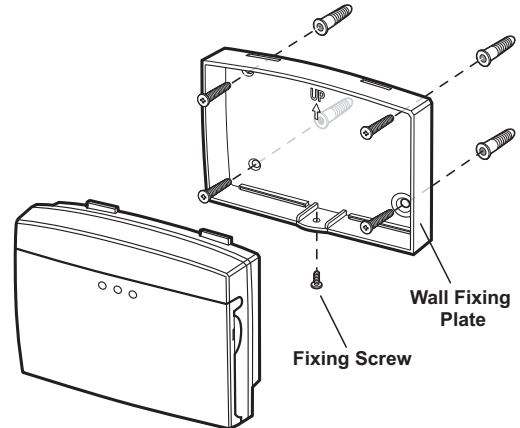

1. Undo and remove the fixing screw from the bottom edge of the Keypad and remove the wall mounting plate.
2. Using the mounting plate as a template, mark the positions of all four fixing holes on the wall. A small spirit level will ensure it is perfectly level.
3. Fix the mounting plate to the wall using the screws and wall plugs provided, (a 5mm hole will be required for the wall plugs). Fully tighten all screws taking care not to overtighten the screws as this may distort or damage the mounting plate.

**Note:** The wall plugs supplied with the product are not suitable for plasterboard walls, if mounting the Keypad onto plasterboard use appropriate wall plugs.

4. Undo the two fixing screws in the rear cover and remove the battery cover.

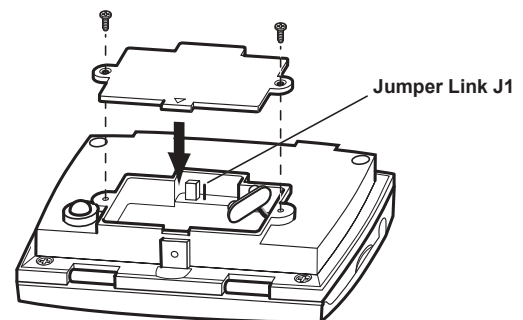

5. Press and hold any key for more than 1 second.
6. Located at the top of the battery compartment, there is a RESET jumper link. This should be set to the position shown (top).
7. Connect the PP3 alkaline battery to the battery clip and set the jumper link J1 shown (bottom) which is what the keypad is set to normally.

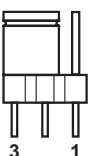
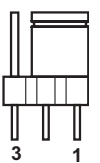

- Replace the rear cover and refit the fixing screws. Do not over-tighten the screws.
- Refit and secure the Keypad onto the wall mounting plate and fit the fixing screw in the bottom edge. Do not overtighten the screw.

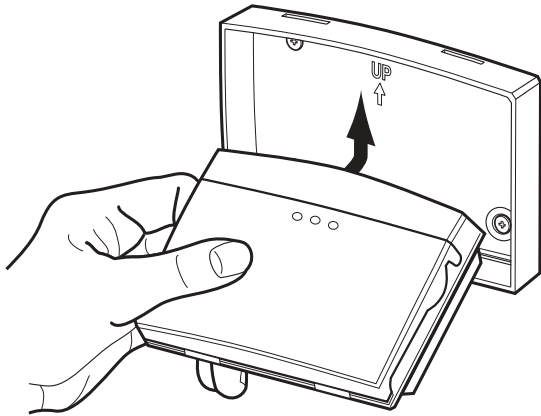

## LINKING THE KEYPAD TO YOUR SYSTEM

Ensure that the Control Panel is in Learn Mode (or the Siren is in Learn Mode for single zone systems without a Control Panel). Refer to the "Installation and Operating Manual" for your system for adding/learning a new Remote Keypad.

## TESTING THE KEYPAD

Ensure that the Solar Siren is in Operating Mode.

- Arm the system by entering the user access code followed by the Instant-Arm button.

Press **1** **2** **3** **4**  
Factory Default User Access Code

- Press and hold both Delay-Arm buttons together for approximately 3 seconds to activate the PA alarm.

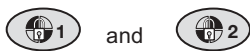

The alarm will sound.

- Stop the alarm and disarm the system by entering your user Access Code followed by the Disarm button.

Press **1** **1** **2** **3** **4** **1**  
Factory Default User Access Code

## CHANGING THE USER ACCESS CODE

Default Code: 1 2 3 4

To change the User Access Code, press the following keys in sequence:

- Press **1** **1** **2** **3** **4** **1**  
Factory Default User Access Code

The  LED will flash two times.

- Enter a new User Access Code of your choice:

**?** **?** **?** **?** **1**  
New User Access Code

The  LED will flash three times to confirm the setting has been accepted.

If the LED does not flash, wait 5 seconds and try steps 1 - 5 again.

## RESETTING THE USER ACCESS CODE

The Keypad should remember the User Access Code even when the battery is removed. If however you forget the User Access Code you can reset it to the factory default setting of 1234 as follows.

- Undo fixing screw at bottom of Keypad and remove it from wall mounting plate.
- Undo the two fixing screws and remove the battery cover.
- Remove the battery and then press and hold any key down for more than 1 second.
- Set jumper link J1 in the reset position shown.
- Refit the battery.
- The factory default User Access Code of 1234 should now be reset into the Keypad.

Press **1** **2** **3** **4**  
Factory Default User Access Code

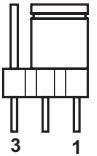

- The  LED should flash rapidly to show a correct code has been entered.

- Set the Jumper link J1 in the normal operation position shown:

- Replace the battery cover and refit the screws and then secure the Keypad back onto the wall bracket.

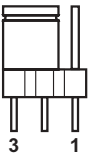

## OPERATING INSTRUCTIONS

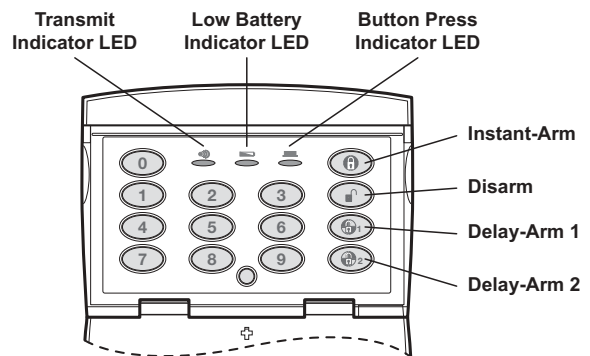

When using the Keypad the buttons must be pressed firmly and within five seconds of each other. If you make a mistake, wait ten seconds and start again.

When a button is pressed the  LED will illuminate.

The Keypad has back light will illuminate the keypad buttons for 5 seconds when the cover is first opened or for 5 seconds after any key is pressed.

## INSTANT-ARM

Press     ,   
Current User Access Code

## INSTANT-ARM



Press     ,   
Current User Access Code

## DELAY-ARM

Press     ,   
Current User Access Code



## TAMPER

The Keypad incorporates tamper protection feature to protect against unauthorized attempts to remove it from the wall. If it has been removed from the wall, an alarm will immediately occur, (provided the siren is not in service mode).

In addition if a sequence of more than 16 keys are pressed without a valid code being entered the  LED will flash slowly and the Keypad will be disabled for the next 1 minute. If the keypad is disabled like this three consecutive times without a valid code being entered the  LED will flash slowly and an alarm will be triggered at the siren, (provided the siren is not in service mode)

## PERSONAL ATTACK/PA





Default Code: ON

Press and hold both  and  together for more than 3 seconds.

The  LED will flash rapidly if both buttons are pressed at the same time.

## SOLAR SIREN SERVICE MODE

To switch the Siren into Service Mode.

Press     ,   
Current User Access Code (hold 5 seconds)

After approximately 5 seconds The siren will produce a single long beep followed 1 second later by two short beeps. The Siren LEDs will flash together in conjunction with the beeps. The button must be released during or immediately after the long beep, otherwise the system will switch into an Armed state.

## MAINTENANCE

The product may be cleaned with a soft damp cloth and then wiped dry. Do not use abrasive, solvent based or aerosol cleaners as this may damage and/or discolour the product. Do not allow water to enter or attempt to clean inside the unit.

## Batteries

Do not allow batteries to corrode and leak as this may cause permanent damage to the product.

The  LED indicator on the front of the Keypad will start flashing when the Keypad battery level drops too low. A new battery as specified below should be fitted as soon as possible.

## Replacement Battery

1 x 9V PP3 (6LR61) Alkaline Battery



Do not fit a rechargeable battery.

## Procedure for Changing Battery

1. Enter the User Access code twice in succession

    , followed by  
Current User Access Code

     
Current User Access Code

The  and  LEDs will flash together for 20 seconds during which time the Keypad will be disabled and will not transmit any signals to the siren.

2. Immediately undo fixing screw at bottom of Keypad and remove it from wall mounting plate during this period while the LEDs are flashing.

**IMPORTANT:** When the LEDs have stopped flashing take care not to press the tamper switch plunger on the rear of the Keypad while changing the battery otherwise an alarm will occur.

3. Undo the two fixing screws in the rear cover and remove the battery cover.
4. Replace the battery with a new 9V PP3 Alkaline battery.
5. Replace the battery cover and refit the screws and then secure the Keypad back onto the wall bracket.

After replacing the battery, test the keypad to ensure that the User Access Code is still correctly programmed. If the code is lost then it should be reprogrammed and tested to ensure correct functionality before use.

**Note:** Alternatively and of in doubt switch the solar siren into service mode before attempting to open the keypad to change the battery. Remember to switch the siren back to operating mode afterwards.

## TROUBLESHOOTING

### Symptom / Recommendation

#### **Keypad doesn't operate – LED doesn't illuminate when any key pressed.**

1. Battery missing or flat. Fit new battery.

#### **Keypad doesn't operate – LED flashing.**

1. Low Battery level. Fit new battery.









#### **Keypad doesn't operate – Keypad will not transmit LED doesn't illuminate.**

1. Incorrect User Access Code being entered. Wait 20 seconds and re-enter key sequence with correct user code.

#### **Siren not responding to Keypad.**

1. Keypad house code not or incorrectly programmed. Reprogram house code.
2. Keypad configured for multi zone system. **Set jumper J3** correctly.
3. Siren setup error. Check trouble shooting guide in main system manual for siren problems.

#### **Keypad Personal Attack / PA feature doesn't function.**

1.  and  not pressed down at same time, (LED not flashing rapidly). Press  and  together so that the  LED flashes rapidly.
2.  and  not being held down long enough. Hold keys down for more than 3 seconds until the  LED flashes rapidly.

#### **Keypad Tamper Switch Activates Inadvertently.**

1. Wall mounting plate on no flat wall and distorted. Refit on flat surface; use spacers behind plate if necessary.
2. Wall mounting plate loose and not secure. Fix mounting plate to wall with all four screws and fully tighten all screws
3. Keypad not secured to Wall Mounting Plate. Fully tighten fixing screws on lower edge of keypad.

## DISPOSAL

At the end of their useful life the packaging, batteries and product should be disposed of via a suitable Recycling Centre. Do not dispose of with your normal household waste. DO NOT BURN.



## GUARANTEE

Novar ED&S (A Honeywell Company) undertakes to replace or repair at its discretion goods (excluding non rechargeable batteries) should they become defective within 2 years solely as a result of faulty materials and workmanship. Understandably if the product has not been installed, operated or maintained or maintained in accordance with the instructions, has not been used appropriately or if any attempt has been made to rectify, dismantle or alter the product in any way the guarantee will be invalidated.

The guarantee states Novar ED&S entire liability. It does not extend to cover consequential loss or damage or installation costs arising from the defective product. This guarantee does not in any way affect the statutory or other rights of the consumer.

If an item develops a fault, the product must be returned to the point of sale with:

1. Proof of purchase.
2. A full description of the fault.
3. All relevant batteries (disconnected).

Friedland is a trade mark of Novar ED&S.

## HELPLINE

If you have any problems with your alarm, please call the Helpline on:

# 0870 850 3015

(Lines open 9.00am to 5.00pm, Monday to Friday. Calls charged at service providers national rate).



Friedland, Novar Electrical Devices and Systems Limited. (A Honeywell Company)

The Arnold Centre, Paycocke Road, Basildon, Essex SS14 3EA. UK

[www.friedland.co.uk](http://www.friedland.co.uk)

51069PL Ed.1