

ResponseTM

36 Zone Wireless Security System SL5



Installation & Operating Manual

FOREWORD

All devices in this wireless Alarm System are designed and manufactured to provide long reliable service. The system is designed for ease of installation using only conventional domestic tools. However, it is essential that the installer reads and fully understands the advice and procedures contained in this manual and plans the system before proceeding with the installation.

During installation, it is important that the procedures described in this manual are followed in sequence.

This manual should be retained in a safe place for future reference.

IMPORTANT: All devices, with the exception of the External Siren are suitable for mounting in dry interior locations only.

IMPORTANT:

LOCAL AUTHORITY REGULATIONS AND LEGISLATION

This alarm system should be installed and operated in accordance with the requirements of any current local and/or national regulations and legislation. We recommend that you contact your authority to obtain details of your area's requirements regarding intruder alarm installations.

For example in Belgium, the installation and use of an alarm system including notification by telephone (Voice Dialler) functionality and the optional use of an external siren is controlled by Belgium legislation "KB" of 19/06/2002.

DECLARATION

Novar ED&S hereby declares that this wireless alarm system is in compliance with the essential requirements and other relevant provisions of the Radio and Telecommunications Terminal Equipment (R&TTE) directive, 1999/5/EC.

Tools and Equipment Required:

No.0 Philips Screwdriver	Bradawl
No.1 Philips Screwdriver	Drill
No.2 Philips Screwdriver	3mm Drill Bit
Small Spirit Level	5 & 6mm Masonry Drill Bits

DEVICE RANGE

The quoted range of the system devices (see component specification on rear cover) is measured in ideal conditions. Any solid object (e.g. walls, ceilings, reinforced PVC doors etc) placed between the transmitter and Receiver device will reduce the radio range.

The amount by which the range will be reduced is dependant upon the nature of the barrier.

For example:

Wall Type	Range Reduction
Dry-lined partition wall:	10 - 30%
Single layer brick wall:	20 - 40%
Double layer brick wall:	30 - 70%
Metal panel/radiator:	90 - 100%

Note: The effect on the range of multiple walls is cumulative, i.e. if there are 2 brick walls in the way, the range will be reduced by up to 40% by each wall.

SYSTEM SECURITY

This system has been designed to both detect intruders and act as a strong deterrent to would-be intruders when installed correctly.

We recommend that your Alarm is used in conjunction with good physical protection such as security window and door locks.

All units in the system are encoded to operate together using a 20 bit House Code.

The system is operated from one or more Remote Control Units and/or Keypads - depending on which system and/or accessories purchased.

SAFETY

Always follow the manufacturers advice when using power tools; steps, ladders etc. and wear suitable protective equipment (e.g. safety goggles) when drilling holes etc.

Before drilling holes in walls, check for hidden electricity cables and water pipes, the use of a cable/pipe locator maybe advisable if in doubt.

When using ladders, ensure that they are positioned on a firm stable surface at the correct angle and suitably secured before use.

The use of ear defenders is advisable when working in close proximity to the Siren due to the high sound level produced by this device.

CONTENTS

KIT CONTENTS	4	TESTING THE SYSTEM	26
INTRODUCTION AND OVERVIEW	5	FACTORY SETTINGS	31
Multiple Users	5	Reset Factory Settings	31
User Access Code	5	PROGRAMMING INSTRUCTIONS	32
System Arming	5	Navigating through the Programming Mode Menus	32
Entry/Exit Delay	5	Telephone Application Setup	33
Zones	6	User Setup	33
Zone Lockout	6	System Setup	34
Quick Set	6	Learn Remote Controls and Keypads	35
Event Log	6	Alarm Duration	36
Chime	6	Entry/Exit Delay Period	36
Monitoring	6	Entry Delay Beeps	37
Latch Key	7	Exit Delay Beeps	37
Remote System Control	7	Wireless Siren	37
Tamper Protection	7	Wired Siren	37
Jamming Detection	7	Auxiliary Relay	37
Battery Monitoring	7	Jamming Detection	37
PLANNING AND EXTENDING YOUR ALARM SYSTEM	8	Zone Lockout	38
Typical Installation	8	Time & Date Setup	38
REMOTE CONTROL UNIT	9	Dialler Operating Mode	38
General Information	9	Remote Phone Access and Control	38
Configuring the Remote Control	10	Rings to Answer Phone	38
Testing the Remote Control	10	Zone Setup	39
CONTROL PANEL	10	Learn Detector Code	40
Positioning the Control Panel	10	Monitoring Setup	42
Installing and Configuring the Control Panel	11	- Remote Manager	42
Linking a Remote Control or Remote Keypad to the Control Panel	12	- Voice Dialler	42
Testing the Control Panel and Remote Control	13	Latch Key Setup	45
PASSIVE INFRA-RED (PIR) MOVEMENT DETECTORS	14	Friedland Spectra Plus Lighting Setup	47
Positioning the PIR Detectors	14	OPERATING INSTRUCTIONS	48
Installing and Configuring the PIR Detectors	15	Voice Dialler	48
Testing a PIR Detector Independently	15	Arming the System	48
Linking a PIR Detector to the Control Panel	16	Part-Arming the System: Part-Arm 1	48
Testing a PIR Detector with the Control Panel	17	Part-Arming the System: Part-Arm 2	48
MAGNETIC DOOR/WINDOW DETECTORS	17	Disarming the System	48
Positioning the Door/Window Detectors	17	Disarming the System with the Duress Code	49
Installing and Configuring the Door/Window Detectors	18	Friedland Spectra Plus Lighting	49
Testing a Door/Window Detector Independently	19	Quick Set	49
Linking a Door/Window Detector to the Control Panel	19	Personal Attack (PA) Alarm	49
Testing a Door/Window Detector with the Control Panel	20	Latch Key	50
EXTERNAL SOLAR SIREN	21	Zone Lockout	50
General Information	21	Device Tamper	50
Positioning the Solar Siren	21	Chime	50
Installing and Configuring the Solar Siren	21	Keyboard Beep Mute	50
Power-up of the Solar Siren	22	Entry/Exit Beeps	50
Testing the Wireless Solar Siren	23	Event Log	50
Mounting the Solar Siren on to the wall	23	Remote Phone Access and Control	51
DUMMY SIREN	24	Monitoring	52
EXTERNAL CONNECTIONS	25	- Remote Manager	52
		- Voice Dialler	53
		Siren Service/Operating Mode	54
		Battery Monitoring	54
		MAINTENANCE	56
		ALARM RECORD	57
		TROUBLE SHOOTING	59
		EXTENDING YOUR ALARM SYSTEM	62
		COMPONENT SPECIFICATION	64

KIT CONTENTS

The Alarm System should contain the following devices.

- 1 x Solar Siren
- 1 x Dummy Siren
- 1 x Control Panel
- 2 x PIR Movement Detectors
- 2 x Magnetic Door/Window Detectors

Also included:

- Power Supply Adaptor
- RJ11-BT Telephone Connection Lead
- Siren and Dummy Siren Mounting Template
- Installation & Operating Manual
- Installation DVD
- Fixing Pack
- Batteries

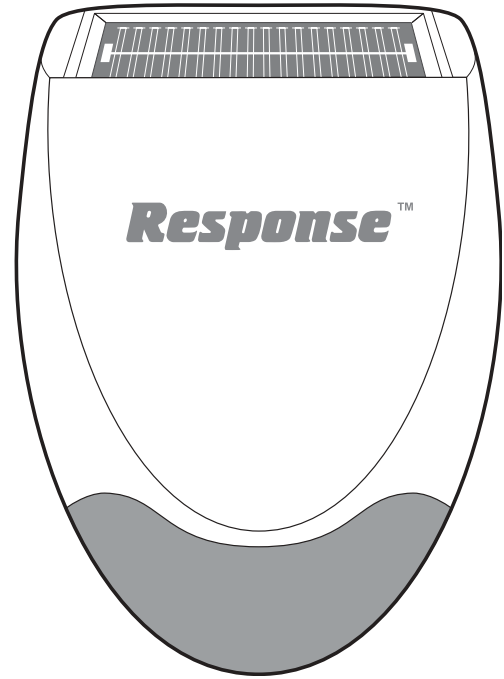

Solar Siren / Dummy Siren

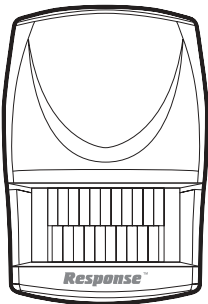

PIR Movement Detector

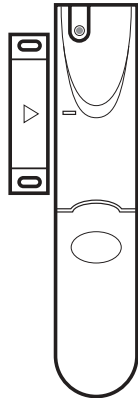

Door/Window Detector

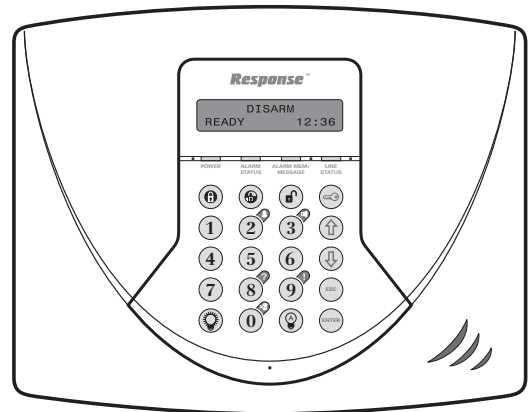

Control Panel

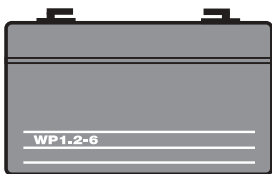

6V/1.2Ahr Sealed lead acid battery
(supplied 1 x fitted in Siren
and 2 x fitted in Control Panel)



9V PP3 Alkaline battery
(for Siren and
PIR Detectors)



1.5V C Alkaline
batteries (for
Dummy Siren)



3V CR2032 Lithium
Coin Cell (for Door/
Window Detectors)

HEALTH WARNING:
Do not put the coin cell battery in your mouth as this could impair your health. Keep this cell out of reach from young children as they could swallow it and choke.

PLEASE READ BEFORE YOU INSTALL

The Solar Siren is supplied complete with a rechargeable 6V battery. However, before installing this system, please ensure the battery is still fit for use by checking the date code label on it. Remove the battery cover on the rear of the Siren, you will see the label shown here. (Example of a date is **02/2009** meaning February 2009) **MM** = Month, **YYYY** = Year.

If the date you purchased this kit exceeds the install date but not the expiry date marked on this label, you will need to recharge the battery. You can use the Control Panel supplied with this kit to recharge this battery for 24 hours before you install the system. (See CONTROL PANEL section), but you will need to remove one of the supplied Control Panel batteries first.

If the battery has expired seek a replacement.

Install battery before **MM/YYYY** or else recharge after.

Battery expiry date **MM/YYYY**
(Do not recharge after expiry date).

INTRODUCTION AND OVERVIEW

MULTIPLE USERS

The system allows for up to 6 Users, a Master and a Duress User to be configured. This allows the system Event Log to maintain a record of which users have armed and disarmed the system. Each user will have a different User Access Code. In addition a 4 second voice recorder facility enables the user's name to be recorded for use with the Latch Key facility.

Only the Master User has access to the programming functions and is able to configure the system.

Note: Any Remote Control Units on the system will be recorded as User 6.

USER ACCESS CODE

The Control Panel is the brains of the system and is where the system is programmed and operated from. A 4 digit code is used to ensure that only authorised people have access to the system. This is the User access code and can be set to a code of your choice that only you and other authorised system users know.

SYSTEM ARMING

The system has a 'Full Arm' and two 'Part-Arm' modes. ARM will 'Arm' all zones while the 'Part-Arm' modes will only arm the zones that are enabled for the particular Part-Arm mode.

For example:

The system could be configured so that during night time, 'Part-Arm 1' would arm only zones protecting the lower floor and outbuildings leaving the upper floor free for movement without triggering the alarm.

During the day while the property is occupied 'Part-Arm 2' could arm only the zones protecting the outbuildings. However, when the property is left un-occupied, the 'Full Arm' mode will arm all zones to protect the entire property, (i.e. upper and lower floors and outbuildings).

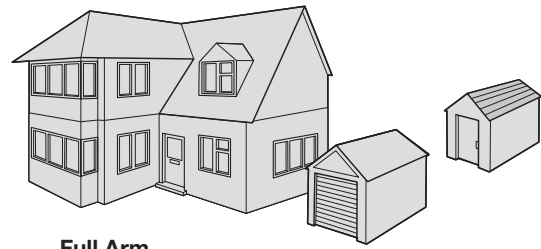

Full Arm

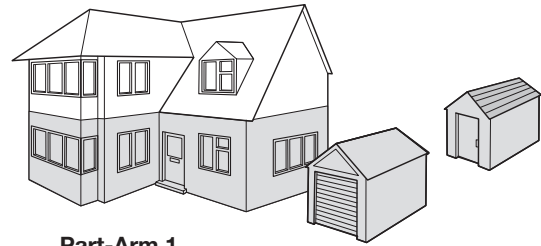

Part-Arm 1



Part-Arm 2

ENTRY/EXIT DELAY

When the system is armed with the Exit-Delay enabled, no signal from any detector on an active zone will be able to trigger an alarm until the Exit-Delay has expired. This enables the system to be armed from within the property and allows time for the user to exit the property without triggering an alarm. If the Exit-Delay is disabled then detectors on active zones will immediately be able to trigger an alarm once the system is armed.

The system Exit-Delay may be configured for between 10 to 250 seconds or disabled completely.

If a detector on a zone with its Entry-Delay enabled is triggered, then an alarm will not sound until the Entry-Delay period has expired. This allows time for the user to re-enter the property and disarm the system before an alarm occurs. Generally only the zones on the main entry route to the property will be configured with an Entry-Delay. The remaining zones would be configured with their Entry-Delay disabled allowing them to immediately initiate an alarm the instant a detector on the zone is triggered.

The Entry-Delay for each zone may be configured for between 10 to 250 seconds or disabled completely.

Note: To conserve power and maximise battery life the PIR Detector will only detect movement if there has been no movement detected within the previous 2 minutes. Consequently the PIR Detector will not become active until the protected area has been free from movement for more than 3 minutes.

ZONES

The system incorporates 32 wireless alarm zones for the connection of a detector per zone used to independently monitor different areas of the property. In addition to standard intruder protection, each zone can also be configured to operate in alternative modes.

For example:

- ‘Intruder’ mode provides standard intruder monitoring.
- ‘24-hour Intruder’ mode provides 24 hour intruder protection for areas where continuous monitoring is required, (e.g. gun lockers).
- ‘Fire’ mode provides 24 hour monitoring of any Smoke detectors incorporated into the system.
- ‘Test’ mode allows a zone to be monitored while the system is armed. If a detector on a zone is triggered an entry will be recorded in the Event Log but an alarm will not occur.

In addition there is the facility to connect up to 4 hard wired zones to the Control Panel, each of which is configurable with most of the features of the wireless zones.

ZONE LOCKOUT

If a detector on an active zone is triggered while the system is armed an alarm will sound. After the programmed alarm duration has expired the alarm will stop and the system will automatically reset. Subsequent detectors triggered will again trigger an alarm. If a single zone triggers an alarm more than 3 times then that zone will be ‘Locked Out’ and any further alarm signals from that zone will be ignored until the system is disarmed.

Note: The ‘Zone Lockout’ feature can be disabled if required.

QUICK SET

The system may be fully armed in 10 seconds using the quick set facility, overriding the programmed exit-delay. This is useful for setting the system at night when the Exit-Delay warning beep will be silenced after just a few seconds.

EVENT LOG

The Control Panel incorporates a memory capable of storing the last 99 system events. This enables the user to see which user has Armed/Disarmed the system and if and when any alarms occurred. The time, date and details of the event type will be recorded for each system event.

CHIME

Chime is a low security facility for use when the system is in Standby mode. If the Chime feature is ON, and a detector on a zone that has its Chime function enabled is triggered, the internal sounder will produce a low volume warning tone. A typical use of the Chime function would be to warn that a door or particular area has been entered.

MONITORING (OPTIONAL)

This system incorporates a telephone dialler (**Voice Dialler**) and monitoring service (**Remote Manager**). The monitoring service enables the system to make a check call to the premises and generate text/email/telephone calls/messages to up to 6 key holders. A monitoring service provider is required to make use of these features.

IMPORTANT: to set up monitoring follow **REMOTE MANAGER** instructions.

The system telephone dialler can be set up as a **Voice Dialler** that can be used to call for help and or/notify the user that the system has been triggered and an alarm has occurred.

In this mode the system will call for help using your recorded message and dial up to 4 telephone numbers and replay the corresponding alarm message for each number. Switching the system between **Remote Manager** to **Voice Dialler** is straightforward.

LATCH KEY

When the system is Disarmed the Latch Key facility, if enabled, will call the first Latch Key phone number and replay the user message (recorded under latch key setup) for the set 'Play Time'. The recipient must acknowledge the message by pressing the button on their telephone keypad. If the call is unanswered or an acknowledgment is not received then the second Latch Key phone number will be called. The Voice Dialler will continue calling each number in turn until each number has been dialled the set number of times or the sequence is cancelled/acknowledged by the recipient.

For example, the Latch Key facility is useful to inform parents that a child has returned from school and Disarmed the system.

REMOTE PHONE ACCESS AND CONTROL

It is possible to dial into the system via the connected telephone line to interrogate the system status and to have basic control over the system, (e.g. to Arm and Disarm the system). You may also activate the microphone on the Control Panel to Listen-In to what is happening in the protected property.

TAMPER PROTECTION

All system devices (except any Remote Control Units) incorporate Tamper protection features to protect against unauthorised attempts to interfere with the device.

Any attempt to remove the battery cover from any device (except a Remote Control) or to remove the Solar Siren or Control Panel from the wall will trigger the alarm even if the system is Disarmed (unless the system is in Test or Program modes).

JAMMING DETECTION

In order to detect any attempts to illegally jam the radio channel used by your alarm system, a special jamming detection function is incorporated into the Control Panel. If this feature is enabled, an alarm will be triggered if the radio channel is jammed continuously for more than 30 seconds or if the system is jammed for more than 3 periods of 10 seconds in a 5 minute period. At full alarm it will beep for 3 seconds and will alarm after 10 seconds, at Part Arm it will beep for 3 seconds.

The jamming detection circuit will constantly scan for jamming signals. However, it will also detect and could in extreme cases be triggered by radio signals from other radio equipment within range operating on the same frequency which would not interfere with the normal operation of your alarm.

If you are planning to operate the Jamming Detection feature we recommend that you wait at least 30 days before activating this feature to allow time for you to become familiar with the operation of your system.

When activating jamming detection the system should be monitored carefully for false jamming alarms for at least 2 weeks before leaving the Jamming Detection function permanently enabled.

BATTERY MONITORING

All devices powered by non-rechargeable batteries incorporate a battery level monitoring feature which will warn of a low battery status.

In addition the Control Panel will also indicate a low battery status on any PIR (Passive Infra-Red) or Magnetic Door/Window Detector on the system.

The batteries on any device indicating a low battery status should be replaced immediately.

PLANNING AND EXTENDING YOUR ALARM SYSTEM

Before attempting to install your Alarm System it is important to study your security requirements and plan your installation accordingly.

PIR Movement Detectors are used to protect the main areas of the property, (e.g. lounge, study, hallway and landing). Magnetic Door/Window Detectors are typically used to protect the main access points to the property, (e.g. front door, back door, patio doors etc). However, they can also be used to protect other vulnerable doors/ windows or access doors to important rooms.

TYPICAL INSTALLATION

The following example below shows a typical property incorporating the suggested positions for the External Siren, PIR and Magnetic Door/Window Detectors. Use this as a guide for your installation in conjunction with the detailed positioning requirements for each device provided in the appropriate installation sections in this manual for planning your intruder alarm system.

Typical Installation using only the detectors supplied:

1. Place the 1st Door/Window Detector (configured on zone 1) on the front door.
2. Place the 2nd Door/Window Detector (configured on zone 2) on the back or patio doors.
3. Place the 1st PIR Detector (set on zone 3) and the 2nd PIR Detector (set on zone 4) in two of the following locations:
 - i) downstairs in the main living room containing most valuables, or
 - ii) on the landing covering the access routes between bedrooms and the stairs, or
 - iii) in the hall covering the Control Panel and routes between downstairs rooms.

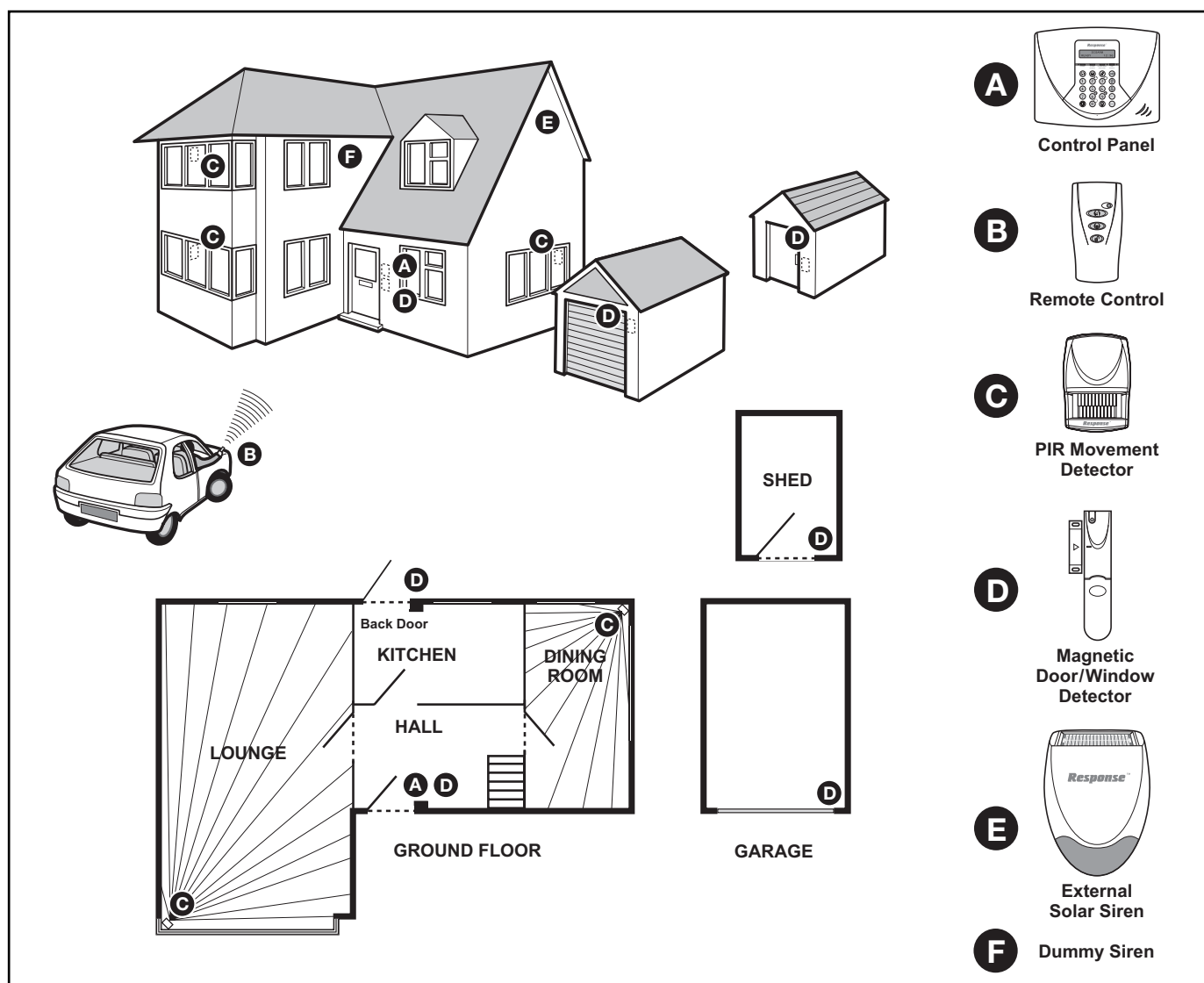

The system may be expanded with additional detectors, Remote Controls and Keypads to provide even greater protection. However, the following rules should be followed:

- a. Any detectors covering the main door and the route to the Control Panel should be set on zone 1 only.
- b. Any detectors covering the remainder of the lower floor should be set on zones 2 to 4 only.
- c. Any detectors placed upstairs (which are not required when activating Part-Arm1) should be set on zones 5 or 6 only.

The pre-configured system defaults provide a basic functional system, which will suit most installations, (i.e. a 2 floor house):

The systems factory settings are pre-configured to provide a basic functional system to suit most typical basic installations:

- Detectors on zones 1 and 2 will have a 30 second entry delay period. Detectors on all other zones are configured as INSTANT, (i.e. they have no entry delay).
- The system has a 3 minute alarm duration.
- The Zone Lockout feature is ON so that if any single zone triggers an alarm more than 3 times they will be ignored until the system is next disarmed, (this feature helps protect against continuous false alarms).
- PART-ARM 1 is configured with a 30 second exit delay and operates with detectors on zones 1 to 4 only.
- PART-ARM 2 is OFF.
- All other system features, (e.g. telephone dialler, Latch Key, Chime etc.) are OFF and not programmed.

IMPORTANT:

As soon as installation is complete

- The default Master User Access Code for the Control Panel should be changed to your own code that only you know.

- User Access Codes 1-6 for the Control Panel should be changed to your own codes that only the relevant system user knows.
- The system Time and Date must be configured.

Note: If you wish to change the system configuration away from the above example and factory settings and customise it to your own unique requirements or activate any of the more advanced system features then refer to the Programming section on page 32.

REMOTE CONTROL UNIT

The Remote Control Unit(s) is used to Arm in either Arm or Part-Arm and to Disarm the system.

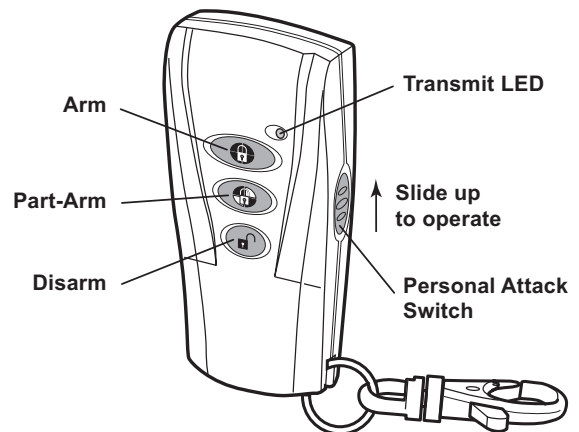

The Remote Control Unit also incorporates a Personal Attack (PA) switch. Activating the PA switch on the side of the Remote Control will immediately trigger an Alarm (unless the Control Panel is in Test or Program Modes) even if the system is disarmed. The alarm can be cancelled using the Remote Control by pressing the 'DISARM' button.

Up to a total of 6 Remote Controls and/or Keypad Units can be used with your system, providing they are all operated within effective radio range of the Control Panel.

The Remote Control is powered by a CR2032 type Lithium cell which under normal conditions will have an expected life of approximately 1 year. Under normal battery conditions the Transmit LED on the Remote Control will only illuminate when a button is pressed.

However, under low-battery conditions this LED will continue to flash after the button has been released. When this occurs the battery should be replaced as soon as possible.

CONFIGURING THE REMOTE CONTROL

1. Remove the rear cover by undoing the small screw on the rear of the Remote Control and keeping it safe for later.
2. Insert the battery under the clip ensuring that the + terminal faces upwards away from the Circuit Board.
3. Replace the rear cover and fixing screw. Do not over tighten the screw as this could damage the thread.

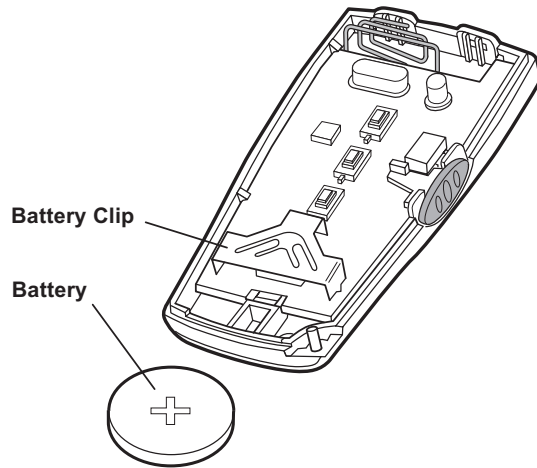

TESTING THE REMOTE CONTROL

4. Press the  button. The Transmit LED should illuminate while the button is pressed and extinguish within 1 second of releasing the button.
5. Pressing any button on the Remote Control will illuminate the Transmit LED as before to check that it is functioning correctly.

CONTROL PANEL

POSITIONING THE CONTROL PANEL

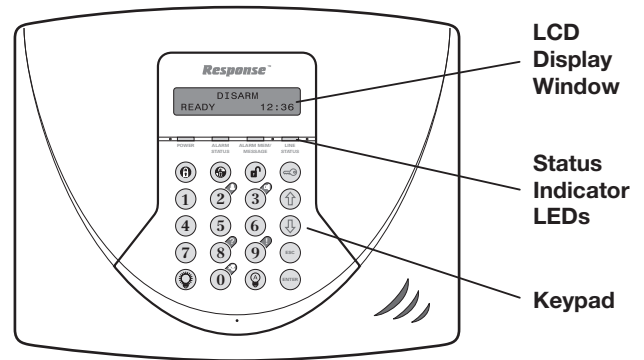

When choosing a suitable location for the Control Panel, the following points should be considered.

1. The Control Panel should be located in a position out of sight of potential intruders and in a safe location, but easily accessible for system operation and leaving and entering the house within the set time period.
2. The Control Panel should be mounted on a sound flat surface to ensure that the rear tamper switch on the Control Panel is closed when the Panel is mounted. The Control Panel should be mounted at a convenient height of between 1.5 and 2 metres and in a position where it will be seen each day.
Note: If small children are in the household, a further consideration should be given to keeping the unit out of their reach.
3. It is recommended that the Control Panel should be positioned such that the Exit/Entry tone (emitted by the Control Panel) can be heard from outside the property.
4. The Control Panel should be mounted within a protected area so that any intruder cannot reach the Control Panel without opening a protected door or passing through an area protected by a PIR Detector when the system is armed.
5. **The Control Panel must be located within reach of a mains socket.**
6. If any of the telephone based functions are to be used then the Control Panel will need connecting to a convenient telephone point.

Note: It is recommended that the telephone connection lead is not extended beyond 10 metres before connecting to a telephone master or secondary outlet.

- DO NOT fix the Control Panel onto or very close to metalwork (i.e. radiators, water pipes, etc) as this could affect the radio range of the device.**

Do not drill the fixing holes with the Control Panel in position; as the resulting dust and vibration may damage the Control Panel's internal components and invalidate the guarantee.

INSTALLING THE CONTROL PANEL

- Undo the two cover fixing screws on top of the panel and open the cover. The cover is hinged along the bottom edge.
- Unclip and remove the two back-up batteries on either side of the panel.
- Hold the Control Panel in position on the wall and mark the positions of the four fixing holes. Remove the panel, drill four 5mm holes and fit the 22mm wall plugs.

Note: The wall plugs supplied with the product are not suitable for plasterboard walls. If mounting the Control Panel onto plasterboard use appropriate wall plugs.

- Fit two 18mm No.4 screws into the top holes until 3mm protrudes from the wall face and hang the Control Panel over these screws using the two keyhole slots in the top corners of the panel casing.
- Route the cable from the Power Supply Adaptor up behind and on the right hand side of the Control Panel and connect the plug to the DC power socket in the panel. Ensuring that the cable is not trapped between the panel and the wall.
- Fix the Control Panel to the wall using two 18mm No.4 screws in the lower two fixing holes in the Control Panel and tighten the upper fixing screws until they just grip the casing. Do not over-tighten the screws as this could damage or distort the casing.

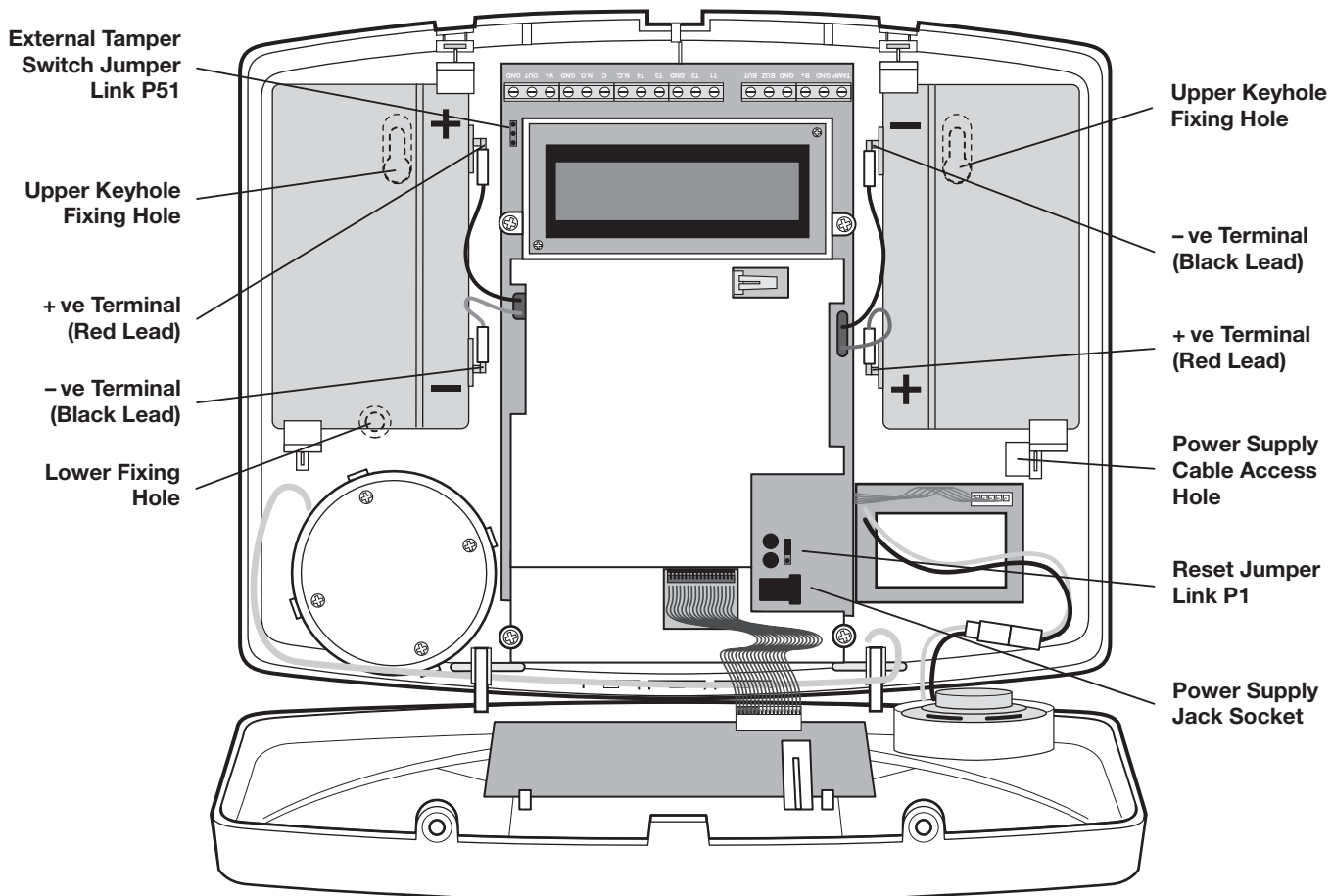

Inside View of Control Panel

- Ensure that the Reset Jumper Link (P1) and the External Tamper Switch Jumper Link (P51) are set in the OFF position.

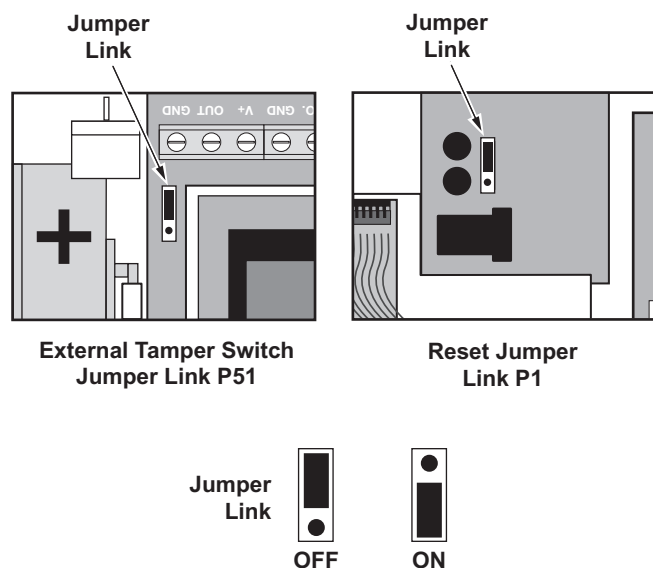

- Connect battery leads to both back-up batteries and refit batteries.

LEFT Battery: Red lead to the Red (+) battery terminal
Black lead to the Black (-) battery terminal



RIGHT Battery: Red lead to the Red (+) battery terminal
Black lead to the Black (-) battery terminal

IMPORTANT: Take care when connecting battery leads to the batteries as connecting incorrectly could damage the batteries or the Control Panel.

Note: The Power LED may flash to indicate that the unit is being operated from the back-up batteries and that mains supply is not present.

- If fitted, remove the plastic film covering the LCD display and on the display window on the cover.
- Close the lid of the Control Panel and fasten the cover fixing screws.
- Plug in and switch ON the Power Supply Adaptor, (the Power LED should illuminate).
- If required, connect the Control Panel to the telephone line using the cable supplied by

inserting the small RJ11 plug into socket marked LINE located on the bottom edge of the Control Panel. If the cable supplied is not long enough to reach a suitable phone point then it will need extending using a coupler and extension lead (not supplied).

Note: If the Control Panel Tamper alarm sounds during the installation reset the alarm by pressing , **1** **2** **3** **4**,  on the Control Panel.

User Access Code

IMPORTANT: The keys must be pressed firmly and within 5 seconds of each other. If you make a mistake, press  and start the sequence again.

LINKING A REMOTE CONTROL OR REMOTE KEYPAD TO THE CONTROL PANEL





If there are already 6 Remote Controls/Keypads linked to the Control Panel then it will not be possible to link any more. Attempting to learn a 7th device will cause the panel to produce a single long beep and display 'Cannot Learn - System Full' message on screen for 3 seconds.

With unit in Standby mode (Power LED only illuminated).

- Press , **1** **2** **3** **4**, 
- Master User Access Code*

This puts the Control Panel into Programming Mode.

'1. USER SETUP' will be displayed.

- Use the  and  buttons to scroll through the menu until '2. SYSTEM SETUP' is displayed and press . '2-1 Remotes' will be displayed.
- Press  again.

The number of Remote Controls/Keypads already linked will be shown, (e.g. if there are two Remotes Controls and one Remote Keypad linked the display will show '2.1 Remotes = 3').

The new Remote Control/Keypad can be programmed as follows:

- Press **3**.

The panel will now listen for a valid signal from a new Remote Control or Keypad.

The Panel will remain in Learn Mode for 30s. If a valid signal is not received from a new device within 30s it will automatically exit Learn Mode and return to the top of level 2.0.

5. Press  on the Remote Control, or

Press     ,  on
Keypad User Access Code

the Remote Keypad.

Note: *If the device is already linked to the control panel then the panel will produce a single long beep and the received signal from the device will be ignored.*

If the device is new and not already linked to the system the control panel will produce two short beeps and the display will show 'New Device' and the type or the detected device; (e.g. Remote or Keypad).

6. Confirm the new device ID code from the same new Remote Control or Remote Keypad within 15s as follows:

Press  on the Remote Control, or

Press     ,  on
Keypad User Access Code

the Remote Keypad.







Note: *If the confirmation signal is not received within 15s the control panel will produce a single long beep and exit the learning process. The learning process will need to started again to learn the new device into memory.*

The panel will produce three short beeps and the LCD will show 'Device Confirmed'.

The LCD will then show 'Saving New Device' while the ID code of the new detector is stored into memory.

7. Press  twice to return to standby.

TESTING THE CONTROL PANEL AND REMOTE CONTROL

1. Press  ,     ,  to put the system into Test Mode.

Use the  and  buttons to scroll through the menu until 'Detector Walk Test' is displayed.

2. Press  to activate Walk Test.

During the test the LCD will display:

Walktest
Waiting...

3. Press the Arm, Part Arm, Disarm and Personal Attack buttons in turn on the Remote Control.

Note: If no signal is received by the Control Panel within 10 minutes, the display will return to 'Detector Walk Test'.

When signals are received from linked Remote Control, the appropriate messages will be displayed on the LCD screen:

Remote Control - ARM

Remote/Keypad
Arm

Remote Control/Keypad - DISARM

Remote/Keypad
Disarm

Remote Control - PANIC/PA

Remote/Keypad
Panic/PA

4. Press  to return to the top level menu of TEST MODE.

PASSIVE INFRA-RED (PIR) MOVEMENT DETECTORS

PIR Detectors detect movement in a protected area by detecting changes in infra-red radiation levels caused for example when a person moves within or across the PIR's detection pattern. If movement is detected an alarm will be triggered, (if the system is armed). PIR Detectors will also detect animals, so ensure that pets are not permitted access to areas fitted with PIR Movement Detectors when the system is armed.

The Detector incorporates an anti-tamper protection feature to protect against attempts to interfere with the device. If the battery cover is removed, an alarm will immediately occur at any time, (unless the system is in Program or Test Modes).

The PIR Detector also incorporates a sensitivity adjustment feature to compensate for situations where the detector may be triggered by environmental changes, (e.g. insects, air temperature, etc).

To conserve power and maximise battery life the PIR Detector will only detect movement if there has been no movement detected within the previous 2 minutes, (this is known as the detectors sleep period).

The PIR Detector is powered by a PP3 Alkaline battery which under normal conditions will have an expected life of approximately 1 year. When the battery level drops, with the PIR in normal operation mode and the battery cover fitted, the LED behind the detection window will flash. When this occurs the battery should be replaced as soon as possible. (**Note:** in normal operation, the LED behind the lens will not flash on detection of movement).

The system allows you to link one Detector to a zone, provided that the Detector is mounted within effective radio range of the Control Panel.

POSITIONING THE PIR DETECTORS

The recommended position for a PIR Detector is in the corner of a room mounted at a height between 2 and 2.5 metres. At this height, the detector will have a maximum range of up to 12 metres with a field of view of 110°.

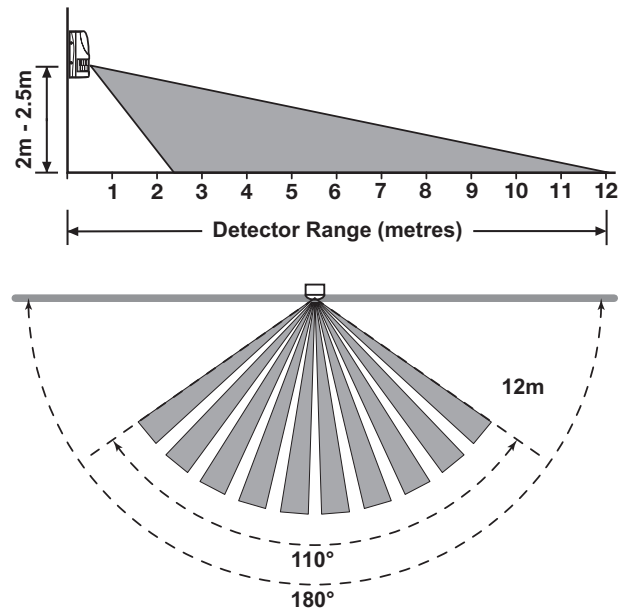

When deciding upon the mounting position for the detector the following points should be considered to ensure trouble free operation:

1. Do not position the Detector facing a window or where it is exposed to or facing direct sunlight. PIR Detectors are not suitable for use in conservatories.
2. Do not position the Detector where it is exposed to draughts.
3. **Do not position the Detector directly above a heat source, (e.g. fire, radiator, boiler, etc).**
4. Where possible, mount the Detector in the corner of the room so that the logical path of an intruder would cut across the fan detection pattern. PIR Detectors respond more effectively to movement across the device than to movement directly towards it.
5. Do not position the Detector in a position where it is subject to excessive vibration.
6. Ensure that the position selected for the PIR Detector is within effective range of the Control Panel.
7. **Do not fix the PIR Detector onto or very close to metalwork (i.e. radiators, water pipes, etc) as this could affect the radio range of the device.**

Note: When the system is Armed, pets should not be allowed into an area protected by a PIR Detector as their movement could be detected and trigger an alarm.

INSTALLING AND CONFIGURING THE PIR DETECTORS

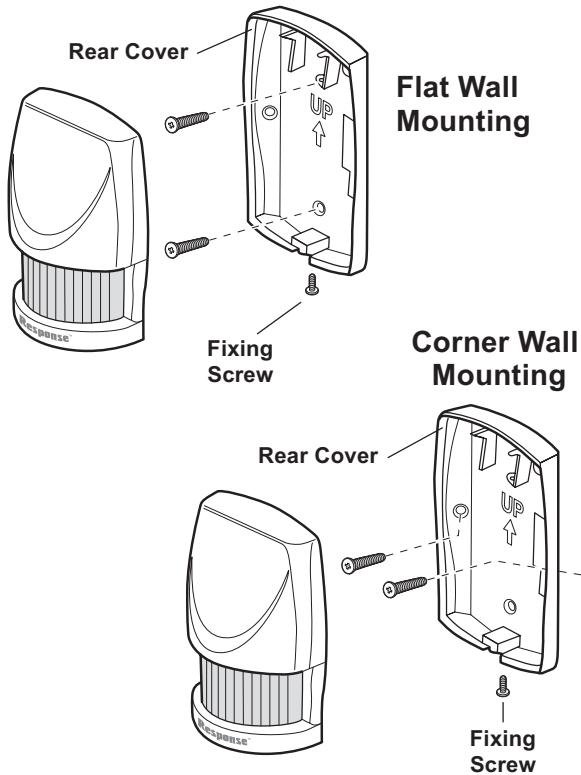

1. Undo and remove the fixing screw from the bottom edge of the PIR Detector, (keep the screw safe for later). Carefully pull the bottom edge of the detector away from the rear cover and then slide down to release the top clips.
2. Carefully drill out the required mounting holes in the rear cover using a 3mm drill according to whether the unit is being mounted in a corner or against a flat wall.
3. Using the rear cover as a template, mark the positions of the fixing holes on the wall.

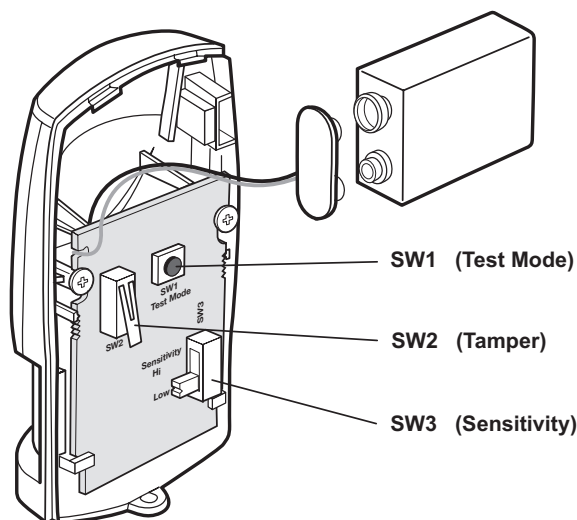

4. Fix the rear cover to the wall using the two 18mm No.4 screws and 22mm wall plugs, (a 5mm hole will be required for the wall plugs). Do not over-tighten the screws as this may distort or damage the cover.

Note: The wall plugs supplied with the product are not suitable for plasterboard walls, if mounting the Detector onto plasterboard use appropriate wall plugs.

5. To select the required sensitivity, set switch SW3 as follows:

UP HIGH sensitivity

DOWN LOW sensitivity

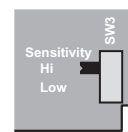

SW3 up
High Sensitivity

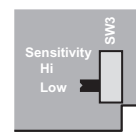

SW3 down
Low Sensitivity

Note: The recommended setting is HIGH. However, in cases of extreme environmental problems or if unexplained false alarms are experienced, it may be necessary to set the sensitivity to LOW. Setting the device to LOW sensitivity will require a greater amount of movement in order to trigger the device.

6. Connect the PP3 Alkaline battery to the battery clip. The LED behind the lens will rapidly flash for approximately 2-3 minutes until the PIR has stabilised. The LED will then stop flashing and turn OFF.

TESTING A PIR DETECTOR INDEPENDENTLY





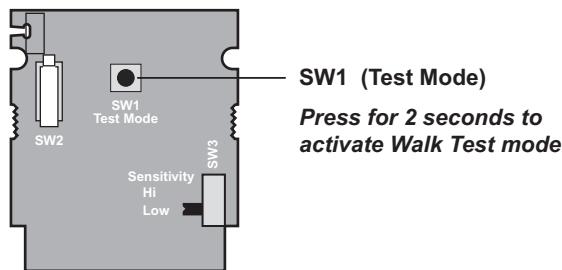



7. Ensure that the LED indicator has stopped flashing rapidly.
8. The 'Test Mode' button (SW1) is used to put the PIR Detector into Walk Test Mode, which overrides the 2 minute sleep period and allows the operation of the detector to be checked during installation. Press and hold the button for 2 seconds to activate Test Mode for a fixed 5 minute after which it will automatically revert to normal operation.

On initial installation the detector should be configured into Walk Test ready for testing, (i.e. Pressing down SW1 for 2 seconds).





9. Refit the PIR Detector to the rear cover by offering the detector up to the rear cover and locate the clips in the top edge into the rear cover. Push the lower edge of the detector into place and refit the fixing screw in the bottom edge of the PIR to secure in position. Do not over-tighten the screws as this may damage the casing.
10. Walk into and move slowly around the protected area within the 5 minutes of pressing SW1. Each time the detector senses movement the LED indicator behind the lens will flash.

LINKING A PIR DETECTOR TO THE CONTROL PANEL

1. Remove the PIR Detector from its rear cover after installing and configuring it.
2. With the system in Standby
Press  ,     , 
Installer Access Code
to enter Program Mode.
3. Scroll through the programming menu until '3. ZONE SETUP' is displayed and press  .
4. Enter the zone number to be configured (1 - 36) and press  .

'3-1 ZX Empty' will be displayed (X = Zone no.)

Note: Zones 33 - 36 the wired zones are the same except there is no learn menu option as these are wired.
5. Press  .

6. To learn a new detector ID code and link it to the selected zone press  .

The panel will now listen for a valid signal from a new detector to link to the zone.

The Panel will remain in Learn Mode for 30s. If a valid signal is not received from a new device within 30s it will automatically exit Learn Mode and return to the top of level 2.0.

7. Activate the Tamper Switch on the PIR detector.

Note: *If the detector is already linked to the control panel on any other zone then the panel will produce a single long beep and the received signal from the detector will be ignored.*

If the detector is new and not already linked on any security zone the panel will produce two short beeps and the display will show 'New Device' and the type of device detected (PIR).

8. Confirm the new device ID code by activating the Tamper Switch on the same new PIR detector within 15 seconds.

Note: *If the confirmation signal is not received within 15s the control panel will produce a single long beep and exit the learning process. The learning process will need to be started again to learn the new device into memory.*



The panel will produce three short beeps and the LCD will show 'Device Confirmed'.

The LCD will then show 'Saving New Device' while the ID code of the new detector is stored into memory.

9. Refit the PIR to its rear cover.
10. After completing the Zone Setup press  to return to the top level of programming menu.

Note: Ensure that there is no movement in front of the PIR for 3 minutes to allow it to stabilise before entering test mode.

TESTING A PIR DETECTOR WITH THE CONTROL PANEL

1. Ensure that the system is in Test Mode (see page 13).
2. Use the  and  buttons to scroll through the menu until 'Detector Walk Test' is displayed and press .

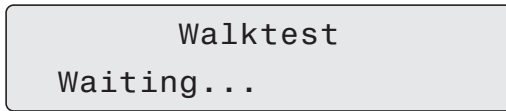

will be displayed.

Note: If no signal is received by the Control Panel within 10 minutes, the display will return to 'Detector Walk Test'.

3. Walk into and move slowly around the protected area, each time the detector senses movement the LED indicator behind the lens will flash.

In addition, the Control Panel will beep to indicate that the alarm signal has been received and the identity of the zone that the detector is configured for will be displayed.

4. Remove the back cover of the PIR detector. The Control Panel should beep and display:

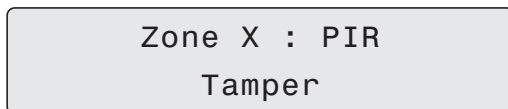

to show that the detector's tamper switch has been activated.

5. Refit the cover to the PIR Detector.
6. Press  to exit Test Mode and return to standby.

IMPORTANT: In normal operation, the LED indicator behind the detector lens will not flash on movement detection, (unless the battery is low).

When the detector is fully installed i.e. battery cover fitted and in operating mode; in order to conserve power and maximise battery life the PIR Detector will only detect movement if there has been no movement detected within the previous 2 minutes.

MAGNETIC DOOR/WINDOW DETECTORS

The Magnetic Door/Window Detector comprises of two parts; a Detector and a Magnet. They are designed to be fitted to either doors or windows with the Magnet mounted on the opening part of the door/window and the Detector mounted to the frame.

When the protected door or window is opened and the Magnet is moved away from the Detector an alarm will be triggered if the system is armed,

The Magnetic Door/Window Detector has the facility to connect an additional wired Magnetic Contact. This must be of a normally closed contact type with the contact being opened in order to generate an alarm condition.

The Magnetic Door/Window Detector is powered by two CR2032 type Lithium cells which under normal conditions will have an expected life of approximately 1 year. Under normal battery conditions the LED on the Detector will not illuminate when the Detector is triggered, (unless the detector is in Test Mode with the battery cover removed). However, under low battery conditions this LED will be illuminated for approximately 1 second when the detector is triggered. When this occurs the batteries should be replaced as soon as possible.

The system allows you to link one Detector to a zone, provided that the Detector mounted within effective radio range of the Control Panel.

POSITIONING THE MAGNETIC DOOR/WINDOW DETECTORS

The Door/Window Detector is suitable for mounting in dry interior locations only.

Decide which doors and windows are to be protected by fitting Door/Window Detectors, (usually the front and back doors as a minimum will have Door/Window Detectors fitted). However additional detectors may be fitted where required to other more vulnerable doors or windows, (e.g. garage, patio/conservatory doors etc).

Ensure that the position selected for the Door/Window Detector is within effective range of the Control Panel.

Do not fix the Detector onto or very close to metalwork (i.e. radiators, water pipes, etc) as this could affect the radio range of the device.

On PVC door/window frames, it may be necessary to space the Detector and Magnet away from the metal surface using a plastic or wooden spacer to achieve the necessary radio range.

INSTALLING AND CONFIGURING THE MAGNETIC DOOR/WINDOW DETECTORS

The Detector and Magnet should be mounted together along the opening edge of the window/door opposite the hinges. Ensure that the parallel gap between the Magnet and Detector is less than 10mm and that the arrow on the magnet is aligned with the mark on the detector.

1. Remove the battery cover by sliding and lifting it off. (DO NOT use a screwdriver to lever it off).

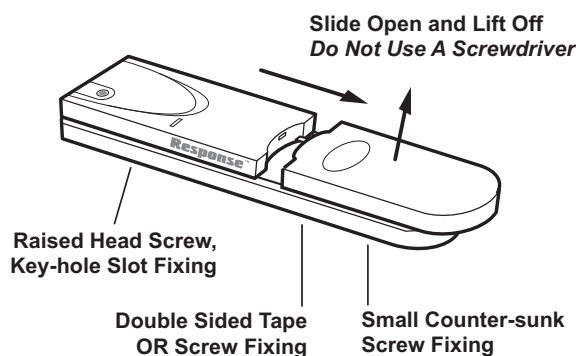

2. Slide the **two** batteries supplied into the battery holder, ensuring that the + side is uppermost on each battery as it is installed.

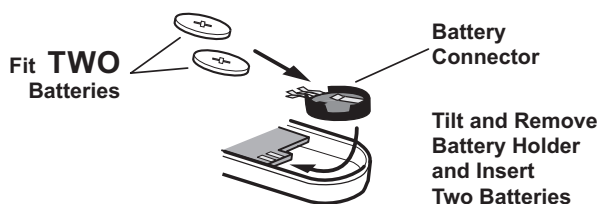

3. If necessary, refit the battery holder into the detector ensuring that the spring clip connectors slide onto either side of the circuit board.

The Detector should be mounted on the fixed part of the frame and the magnet on the opening part.

The Detector and Magnet should be mounted using the double sided adhesive pads or screws provided.

Note: If mounting the device using the adhesive pads, ensure that the mounting surfaces are clean and dry before mounting.

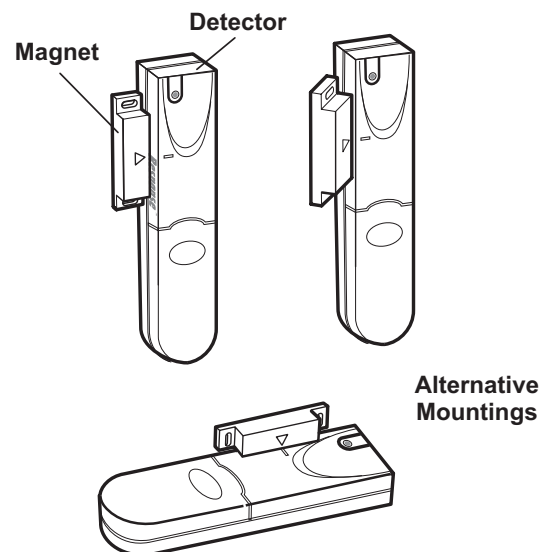

4. If fixing the detector with screws first remove the battery holder by carefully tilting up the end and pulling away from the printed circuit board (PCB).

The top of the Detector is secured by hanging the keyhole slot over the head of the 10mm pan head screw. The bottom of the Detector is secured using the 12mm counter-sunk head screw fitted within the battery compartment. Carefully drill out the centre of the fixing screw hole in the battery compartment using a 3mm drill. Fit the Magnet using the two 15mm fixing screws. Do not over-tighten the screws as this may distort or damage the casing.

5. If an additional wired Magnetic Contact is required, this should be wired to the terminal block provided in the battery compartment.

The wired contact should be connected using a maximum length of 1.5 metres of any of the following:

- 6 core alarm cable
- 2 core bell wire (6 x 0.2mm minimum)
- 2 core 24AWG wire

A cable entry cut-out is provided beside the terminal block in the battery cover.

- Switch SW3 is used to enable/disable the internal/external wired magnetic contact.

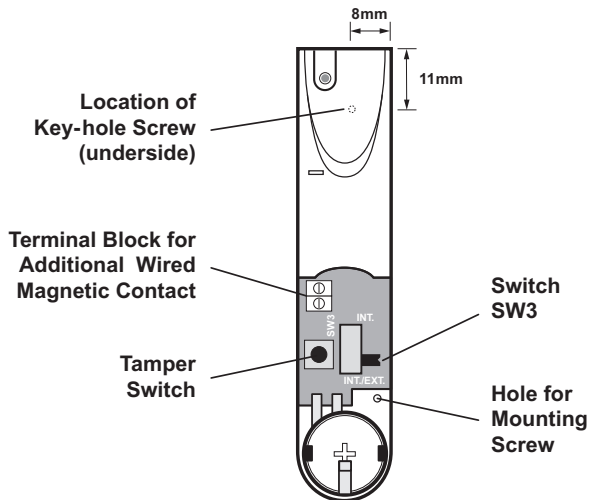

Position of SW3	Function
INT.	Internal Contact ON
INT./EXT.	Internal and External Contacts ON

- Set the Door/Window Detector by setting the position of the switch (SW3).

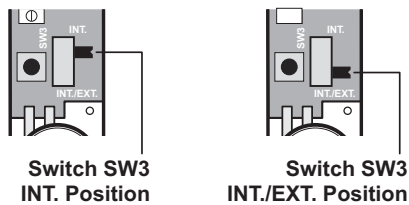

If setting to the INT. position, only the internal contact will be active. When two contacts are in use for internal and external connection simultaneously (INT./EXT. position), only one activation will be counted if one of the contacts is opened. If one contact is left open and the other closed contact is opened then an activation will be counted.

If using external contacts wired to the Detector, set to the INT./EXT. position.

IMPORTANT: If not using external contacts, set to the INT. position for the Detector to operate correctly.

- Refit the battery cover.

TESTING A MAGNETIC DOOR/WINDOW DETECTOR INDEPENDENTLY

- Remove battery cover to activate the tamper switch.

As the button is released the LED indicator will illuminate for approximately 1 second to show that the tamper switch has been triggered and a signal is being transmitted.

- Open the door/window to remove the Magnet from the Detector.

As the Magnet is moved away from the Detector the LED indicator will illuminate for approximately 1 second to show that the Detector has been triggered and a signal is being transmitted.

Note: It does not matter if the LED indicator illuminates as the magnet is brought towards the detector.

LINKING A MAGNETIC DOOR/WINDOW DETECTOR TO THE CONTROL PANEL

- Remove the battery cover after installing and configuring it.

- With the system in Standby

Press , ,
 Installer Access Code

to enter Program Mode.

- Scroll through the programming menu until '3. ZONE SETUP' is displayed and press .
- Enter the zone number to be configured (1 - 36) and press .

Note: Zones 33 - 36 the wired zones are the same except there is no learn menu option as these are wired.

- To learn a new detector ID code and link it to the selected zone press .

The panel will now listen for a valid signal from a new detector to link to the zone.

The Panel will remain in Learn Mode for 30s. If a valid signal is not received from a new detector within 30s it will automatically exit Learn Mode and return to the top of level 3.1

6. Activate the Tamper Switch on the MAG detector.

Note: If the detector is already linked to the control panel on any other zone then the panel will produce a single long beep and the received signal from the detector will be ignored.

If the detector is new and not already linked on any security zone the panel will produce two short beeps and the display will show 'New Device' and the type of device detected (MAG).

7. Confirm the new device ID code by activating the Tamper Switch on the same new MAG detector within 15 seconds.



Note: If the confirmation signal is not received within 15s the control panel will produce a single long beep and exit the learning process. The learning process will need to be started again to learn the new device into memory.

The panel will produce three short beeps and the LCD will show 'Device Confirmed'.

The LCD will then show 'Saving New Device' while the ID code of the new detector is stored into memory.

8. Refit the battery cover.
9. After completing the Zone Setup press  to return to the top level of programming menu.

TESTING A MAGNETIC DOOR/WINDOW DETECTOR WITH THE CONTROL PANEL

1. Ensure that the system is in Test Mode (see page 13).
2. Use the  and  buttons to scroll through the menu until 'Detector Walk Test' is displayed and press .

Walktest
Waiting...

will be displayed.

Note: If no signal is received by the Control Panel within 10 minutes, the display will return to 'Detector Walk Test'.

3. Open the door/window to remove the Magnet from the Detector.

In addition, the Control Panel will beep to indicate that the alarm signal has been received and the identity of the zone that the detector is configured for will be displayed.

4. Remove the battery cover. The Control Panel should beep and display:

Zone X : MAG
Tamper

to show that the detector's tamper switch has been activated.

5. Refit the battery cover.
6. Press  to exit Test Mode and return to standby.

IMPORTANT: With the battery cover fitted the LED indicator will not flash when the door / window is opened, (unless the battery is low).

EXTERNAL SOLAR SIREN

The Siren is encapsulated within a tough polycarbonate housing that also provides full protection against adverse weather conditions.

An LED indicator unit is built into the Siren to act as a visible deterrent and indication that the system is active. The LEDs will slowly and alternately flash whether the system is Armed or Disarmed. When an alarm occurs the LEDs will flash rapidly together.

An integral tamper switch provides additional security protection to the Siren and will immediately trigger an alarm should any unauthorised attempt be made to interfere with and remove the Siren cover.

The Siren is powered by a rechargeable sealed lead acid battery. A solar panel mounted on the top of the housing charges the battery during daylight hours. During darkness, only a small amount of energy is required to operate the Siren unit. A 9V Alkaline PP3 battery is supplied to boost the initial power to the unit when the system is first activated until the solar panel charges the main battery. (This battery is only designed to last for a short period until the main rechargeable battery has obtained sufficient charge). It does not need to be replaced.

POSITIONING THE SOLAR SIREN

The Siren should be located as high as possible in a prominent position on an external wall so that it can be easily seen and heard. The Siren should be mounted on a sound flat surface so that the rear tamper switch is not activated when mounted.

Ensure that the tamper switch does not fall into the recess between brick courses as this could prevent the switch from closing and give a permanent tamper signal.

In order to provide the maximum amount of daylight to the solar panel, the Siren should ideally be mounted on a south facing wall. However, an easterly or westerly position will suffice, but mounting the device on a north facing wall should be avoided due to the short dark days of winter months.

Shadows cast by neighbouring walls, trees and roof overhangs should also be avoided. If the Siren is to be mounted below the eaves, it should be positioned a distance of at least twice the depth of the eaves overhang below the eaves. Remember that in winter the sun is lower in the sky and you should avoid winter shadows where possible.

The Solar Siren contains a sophisticated radio receiver. However, reception of radio signals can be affected by the presence of metallic objects within the vicinity of the Siren. It is therefore important to mount the Siren a minimum distance of 1 metre away from any external or internal metalwork, (i.e. drainpipes, gutters, radiators, mirrors etc). Be especially aware of radiators mounted on the inside wall behind possible locations for the Siren.

Ensure that the position selected for the Siren is within effective range of the Keypad and all detectors.

INSTALLING AND CONFIGURING THE SOLAR SIREN

Ensure that the system is in Test Mode.

Press  ,     , 
User Access Code

to put the system into Test Mode.

1. Working on a table, undo the two battery cover fixing screws and remove the battery cover.
2. Under the cover you will also find a row of 5 DIP Switches labelled SW3 and a “LEARN” button.
3. Ensure that DIP switch 5 of SW3 on the main board is set to **OFF** (“SIREN”) for use with this alarm system.

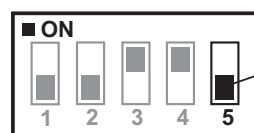

Switch SW3

C.U. OR SIREN
Set to 'OFF'

4. DIP switch 1 marked “**ALARM TIME**” is used to limit the maximum period for which the external siren will sound before it will be automatically shut down, (even if the Control Panel is still in alarm):
ON 10 minutes
OFF 3 minutes

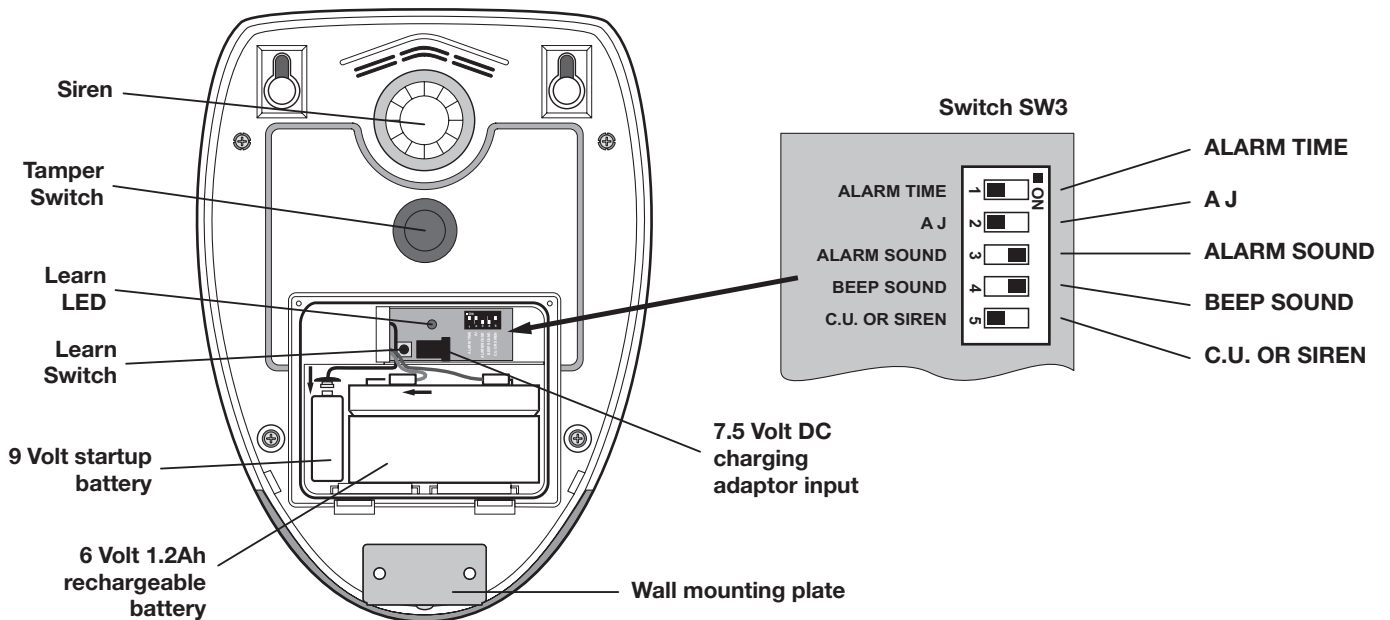

5. DIP switch 2 marked “AJ” does not function for this system and should be ignored.
6. DIP switch 3 marked “ALARM SOUND” if OFF will prevent the siren from sounding during an alarm, (this will not affect the warning beeps):

ON	Siren enabled
OFF	Siren disabled
7. Switching between Service Mode and Operating Mode generates a series of beeps. It is possible to disable these acknowledgement beeps with DIP switch 4 marked “BEEP SOUND”.

ON	Beeps enabled
OFF	Beeps disabled
8. Now see Power-Up of the Solar Siren.

POWER-UP OF THE SOLAR SIREN

Note: The use of ear defenders is advisable when working in close proximity to the Siren due to the high sound level produced by this device when triggered. Whenever the Siren is powered-up, it will automatically power-up in Service Mode. It cannot be switched out of Service Mode and into Operating Mode until the Control Panel is linked to it.

9. Connect the rechargeable battery to the battery leads. Connect the Red lead to the Red (+ve) terminal and the Black lead to the Black (-ve) terminal.
Connect the 9V 6LR61 (PP3) power-up battery to the battery clip.

10. Press the tamper switch, both indicator LEDs will flash together several times. The LEDs will then continue to flash alternately every 5 seconds thereafter to indicate that the Siren is functioning (still in Service Mode).
11. If fitted remove the protective film covering the Solar Panel.
12. Press and hold the Learn button inside the Sirens battery compartment for 5 seconds until the Siren enters Learn Mode and produces a single short low volume beep and both Learn and Indicator-LEDs start flashing together slowly (once every 2 seconds).

The siren will remain in Learn Mode for 30s. If a valid signal is not received from a Control Panel within that period it will automatically exit Learn Mode. It will remain in Service mode.

13. Use the and buttons to scroll through the menu until ‘Link Panel to Wirefree Siren’ is displayed.
14. Press .

The LCD will display ‘Sending ID Codes wait 15s...’ for 15s.

After 2 seconds the ‘Siren Stop’ signal will be transmitted by the panel to the siren to learn the panel’s code.

The siren will produce a single short beep and

the Indicator/Learn LEDs will start flashing together rapidly, (once every second).

After 10s the 'Siren Stop' signal will automatically be retransmitted by the Control Panel for the siren to confirm the control panels ID code.

The siren will produce single long beep and the Indicator/Learn LEDs will stop flashing and remain ON for 3 seconds after which it will go out to indicate that the Control Panel is now linked to the Siren and its ID code recorded in memory.



15. Now scroll through the menu again until 'Wirefree Siren Service OFF' is displayed and press .

The Siren will produce a single long beep followed by two short beeps.

16. Do not exit Test Mode at this stage. Now test the Wireless Siren prior to installing it on the wall. (See step 17 below).

TESTING THE WIRELESS SOLAR SIREN

Enter Test Mode if not already in (see page 13).

17. Use the  and  buttons to scroll through the menu until 'Wirefree Siren Test' is displayed and press .



During the test the LCD will display:

Siren ON for 5s
Stop->ESC



18. The Siren will activate for 5 seconds to show it is working. Now follow the instructions below to mount the Solar Siren on to the wall.

MOUNTING THE SOLAR SIREN ON TO THE WALL

Prior to mounting the Siren, the Siren needs to be placed into Service mode again else pressing the Siren's Tamper Switch against the wall will trigger the Siren.

19. Scroll through the Test Mode menu using the  and  buttons until 'Wirefree Siren Service ON' is displayed and press .

The Siren will produce two short beeps followed by one long beep.

20. Hold the clear plastic mounting template supplied in position on the wall and mark the positions of the four mounting holes. A spirit level placed on the top edge will help ensure you get the unit level.
21. Undo the fixing screw securing the mounting plate from the bottom edge of the siren and remove the plate.
22. Drill four 6mm holes and fit the wall plugs.
23. Fit the two 30mm fixing screws in the top holes leaving approximately 9mm of the screw protruding.
24. Fit the keyhole slots in the top of the siren over these screws and check that they form a neat fit with minimal movement. If necessary remove the siren and adjust the screws as required.
25. Remove the siren and fit the wall mounting plate in position using the two 25mm fixing screws.
26. Fit the siren to the wall ensuring that the keyhole slots are correctly fitted over the heads of the two top fixing screws and the lower fixing hole lines up with the wall plate.
27. Secure the Siren in place by fitting the lower fixing screw in the wall plate. Do not over-tighten the screw as this could damage the thread.
28. Now switch the Siren out of service mode. In the Test Menu, select 'Wirefree Service OFF' again and press .
- The Siren will produce a single long beep followed by two short beeps.
29. Press  to exit Test Mode and return the system to Operating Mode.

IMPORTANT:

The Siren must now be left in position for at least 24 hours to fully charge the Main Battery before testing or operating the alarm.

DUMMY SIREN

INSTALLATION

1. Remove the two screws on the battery compartment cover on the rear of the Dummy Siren and remove the cover.
2. Insert the 4 batteries ensuring correct polarity
3. Refit the battery cover.

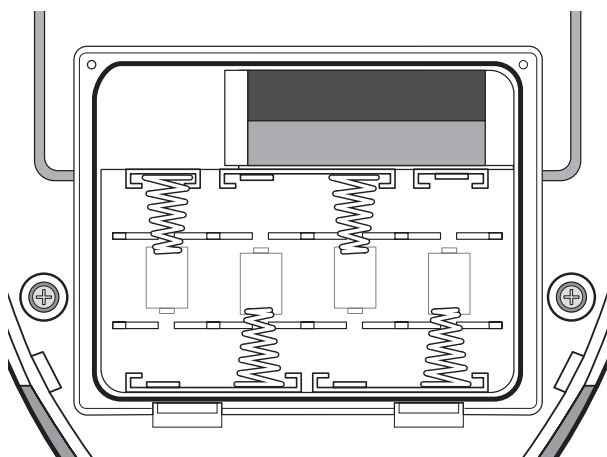

Rear view of Dummy Siren Unit

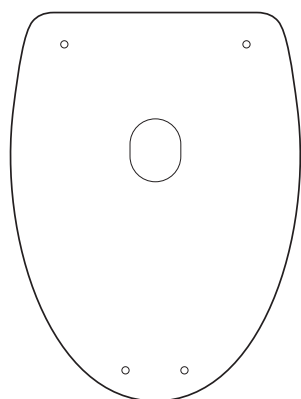

Mounting Template

On the front face of the Dummy Siren behind the red lens, you will now notice two red deterrent LEDs flashing alternately every 5 seconds.

4. Use the clear plastic mounting template to mark the positions of the four mounting holes shown. A spirit level placed on the top edge will help ensure you get the unit level.
5. Undo the fixing screw securing the mounting plate from the bottom edge of the Dummy Siren and remove the plate.
6. Drill four 6mm holes and fit the wall plugs.
7. Fit the two 30mm fixing screws in the top holes leaving approximately 9mm of the screw protruding.
8. Fit the keyhole slots in the top of the Dummy Siren over these screws and check that they form a neat fit with minimal movement. If necessary remove the Dummy Siren and adjust the screws as required.
9. Remove the Dummy Siren and fit the wall mounting plate in position using the two 25mm fixing screws.
10. Fit the Dummy Siren to the wall ensuring that the keyhole slots are correctly fitted over the heads of the two top fixing screws and the lower fixing hole lines up with the wall plate.
11. Secure the Dummy Siren in place by fitting the lower fixing screw in the wall plate. Do not over tighten the screw as this could damage the thread.

EXTERNAL CONNECTIONS

(Optional)

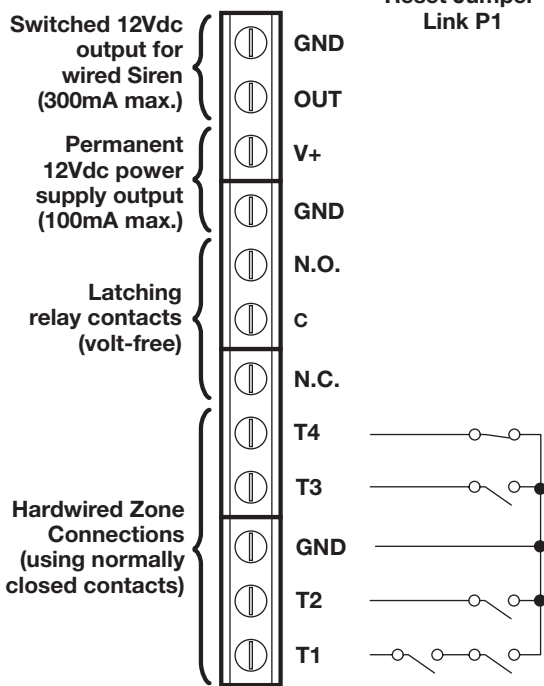
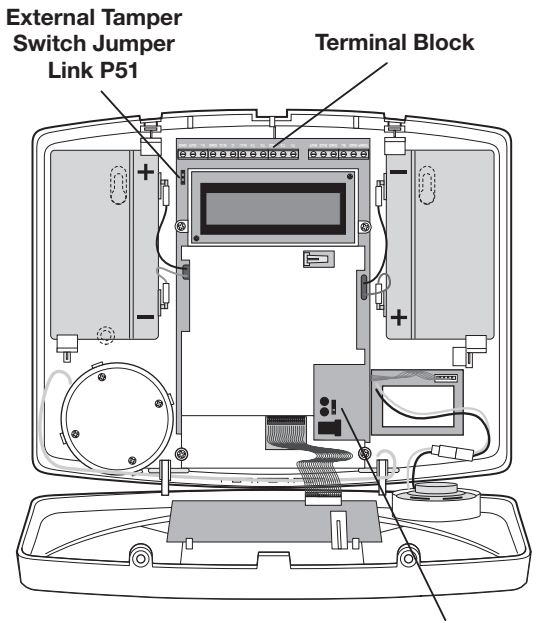

TERMINAL BLOCK DETAIL

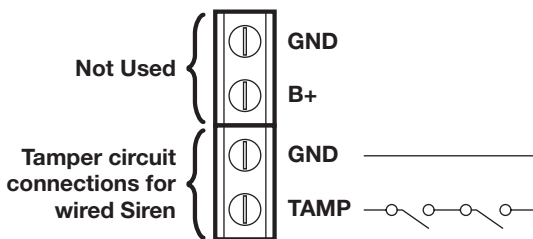

The Control Panel incorporates a terminal block for connection of a Hard-wired Siren. The connection terminal block is located inside the Control Panel behind the front cover. To access the terminal block

you must first put the system into Test Mode to prevent an alarm occurring.

To do this:

Press  , **1** **2** **3** **4** , 
User Access Code

Undo the two fixing screws on the top edge of the Control Panel and open the front cover.

Before making any connections, ensure that the Reset Jumper Link P1 is in the 'OFF' position and then remove the DC power jack and disconnect 1 of the back-up batteries.

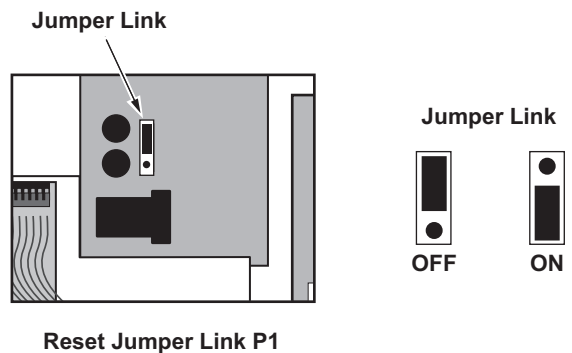

The signalling contacts on all hardwired alarm and tamper zones must be volt free. (i.e. they must only open and close and not apply any self generated voltage across the contacts).

The contacts on zones 33, 34, 35 and the tamper circuit should be normally closed. An alarm will be triggered when the contacts open. On zones 33, 34 and 35, additional Wired Magnetic Door/Window Contact Detectors can be hardwired to these terminals (by purchasing the Response Wired Door/Window Contact Accessory Pack (PW1).

The contacts on zone 36 should be normally open. An alarm will be triggered when the contacts close.

Note: The External Tamper Switch jumper link P51 should be fitted into the ON position only if the hardwired tamper circuit is used, otherwise it must be in the OFF position.

After making your external connections reconnect the power supply and back-up Battery. Then close the Control Panel cover and tighten the fixing screws on the top edge.

Press  to leave Test Mode and return to Standby.

TESTING THE SYSTEM

The Control Panel has a built in test facility to enable you to test the system at any time. However it is recommended that the system is tested at regular intervals not exceeding 3 months.

With the system in Standby

Press , , , , , 
User Access Code

The Arm and Part-Arm LEDs will flash

The system is now in Test Mode.

Note: After completing all required test functions press  to exit Test Mode and return to Standby.

Use the  and  buttons to scroll through the menu options.

Press  to select displayed test.

Press .

Note: There will be an automatic time-out period of 10 minutes while in the test mode menu and no test option has been selected. When a test option is selected, this time-out period will stop.

When a test is exited, the system returns to the test mode menu again and the time-out period will be reset to 10 minutes.

TEST FUNCTION SUMMARY

- Detector Walk Test
- Alarm Test – Wireless Siren
- Alarm Test – Internal Siren
- Alarm Test – Wired Siren
- Alarm Test – Auxiliary Relay
- Link Control Panel to Spectra Lighting
- Spectra Lighting Test
- Link Control Panel to Wireless Siren
- Wireless Siren Service Mode ON
- Wireless Siren Service Mode OFF
- Voice Dialler Test – phone number 1
- Voice Dialler Test – phone number 2
- Voice Dialler Test – phone number 3
- Voice Dialler Test – phone number 4
- Remote Manager Test – phone number 1 (Optional)
- Remote Manager Test – phone number 2 (Optional)

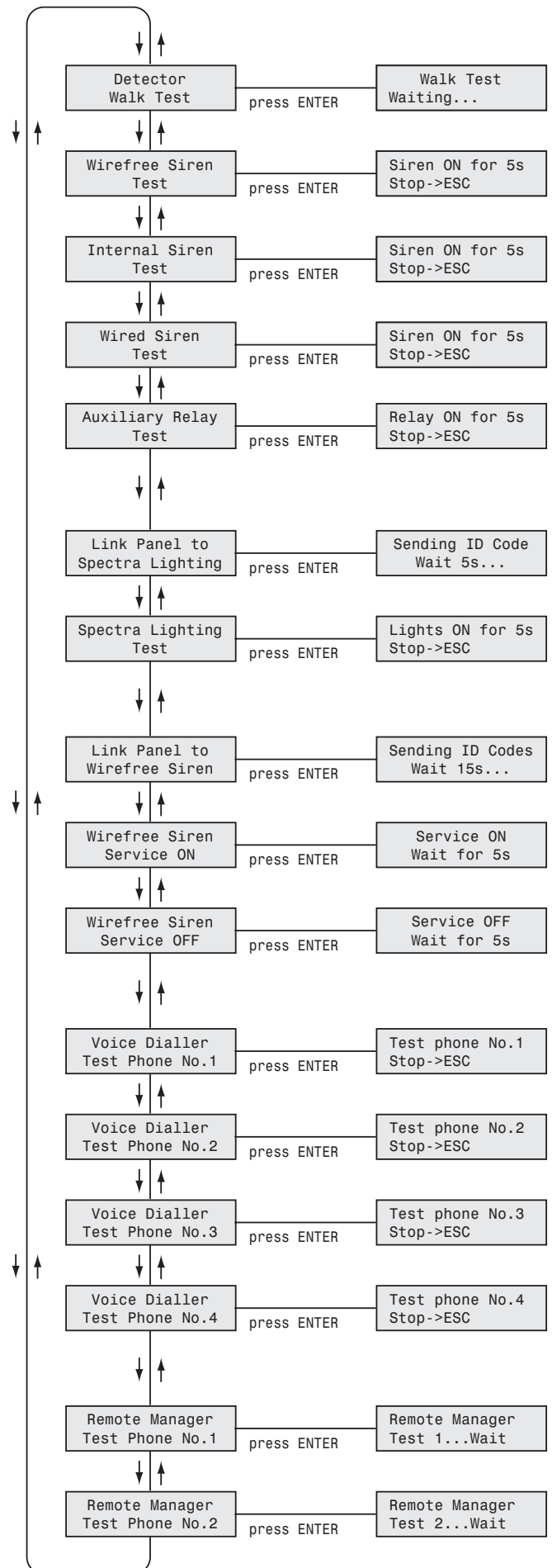

DETECTOR TEST

Before commencing testing please ensure that there is no movement in any PIR protected area for at least 3 minutes, all doors/windows protected by Door/Window Detectors are closed and that all battery covers are correctly fitted.

Note: It may be helpful to have a 2nd person to assist with this test.

Scroll through the top level Test Mode menu until 'Walk Test waiting...' is displayed and press .

If your system includes Remote Controls:

For each Remote Control:

1. Activate each button on the Remote Control in turn including the PA switch. As each button is pressed the Control panel will beep and the button name will be displayed, e.g. 'Remote Disarm' will be displayed when the  button is pressed.

If your system includes PIR Detectors:

For each Detector:

2. Ensure that the area protected by the PIR has been free from movement for at least 3 minutes and then walk into the area to trigger the detector

Note: To conserve power the PIR will only detect movement if there has been no movement detected within the previous 2 minutes.

When the detector is triggered the Control Panel will beep to indicate that a signal has been received and display the zone of the detector that was activated.

3. Remove the battery cover from the detector to operate the anti-tamper switch.

The Control Panel will beep and 'Zone x : PIR Tamper' will be displayed.

If your system includes Door/Window Detectors:

For each Detector:

4. Open the protected door/window to trigger the detector.

When the detector is triggered the Control Panel will beep to indicate that a signal has been received and display the zone of the detector that was activated.

5. Remove the battery cover from the detector to operate the anti-tamper switch.

The Control Panel will beep and 'Zone x : MAG Tamper' will be displayed.

Press  to exit Walk Test and return standby.

TEST FUNCTION SUMMARY

When signals are received from linked devices the appropriate messages will be displayed on the LCD as follows:

Remote Control/Keypad - ARM

Remote/Keypad
Arm

Remote Control/Keypad – PART-ARM 1

Remote/Keypad
Part - Arm 1

Remote Control/Keypad – PART-ARM 2

Remote/Keypad
Part - Arm 2

Remote Control/Keypad - DISARM

Remote/Keypad
Disarm

Remote Control/Keypad – PANIC/PA

Remote/Keypad
Panic/PA

PIR Detector – Alarm

Zone X : PIR
Alarm

PIR Detector – Tamper

Zone X : PIR
Tamper

MAG Detector – Alarm

Zone X : MAG
Alarm

MAG Detector – Tamper

Zone X : MAG
Tamper

Smoke Detector – Alarm

Zone X : Smoke
Alarm

Smoke Detector – Tamper

Zone X : Smoke
Tamper

ALARM TEST – WIRELESS SIREN TEST

Scroll through the menu until ‘Wirefree Siren Test’ is displayed on the LCD.

Press  to activate the wireless siren for 5s.

During the test the LCD will display:

Siren ON for 5s
Stop->ESC

Press  to stop the test early.

ALARM TEST – INTERNAL/WIRED SIREN TEST

Scroll through the menu until ‘Internal Siren Test’ is displayed on the LCD.

Press  to activate the Control Panel siren for 5s.

During the test the LCD will display:

Siren ON for 5s
Stop->ESC

Press  to stop the test early.

ALARM TEST – WIRED SIREN TEST

Scroll through the menu until ‘Wired Siren Test’ is displayed on the LCD.

Press  to activate the wired siren for 5s.

During the test the LCD will display:

Siren ON for 5s
Stop->ESC

Press  to stop the test early.

ALARM TEST – AUXILIARY RELAY TEST

Scroll through the menu until ‘Auxiliary Relay Test’ is displayed on the LCD.

Press  to activate the Auxiliary Relay (n.o./n.c.) contacts for 5s.

During the test the LCD will display:

Siren ON for 5s
Stop->ESC

Press  to stop the test early.

LINKING THE CONTROL PANEL TO SPECTRA LIGHTING RECEIVER

In order for the Control Panel to be able to activate the Spectra Lighting Receiver the panels code must be learnt into memory on the Receiver. To do this the panel must transmit a code to it.

To link the Control Panel to the Spectra Lighting Switching Receiver...

1. Place the Spectra Receiver into Learn Mode...
Send the ID codes from the panel to the Spectra Receiver...
2. Scroll through the system menu until ‘Link Panel to Spectra Lighting’ is displayed.
3. Press 

The LCD will display ‘Sending ID Code wait 5s’ for 5s.

After 3 seconds a “lights on for 10s” signal will be transmitted by the control panel to the Spectra receiver to learn the panel’s code into memory.

The Receiver will automatically exit Learn mode. ‘lights on for 10s’ signal.

SPECTRA LIGHTING TESTS

Scroll through the menu until 'Spectra Lighting Test' is displayed on the LCD.

Press  to activate the linked Spectra lighting for 5s.

During the test the LCD will display:

Lights ON for 5s
Stop->ESC

Press  to stop the test early.

WIRELESS SIREN SERVICE MODE

The Siren includes a Service Mode facility which prevents the siren's tamper switch from triggering an alarm when it is removed from the wall for maintenance or to change the batteries. After changing the batteries and refitting in position, the Siren must be put back into Operating Mode, otherwise the siren will not sound in the event of an alarm.

WIRELESS SIREN SERVICE MODE ON

Scroll through the menu until 'Wirefree Siren Service ON' is displayed on the LCD.

Press  to switch the Solar Siren into Service Mode.

The LCD will display the following for 3s while the 'Siren Service Mode ON' signal is transmitted:

Service ON
Wait...

The siren will produce two short beeps followed 1 second later by a single long beep. The Siren LEDs will flash together in conjunction with the beeps.

beep-beep beeeeeeeeeeep
|-----|
1 second

WIRELESS SIREN SERVICE MODE OFF

Scroll through the menu until 'Wirefree Siren Service OFF' is displayed on the LCD.

Press  to switch the Solar Siren into Service Mode.

The LCD will display the following for 3s while the 'Siren Service Mode OFF' signal is transmitted:

Service OFF
Wait...

The siren will produce two short beeps followed 1 second later by a single long beep. The Siren LEDs will flash together in conjunction with the beeps.

beeeeeeeeeeep beep-beep
|-----|
1 second

REMOTE MANAGER TEST (OPTIONAL) – PHONE NUMBER 1

Scroll through the menu until 'Remote Manager Test Phone No.1' is displayed on the LCD.

Press  to activate the Remote Manager dialler to call phone number 1.

1. If the Remote Manager is disabled the panel will beep and the LCD will display the following for 5s:

Remote Manager
Disabled

2. If phone number 1 is not programmed the panel will beep and the LCD will display the following for 5s:

Phone Number 1:
Not Entered

3. If phone number 1 is programmed the Remote Manager dialler will be activated and a test call will be placed to the Alarm Monitoring Service provider using phone number 1. During the test the LCD will display:

Test Phone Number 1:
Stop->ESC

If an acknowledgment signal is received from the Alarm Monitoring Service the panel will beep and the LCD will display:

Remote Manager
Test....PASS

If no acknowledgment signal is received from the Alarm Monitoring Service the panel will beep and the LCD will display:

Remote Manager
Test....FAIL

To stop the test early at the panel press .

REMOTE MANAGER TEST (OPTIONAL) – PHONE NUMBER 2

Scroll through the menu until 'Remote Manager Test: Phone No.2' is displayed on the LCD.

Press  to activate the Remote Manager dialler to call phone number 2 following the same procedure as described above for phone number 1 with the LCD displays modified to show phone number 2.

VOICE DIALLER TEST – PHONE NUMBER 1

Scroll through the menu until 'Voice Dialler Test: Phone No.1' is displayed on the LCD.

Press  to activate the Voice Dialler to call phone number 1.

1. If the Voice Dialler is disabled the panel will beep and the LCD will display the following for 5s:

Voice Dialler
Disabled

2. If phone number 1 is not programmed the panel will beep and the LCD will display the following for 5s:

Phone Number 1:
Not Entered

3. If phone number 1 is programmed the voice dialler will be activated and phone number 1 will be called. During the test the LCD will display:

Test Phone Number 1:
Stop->ESC

When the call is answered the recorded main alarm message only will be repeatedly replayed for a minimum of 60s after which time the current replay cycle will be completed and the test will end.

The recipient of the call may acknowledge the call and stop the test by pressing the  button on the telephone keypad.

If this occurs the panel will beep and display the following for 5s:

Call
Acknowledged

To stop the test early at the panel press .

VOICE DIALLER TEST – PHONE NUMBER 2

Scroll through the menu until 'Voice Dialler Test: Phone No.2' is displayed on the LCD.

Press  to activate the Voice Dialler to call phone number 2 following the same procedure as described above for phone number 1 with the LCD displays modified to show phone number 2.

VOICE DIALLER TEST – PHONE NUMBER 3

Scroll through the menu until 'Voice Dialler Test: Phone No.3' is displayed on the LCD.

Press  to activate the Voice Dialler to call phone number 3 following the same procedure as described above for phone number 1 with the LCD displays modified to show phone number 3.

VOICE DIALLER TEST – PHONE NUMBER 4

Scroll through the menu until 'Voice Dialler Test: Phone No.4' is displayed on the LCD.

Press  to activate the Voice Dialler to call phone number 4 following the same procedure as described above for phone number 1 with the LCD displays modified to show phone number 4.

FACTORY SETTINGS

USER CODE SETUP

Master User: 1234
Users 1-6: Not programmed
Duress Code: Not programmed

SYSTEM SETUP MENU

Alarm Duration: 3 minutes
Entry/Exit Delay period: 30s
Entry Delay Beeps: On
Exit Delay Beeps: On
Wireless Siren: On
Wired Siren: Off
Auxiliary Relay: Off
Jamming Detection: Off
Zone Lockout: On
Time: 12:00
Date: 01/01/07
Dial Mode: Off
Remote Phone Access: Off
Rings To Answer Phone: 6

REMOTE MANAGER SETUP

Phone Numbers 1 and 2: Not programmed
System ID Code: Not programmed

VOICE DIALLER SETUP MENU

Phone Numbers 1-4: Not programmed
Messages: Not programmed

ZONE SETUP MENU

Zone defaults set according to detector type identified during learning process:

PIR/MAG Detectors

Zone Name: No name
Zone Type: Intruder
Zone Mode: Zones 1-2: Delayed
Zones 3-36: Instant
Part-Arm 1: Zones 1-4: On
Zones 5-36: Off
Part-Arm 2: Off
Chime: Off

Smoke Detectors

Zone Name: No name
Zone Type: Fire
Zone Mode: Instant
Part-Arm 1: Off
Part-Arm 2: Off
Chime: Off

FACTORY SETTINGS

LATCH KEY SETUP

Status: OFF
Selected User Setup: OFF (all users)
Phone Numbers: Not programmed

ANSWER PHONE SETUP

Status: OFF
User status: All Off
User ID messages: Not recorded
Phone Numbers: Not programmed

SPECTRA LIGHTING SETUP

Set Light-On Period: 3 Minutes
Spectra Mode: OFF
Stop Time: 06:00
Start Time: 18:00

RESET FACTORY SETTINGS

1. Press  ,     , 
User Access Code

This puts the system into Test Mode.

2. Undo the Control Panel cover fixing screws and open the cover.
3. Remove the DC power jack, then remove and disconnect one of the back-up batteries.
4. Set jumper link P1 to the ON position.



5. Reconnect the power supply jack.
6. The Control Panel will now reset itself with all factory settings.

'EEPROM RESET' will be displayed while the factory settings are restored to memory. Once the memory reset has been completed 'DISARM READY' will be displayed.
7. Reconnect and replace the back-up battery.
8. Reset jumper link P1 into the OFF position.
9. Close the Control Panel cover and refit the fixing screws.

PROGRAMMING INSTRUCTIONS

With the system in Standby (i.e. with the display showing 'DISARM READY').

Press  ,     , 
Master User Access Code

Note: To get to Standby Mode simply press  repeatedly until only the POWER LED is illuminated.

The system is now in Program Mode.



NAVIGATING THROUGH THE PROGRAMMING MODE MENUS

(Read carefully before you start).

The programmable system parameters are arranged by group in a series of menus within programming mode.

Each menu (and sub-menu) will contain all programmable system parameters related to the particular function.

Note: Some basic system parameters will be contained within the system menu because they relate to a number of different functions.

At each menu level use the  and  buttons to scroll through the available options.

Note: A menu item displayed in full capitals (e.g. 'USER SETUP') indicates that there is another menu below that option. An option displayed in lower case (e.g. '1.0 Master User Access Code') indicates that this is a parameter setting and no menu below, (although there may be setting options).

Press  to:

- select the displayed menu, or
- change the displayed parameter setting, or
- save the changed parameter setting and revert to the previous level.

Press  to:

- exit to the previous menu level, or
- revert to the previous level without saving a changed parameter setting.

Note: After programming all required functions, press  to leave Programming mode and return to Standby.

USER SETUP MENU

Master User Access Code
User 1 Access Code
User 2 Access Code
User 3 Access Code
User 4 Access Code
User 5 Access Code
User 6 Access Code
Duress Access Code

SYSTEM SETUP MENU

Alarm Duration
Entry/Exit Delay period
Entry Delay Beeps
Exit Delay Beeps
Wireless Siren
Wired Siren
Auxiliary Relay
Jamming Detection
Zone Lockout
Time
Date
Dial Mode
Remote Phone Access Control
Rings To Answer Phone

ZONE SETUP MENU

Learn Detector Code
Zone Name
Zone Type
Zone Mode
Part-Arm 1
Part-Arm 2
Chime

LATCH KEY SETUP MENU

Status
User status
Record User ID messages
Replay User ID messages
Phone Numbers

REMOTE MANAGER SETUP MENU

Phone Numbers
System ID Code

VOICE DIALLER SETUP MENU

- Phone Numbers
- Record Alarm Messages
- Replay Alarm Messages

SPECTRA LIGHTING SETUP

- Set Light-On Period
- Spectra Mode
- Stop Time
- Start Time

TELEPHONE APPLICATION SETUP

If using any of the telephone based functions, (e.g. Answer Phone, Voice Dialler, Remote Phone Access and Control etc.) the Dial Method must be set as follows:

Remote Manager

Page 45

- | | | |
|--|---|-------------------------------|
| <ol style="list-style-type: none"> 1) set Dialler Mode = "Remote Manager" | } | see SYSTEM SETUP menu |
| <ol style="list-style-type: none"> 2) set Remote Manager Phone Numbers | } | see REMOTE MANAGER SETUP menu |
| <ol style="list-style-type: none"> 3) set System ID Code | } | |

Voice Dialler

Page 42

- | | | |
|---|---|------------------------------|
| <ol style="list-style-type: none"> 1) set Dialler Mode = "Voice Dialler" | } | see SYSTEM SETUP menu |
| <ol style="list-style-type: none"> 2) set Voice Dialler Phone Numbers | } | see VOICE DIALLER SETUP menu |
| <ol style="list-style-type: none"> 3) set Dial Sequence | } | |
| <ol style="list-style-type: none"> 4) record Alarm Messages | } | |

Answer Phone

Page 38

- | | | |
|--|---|-----------------------|
| <ol style="list-style-type: none"> 1) set Rings to Answer Phone | } | see SYSTEM SETUP menu |
|--|---|-----------------------|

Latch Key

Page 44

- | | | |
|---|---|--------------------------|
| <ol style="list-style-type: none"> 1) set Latch Key Status = "ON" or "OFF" | } | see LATCH KEY SETUP menu |
| <ol style="list-style-type: none"> 2) enable users if "ON" chosen | } | |
| <ol style="list-style-type: none"> 3) set Latch Key Phone Numbers | } | |
| <ol style="list-style-type: none"> 4) record User ID Message(s) | } | |

USER SETUP

This menu allows the 4 digit User Access Codes to be configured for each user. The general users (1-6) may also record a 4 second message to be used with the Latch Key feature in the Latch Key Setup menu.

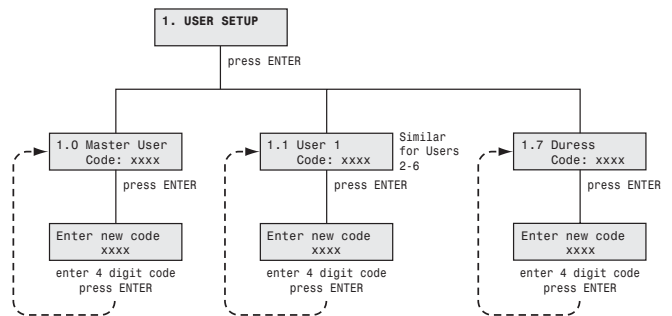

Scroll through the top level programming menu until '1. USER SETUP' is displayed and press **ENTER**.

Note: After configuring all required users, press **ESC** to return to the top level of programming menu.

MASTER USER

Default setting: 1234

Scroll through the menu until '1.0 Master User Code:' and the current access code is displayed.

To change the access code press **ENTER**.

Enter the new 4 digit User Access Code which will be displayed on the LCD.

Press **ENTER** to save new setting and exit, or

Press **ESC** to exit without saving.

Note: User must enter a 4 digit code, 1,2 or 3 digit codes are not acceptable.

USERS 1-6 and DURESS CODES:

To change User 1 access code, select '1.1 User 1 Code' from the menu and follow the procedure above.

To change User 2 access code, select '1.2 User 2 Code' from the menu and follow the procedure above.

To change User 3 access code, select '1.3 User 3 Code' from the menu and follow the procedure above.

To change User 4 access code, select '1.4 User 4 Code' from the menu and follow the procedure above.

To change User 5 access code, select '1.5 User 5 Code' from the menu and follow the procedure above.

To change User 6 access code, select '1.6 User 6 Code' from the menu and follow the procedure above.

To change the Duress access code, select '1.7 U Duress Code' from the menu and follow the procedure above.

SYSTEM SETUP

The parameters in this menu allow the configuration of general system parameters, such as Alarm Duration and control of any hardwired or output relay alarm contacts. This section also contains the basic setup information for the systems telephone dialler interface which must be configured appropriately if any of the telephone based functionality is to be used.

Refer to System Setup diagram on page 34.

Scroll through the top level programming menu until '2. SYSTEM SETUP' is displayed and press .

Note: After completing the system setup press  to return to the top level programming menu.

Scroll through the menu until '2. SYSTEM SETUP' is displayed on the LCD and press .

After configuring the system parameters press  to return to the top level programming menu.

LEARN REMOTE CONTROLS AND KEYPADS

Allows up to 6 Remote Controls or Remote keypads to be linked to the system and their ID codes learnt into memory.

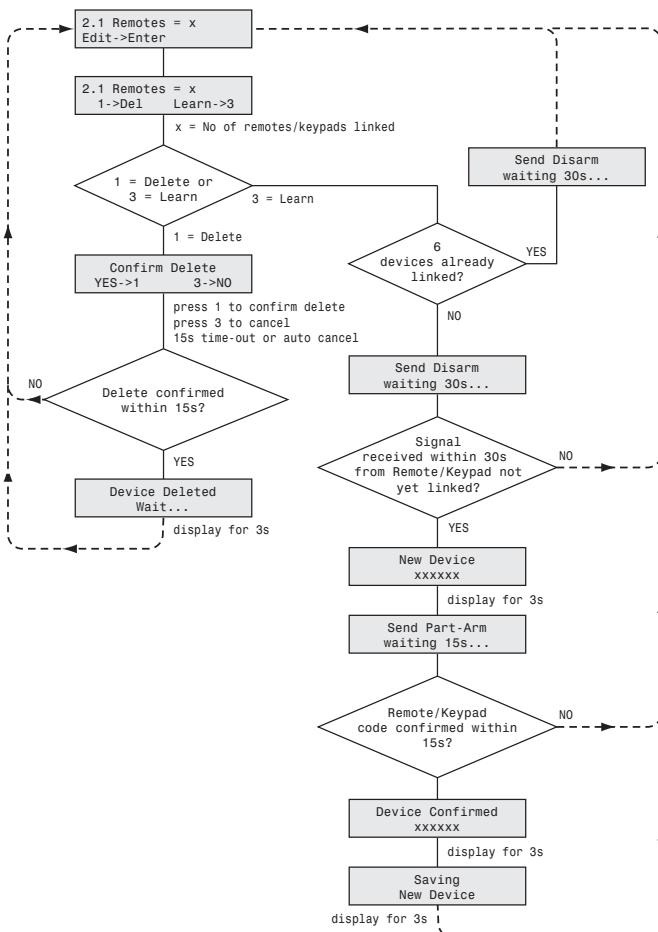

Scroll through the Zone menu until option '2.1 Remotes' is displayed. The number of Remote Controls/Keypads already linked will be shown, (e.g. if there are two Remotes Controls and one Remote Keypad linked the display will show '2.1 Remotes = 3').

Linking a Remote Control or Remote Keypad to the Control Panel:

Note: If there are already 6 Remote Controls/Keypads linked to the Control Panel then it will not be possible to link any more. Attempting to learn a 7th device will cause the panel to produce a single long beep and display 'Cannot Learn - System Full' message on screen for 3s.

To learn a new Remote or Keypad ID code and link it to the selected zone press .

The panel will now listen for a valid signal from a new Remote Control or Keypad.

The Panel will remain in Learn Mode for 30s. If a valid signal is not received from a new device within 30s it will automatically exit Learn Mode and return to the top of level 2.0.

Send DISARM from the new Remote Control or Remote Keypad as follows...

Press  on the Remote Control, or

Press     , 
Keypad User Access Code

on the Remote Keypad.

Note: If the device is already linked to the control panel then the panel will produce a single long beep and the received signal from the device will be ignored.

If the device is new and not already linked to the system the control panel will produce two short beeps and the display will show 'New Device' and the type or the detected device; (e.g. Remote or Keypad).

Confirm the new device ID code by sending the Disarm signal from the same new Remote Control or Remote Keypad within 15s as follows...

Press  on the Remote Control, or

Press     , 
Keypad User Access Code

on the Remote Keypad.

Note: If the confirmation signal is not received within 15s the control panel will produce a single long beep and exit the learning process. The learning process will need to started again to learn the new device into memory.

The panel will produce three short beeps and the LCD will show 'Device Confirmed'.

The LCD will then show 'Saving New Device' while the ID code of the new detector is stored into memory.

Deleting Linked Devices:

Scroll through the Zone menu until option '2.1 Remotes' is displayed. The number of Remote Controls/Keypads already linked will be shown, (e.g. if there are two Remotes Controls and one Remote Keypad linked the display will show '2.1 Remotes = 3').

To delete all linked Remote Controls and Remote Keypads press .

Press  again within 15s to confirm and actually delete all devices.

The display will now show '2.1 Remotes = 0'.

Note: If delete all is not confirmed within 15s then the action will be cancelled and the Remote Controls/Keypads will not be deleted and the display will revert to its original setting.

ALARM DURATION

Controls the alarm duration of the wireless, internal control panel and wired sirens in the event of an alarm, subject to the On/Off status of the wireless and hard wired sirens which can be independently controlled and disabled.

Scroll through the system menu until '2.2 Alarm Time' (and the current setting) is displayed.

Siren Duration

Default setting: 180 seconds

To change the setting press .

Enter the required Alarm Duration in units of 10 seconds (0 - 60).

e.g. enter 6 for a 60 seconds alarm duration.

minimum setting = 0. (i.e. 0 seconds / no alarm).

maximum setting = 60 . (i.e. 600 seconds or 10 minutes).

Press  to save new setting and exit, or

Press  to exit without saving.

Note: Following an alarm, the Siren will continue to sound until either the system is Disarmed; or the Alarm Duration time expires. If the '3 minute alarm time limit' of the Siren is enabled, then the Siren will shut down after 3 minutes even if the Control Panel siren is still sounding.

ENTRY/EXIT DELAY PERIOD

This sets the time entry and exit delay time period for the system. The exit delay is the period between arming the alarm and any detectors being allowed to initiate an alarm (either instant or delayed). On entering the property it sets the period between triggering a detector configured as "delayed" and the alarm occurring.

Default setting: 30 seconds

Scroll through the system menu until '2.3 Entry/Exit Delay' (and the current setting) is displayed.

To change the setting press .

Enter the required delay period (10 - 240s).

Press  to save new setting and exit, or

Press  to exit without saving.

ENTRY DELAY BEEPS

Allows the systems Entry-Delay warning beeps when arming the system to be switched ON or OFF.

Scroll through the system menu until '2.4 Entry Delay Beeps' (and the current setting) is displayed.

To change the setting press .

Press  to enable the entry delay beeps, or

Press  to disable the entry delay beeps.

EXIT DELAY BEEPS

Allows the systems Entry-Delay warning beeps when arming the system to be switched ON or OFF. .

Scroll through the system menu until '2.5 Exit Delay Beeps' (and the current setting) is displayed.

To change the setting press .

Press  to enable the exit delay beeps, or

Press  to disable the exit delay beeps.

WIRELESS SIREN

Allows the wireless siren to be enabled or disabled. If disabled it will not sound in the event of any alarm.

Default setting: ON

Scroll through the system menu until '2.6 Wirefree Siren' (and the current setting) is displayed.

To change the setting press .

Press  to enable the wireless siren, or

Press  to disable the wireless siren.

WIRED SIREN

Allows the hard wired siren to be enabled or disabled. If disabled it will not sound in the event of any alarm. (This does not affect the control panels internal siren

which cannot be de-activated unless the alarm duration is set to 0).

Scroll through the system menu until '2.7 Wired Siren' (and the current setting) is displayed.

To change the setting press .

Press  to enable the wired siren, or

Press  to disable the wired siren.

AUXILIARY RELAY

Controls the operation of the auxiliary relay in the event of an alarm occurring.

Scroll through the system menu until '2.8 Aux Relay' (and the current setting) is displayed.

To change the setting press .

Scroll through the menu options, until the required setting is displayed.

Options: OFF / 2s / 30s / 60s / 180s / 300s / On-until-disarm

Press  to save the new setting, or

Press  to exit without saving.

JAMMING DETECTION

This controls the systems anti-jamming detection facility. It is recommended that the jamming detection is not activated for at least the first 30 days to allow time for you to become familiar with the operation of your systems first.

Allows the control panels internal jamming detection feature to be enabled or disabled. (The jamming detection in the wireless siren cannot be enabled with SK5 Platinum systems).

Default setting: OFF

Scroll through the system menu until '2.9 RF Jamming Detection' (and the current setting) is displayed.

To change the setting press .

Press  to enable jamming detection, or

Press  to disable jamming detection.

ZONE LOCKOUT

Prevents a single zone from triggering an alarm more than 3 times before the system is disarmed. (Zone lockout is effective on all zones except 24-HOUR-INTRUDER and FIRE zones which cannot be locked out).

Default setting: ON

Scroll through the system menu until '2.10 Zn Lockout' (and the current setting) is displayed.

To change the setting press .

Press  to enable zone lockout, or

Press  to disable zone lockout.

TIME & DATE SETUP

These parameters allow the systems clock and calendar (required for the Event Log) to be configured.

Note: The clock will require updating to reflect any time changes due spring/autumn daylight saving.

DATE

To change the system date scroll through the menu until '2.12 Date' (and current setting) is displayed and press .

Press  to save new setting and exit, or

Press  to exit without saving.

TIME

To change the system date scroll through the menu until '2.11 Time' (and current setting) is displayed and press .

Enter the new time in the format "hh:mm" using the 24 hour clock format.

Press  to save new setting and exit, or

Press  to exit without saving.

REMOTE PHONE ACCESS AND CONTROL

If enabled, this allows the system to be remotely controlled via the telephone.

Default setting: OFF

Scroll through the system menu until '2.14 Remote Phone Control' (and the current setting) is displayed.

To change the setting press .

Press  to enable remote phone control, or

Press  to disable remote phone control.

DIALLER OPERATING MODE

Controls whether the telephone dialler is activated and whether it operates with the Remote Manager or Voice Dialler features.

Scroll through the system menu until '2.13 Dialler Mode' (and the current setting) is displayed.

To change the setting press .

Scroll through the menu options, until the required setting is displayed.

Options: OFF / Voice Dialler / Remote Manager

Press  to save the new setting, or

Press  to exit without saving.

RINGS TO ANSWER PHONE

This sets the number of rings which occur before the Control Panel will "pick up" an incoming call to operate with the Remote Phone Access and Control feature.

Default setting: 6

Scroll through the system menu until '2.15 Rings To Answer Phone' (and the current setting) is displayed.

To change the setting press .

Enter the required number of rings (options 1-9).

Press  to save the new setting, or

Press  to exit without saving.

ZONE SETUP

The parameters in this menu allow each zones specific function to be configured.

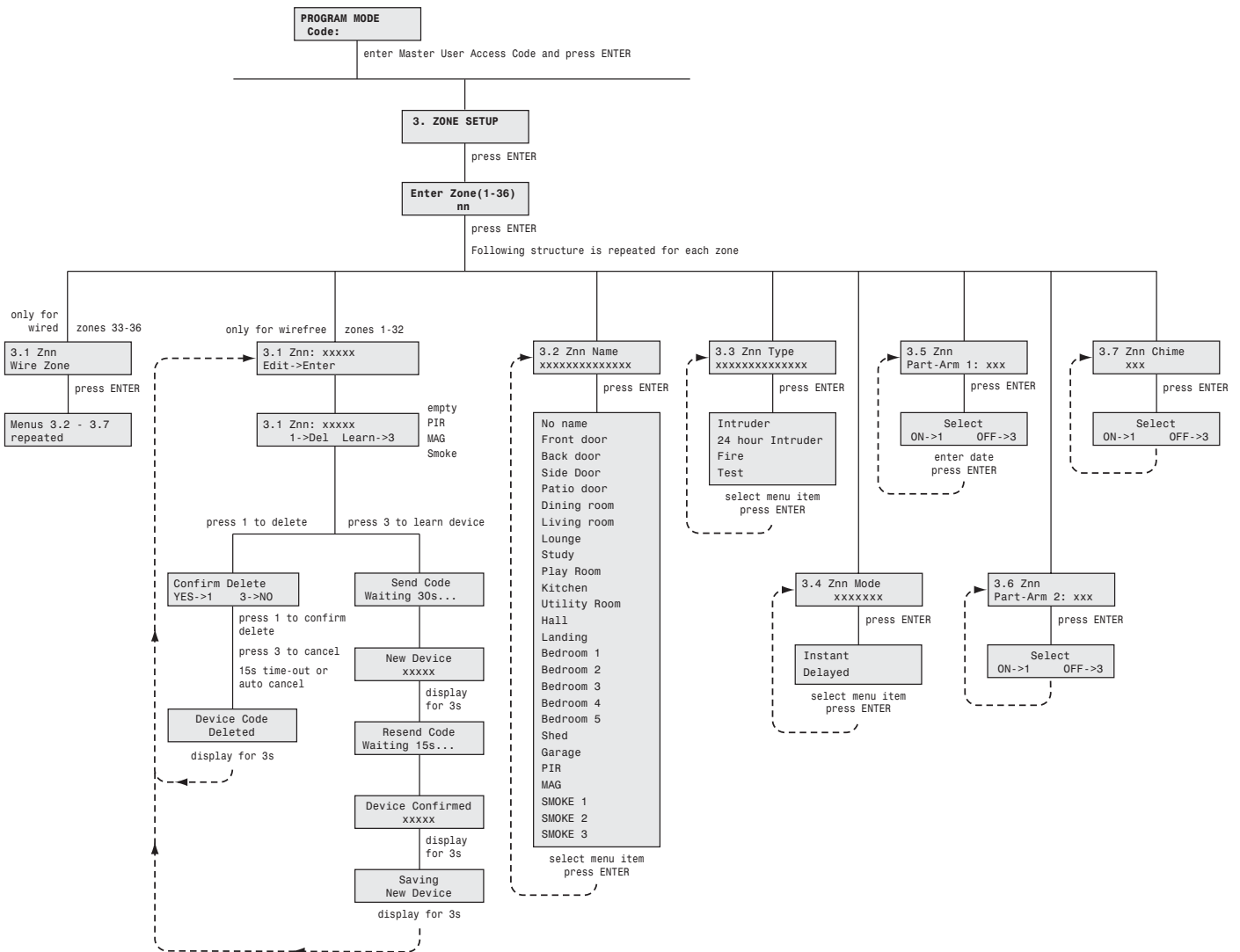

Scroll through the programming menu until '3. ZONE SETUP' is displayed and press **ENTER** .

Enter the zone number to be configured (1 - 36) and press **ESC** .

The following configuration options are based upon setting zone 1. Options for all other zones (2-10) are identical except the zone number reference will change according to the zone being configured.

Zones 33-36, the wired zones are the same except there is no learn menu option as these are wired.

Note: After completing the Zone Setup press **ESC** to return to the top level programming menu.

LEARN DETECTOR CODE

(zones 1-32 only).

Allows a wireless detectors ID code to be learnt and linked to the selected wireless zone.

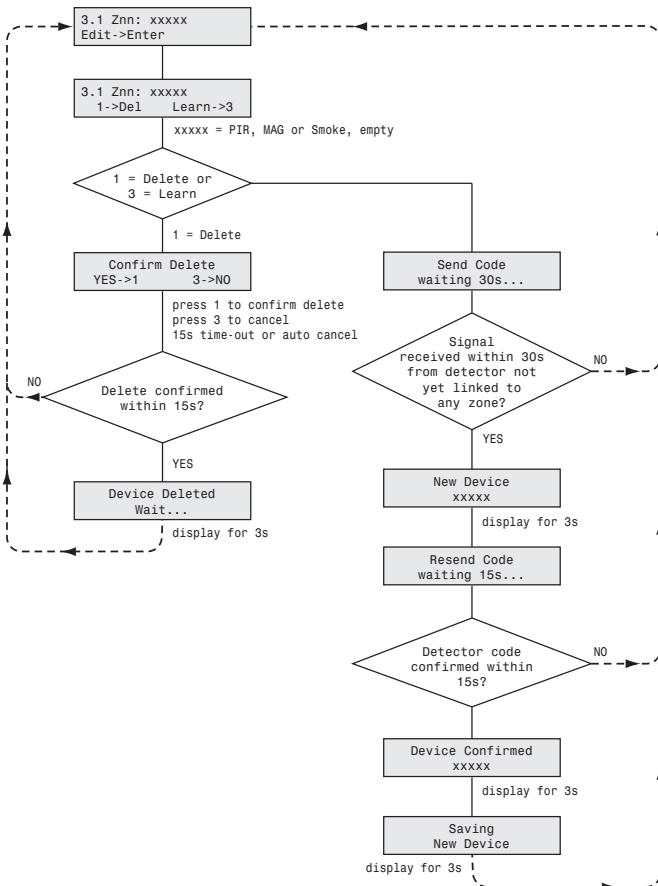

Linking a New Detector to the Zone:

Note: There can only be one detector on each zone so if a detector is already linked then linking a new detector will replace the existing one.

To learn a new detector ID code and link it to the selected zone press **3**.

The panel will now listen for a valid signal from a new detector to link to the zone.

The Panel will remain in Learn Mode for 30s. If a valid signal is not received from a new detector within 30s it will automatically exit Learn Mode and return to the top of level 3.1.

Activate the Tamper Switch on the PIR/MAG detector or trigger a smoke detector via its test button.

Note: If the detector is already linked to the control panel on any other zone then the panel will produce a single long beep and the received signal from the detector will be ignored.

If the detector is new and not already linked on any security zone the panel will produce two short beeps and the display will show 'New Device' and the type of the detected device; (e.g. PIR, MAG or Smoke).

Confirm the new device ID code by activating the Tamper Switch on the same new PIR/MAG detector or triggering the same smoke detector with its test button within 15s.

Note: If the confirmation signal is not received within 15s the control panel will produce a single long beep and exit the learning process. The learning process will need to be started again to learn the new device into memory.

The panel will produce three short beeps and the LCD will show 'Device Confirmed'.

The LCD will then show 'Saving New Device' while the ID code of the new detector is stored into memory.

Deleting an Existing Device:

If a detector is already linked then the display will show the detector type, for example: '3.1 Zxx: PIR'. The detector can be removed from the system and its ID code erased from memory without replacing it as follows:

To delete the current detector from the zone press **1**.

Press **1** again within 15s to confirm and actually delete the device.

The display will now show '3.1 Zxx: empty'.

Note: If delete all is not confirmed within 15s then the action will be cancelled and the device will not be deleted and the display will revert to level 3.1 as before.

NAME

This enables a name to be allocated to the zone so it can be identified by its location.

Available for all zones 1- 36. Only available for wireless zones 1-32 if a detector is linked.

Default setting: No Name

Scroll through the Zone menu until '3.2 Zxx Name' (and the current setting) is displayed.

To change the setting press .

Scroll through the menu options, until the required setting is displayed.

Options: No name, Front Door, Back Door, Side Door, Patio Door, Dining Room, Living Room, Lounge, Study, Play Room, Kitchen, Utility Room, Hall, Landing, Bedroom 1, Bedroom 2, Bedroom 3, Bedroom 4, Bedroom 5, Shed, Garage, PIR, MAG or SMOKE.

Press  to save the new setting, or

Press  to exit without saving.

TYPE

Each zone may be programmed to operate in 1 of 4 different modes dependant upon the type of alarm function required. The following types are available:

Intruder - provides standard intruder monitoring.

24 Hour Intruder - used to provide 24 hour monitoring of areas requiring continuous security protection even while the system is Disarmed, (e.g. gun lockers). Activation of any detector on a security zone will immediately initiate an Alarm.

Fire - used to provide 24 hour monitoring of any Fire/Smoke detectors fitted to the system. Activation of any detector will immediately initiate an Alarm.

Test - when the system is armed, any detector on the zone will generate an entry in the Event Log without initiating an alarm.

Default setting: Intruder

Scroll through the Zone menu until '3.3 Zxx Type' (and the current setting) is displayed.

To change the setting press .

Scroll through the menu options, until the required setting is displayed.

Press  to save new setting and exit, or

Press  to exit without saving.

ZONE MODE

Each zone may be selected to operate with or without a entry/exit delay period (see System Setup menu). This is selected in zone mode.

**Default setting: Zones 1-2: Delayed
Zones 3-36: Instant**

Available for all zones 1- 36. Only available for wireless zones 1-32 if a detector is linked

Scroll through the Zone menu until '3.4 Zxx Mode' (and the current setting) is displayed.

To change the setting press .

Scroll through the menu options, until the required setting is displayed.

Options: Instant / Delayed

Notes: *Smoke detectors can only be set as Instant*

Press  to save new setting, or

Press  to exit without saving.

PART-ARM 1

This controls whether the zone is active when Part-Arm 1 is armed.

**Default setting: Zones 1-4: ON
Zones 5-36: OFF**

Scroll through the Zone menu until '3.5 Zxx Part-Arm 1' (and the current setting) is displayed.

To change the setting press .

Press  to enable the zone in part arm 1, or

Press  to disable the zone in part arm 1.

PART-ARM 2

This controls whether the zone is active when Part-Arm 2 is armed.

Default setting: OFF (all zones)

Scroll through the Zone menu until '3.6 Zxx Part-Arm 2' (and the current setting) is displayed.

To change the setting press .

Press  to enable the zone in part arm 2, or

Press  to disable the zone in part arm 2.

CHIME

This controls whether the zone will operate with Chime Mode.

Default setting: OFF

Available for all zones 1- 36 only if detector is a PIR/MAG. Only available for wireless zones 1-32 if a detector is linked. Smoke detectors automatically disabled in Chime Mode.

Scroll through the Zone menu until '3.7 Zxx Chime' (and the current setting) is displayed.

To change the setting press .

Press  to enable the zone in chime mode, or

Press  to disable the zone in chime mode..

MONITORING SETUP

REMOTE MANAGER

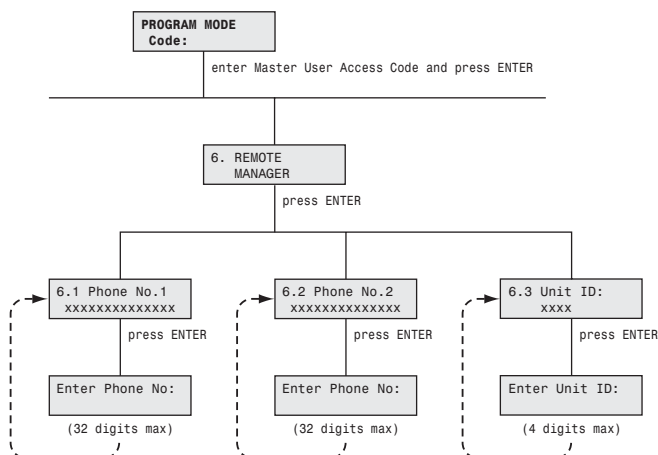

The parameters in this menu configure the system telephone dialler to interface to the Alarm Monitoring Service following the occurrence of an appropriate alarm or system event.

Note: For the telephone dialler to operate correctly with the Alarm Monitoring Service the 'Dialler Mode' (see System Setup) must be correctly set and programmed.

Scroll through the menu until '6. REMOTE MANAGER SETUP' is displayed and press .

Note: After completing the Remote Manager Setup press  to return to the top level programming menu.

PHONE NUMBER 1

Scroll through the menu until '6.1 Phone No.1:' is displayed and press .

Enter phone number 1 (see the Monitoring welcome leaflet enclosed).

Notes:

Press  to insert a 3.5 seconds pause in the dialling sequence.

Press  to move the cursor left.

Press  to move the cursor right.

Press  to delete the number under the cursor.

Press  (and hold) to erase the entire number.

Press  to save new setting and exit, or

Press  to exit without saving.

PHONE NUMBER 2

To setup Remote Manager phone number 2 select '6.2 Phone No.2:' from the menu and follow the procedure above.

UNIT ID CODE

Scroll through the menu until '6.3 Unit ID:' is displayed and press .

Enter the 4 digit System ID Code obtained from the Alarm Monitoring Service provider (see the Monitoring welcome leaflet enclosed).

This is not to be confused with the System Access Code or any User Access Codes.

Notes:

To enter code B, press  , **1**

To enter code C, press  , **2**

To enter code D, press  , **3**

To enter code E, press  , **4**

To enter code F, press  , **5**

Press  to save new setting and exit, or

Press  to exit without saving.

VOICE DIALLER

The parameters in this menu allow the setting of the systems Voice Dialler. It allows up to 4 phone numbers to be entered and called in sequence. The alarm voice messages are also recorded here.

Note: For the Voice Dialler to operate correctly the 'Dialler Mode' (see system setup) must be correctly set and programmed.

Ensure all Alarm Messages are recorded (see Record Alarm Messages, right).

Refer to Voice Dialler Setup diagram on page 44.

Scroll through the programming menu until '5. VOICE DIALLER SETUP' is displayed and press  .

Note: After completing the Voice Dialler Setup press  to return to the top level programming menu.

PHONE NUMBERS

Scroll through the menu until '5-1 PHONE NUMBERS' is displayed and press  .

Scroll through the menu until the required 'Phone No._' (and the current setting) is displayed.

To change the setting press  .

Enter the new phone number (32 digits max.)

Notes:

Press  to insert a 3.5 seconds pause in the dialling sequence.

Press  to move the cursor left.

Press  to move the cursor right.

Press  to delete the number under the cursor.

Press  (and hold) to erase the entire number.

Press  to save and exit, or

Press  to exit without saving.

After programming all required phone numbers press  to return to the top level Voice Dialler menu.

RECORD ALARM MESSAGES

Scroll through the menu until '5.2 RECORD ALARM MESSAGES' is displayed and press  .

Scroll through the available menu options until the required message to be recorded is displayed.

- a) Main message (12 seconds max.).
- b) Intruder Alarm message (5 seconds max.).
- c) Fire Alarm message (5 seconds max.).
- d) Panic/PA Alarm message (5 seconds max.).
- e) Duress alarm message (5 seconds max.).

To change the setting press  .

Press **1** to start the voice recorder.

After recording, press  to stop the recorder and cancel any remaining recording time. The new message will then be replayed.

Press **3** to exit without saving

Press  to return to the top level Voice Dialler Setup menu.

REPLAY ALARM MESSAGES

Scroll through the menu until '5.2 RECORD ALARM MESSAGES' is displayed and press  .

Scroll through the menu options until the required message is displayed and press  to replay the message.

Press  to return to the top level Voice Dialler menu.

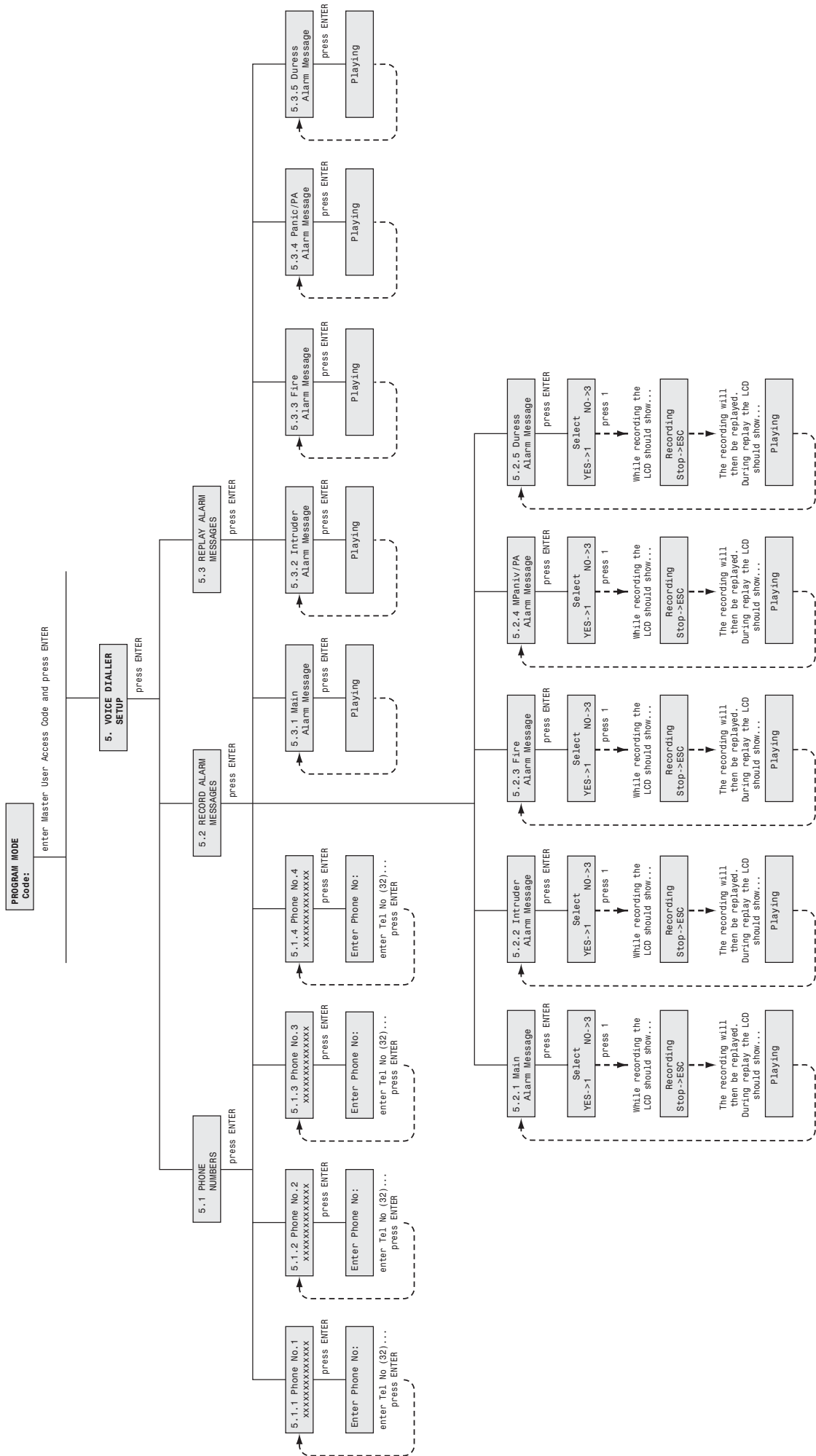

Voice Dialler Setup Diagram

LATCH KEY SETUP

The parameters in this menu configures which users the Latch Key feature operates with and the telephone numbers that the system dials when the Latch Key is activated.

Note: For Latch Key to operate correctly, the User Access Code, Latch Key Status, User Status, Latch Key Message and Phone number must be correctly set and programmed.

Note: To allow the Latch Key to operate before the system is disarmed, the User Access Code must be programmed (see page 33).

Scroll through the top level programming menu until '4. LATCH KEY SETUP' is displayed and press .

Note: After completing the Latch Key Setup press  to return to the top level programming menu.

STATUS

This controls which users the Latch Key facility will operate with.

Default setting: OFF

Scroll through the Zone menu until '4.0 Status' (and the current setting) is displayed.

To change the setting press .

Press  to enable Latch Key, or

Press  to disable Latch Key.

LATCH KEY USER SETUP

This configures the individual users that the Latch Key operates with when set to 'Selected-Users'.

Default setting: OFF

Scroll through the menu until the required user number is displayed (e.g. '4.1 User 1 Setup') and press .

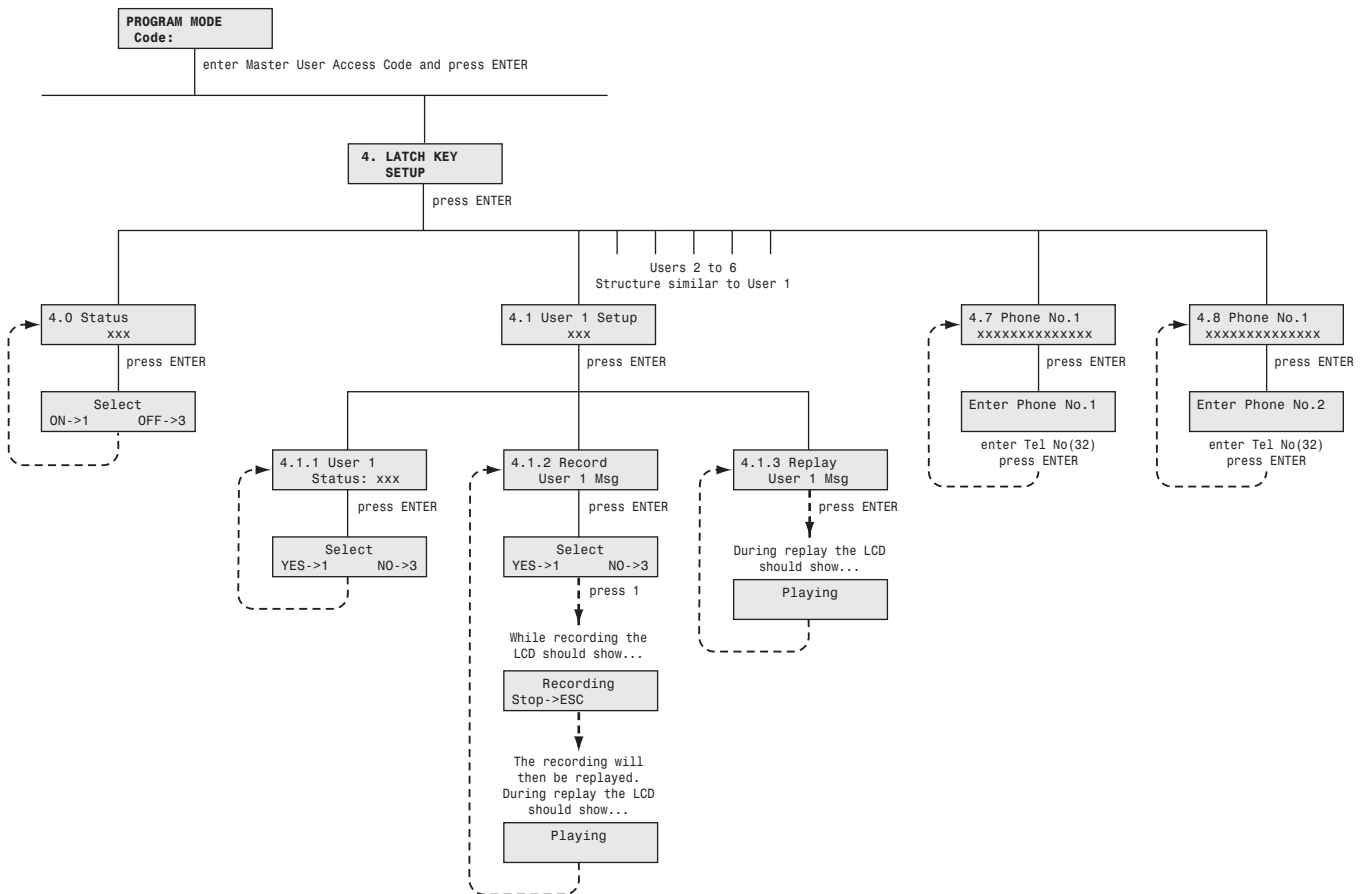



After configuring required users press  to return to the top level Latch Key menu.

User Status

Scroll through the system menu until 'User x Status' (and the current setting) is displayed.

To change the setting press .

Press  to enable user x with Latch Key, or

Press  to disable user x with Latch Key.

After configuring all users as required press  to return to the top level Latch Key Setup menu.

RECORDING USER ID MESSAGES

Scroll through the menu until 'Record User x Msg' is displayed and press .

To record the selected alarm message press .

Press  to exit without saving.

Press  to start the voice recorder and record a new message.

To stop recording before the maximum message length has expired press .

This ends the recording and cancels any remaining recording time.

After recording the new message will automatically be replayed.

REPLAYING USER ID MESSAGES

Scroll through the menu until 'Replay User x Msg' is displayed and press .

Press  to stop the message playback early.

PHONE NUMBERS

Scroll through the menu until '4.7 PHONE NUMBERS' is displayed and press .

Scroll through the menu until the required 'Phone No._' (and the current setting) is displayed.

To change the setting press .

Enter the new phone number (32 digits max.)

Notes:

Press  to insert a 3.5 seconds pause in the dialling sequence.

Press  to move the cursor left.

Press  to move the cursor right.

Press  to delete the number under the cursor.

Press  (and hold) to erase the entire number.

Press  to save and exit, or

Press  to exit without saving.

After programming all required phone numbers press  to return to the top level Latch Key Setup menu.

FRIEDLAND SPECTRA PLUS LIGHTING SETUP

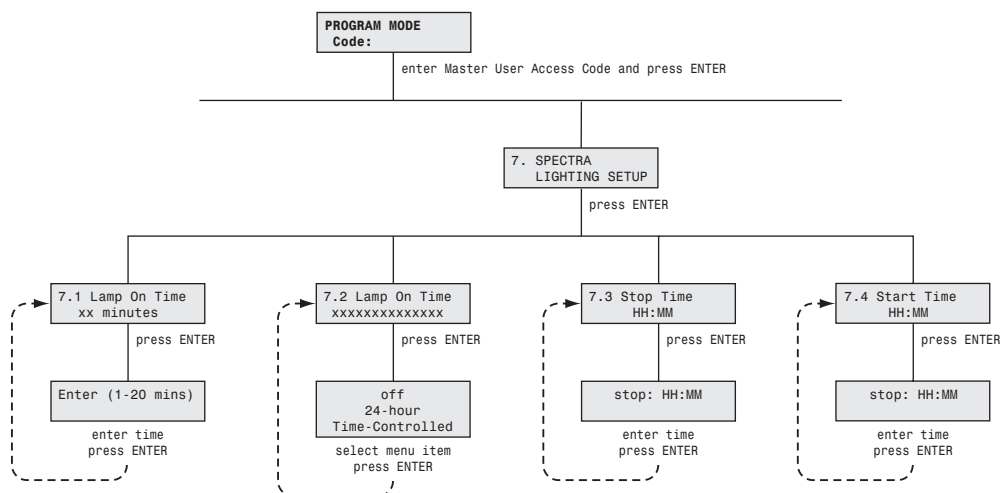

Scroll through the menu until '7. SPECTRA LIGHTING SETUP' is displayed on the LCD and press **ENTER**.

After configuring the Spectra Plus lighting press **ESC** to return to the top level programming menu.

SET LIGHT-ON PERIOD

This controls the time period for which any linked Spectra lighting is switched on for following an alarm condition.

Scroll through the system menu until '7.1 Lamp On Time' (and the current setting) is displayed.

To change the setting press **ENTER**.

Enter the required light-on period (1 to 20 minutes).

Press **ENTER** to save the new setting, or

Press **ESC** to exit without saving.

SET LIGHTING OPERATING MODE

This controls whether the Spectra Lighting is active and if it operates on a 24 hours basis or is time controlled. If time controlled it means that the user can set the time in the morning after which an alarm will no longer cause the lights to activate and the time in the evening after which an alarm will allow the lights to be activated again. This prevents the lights from being triggered during the day.

Scroll through the system menu until '7.2 Spectra Mode' (and the current setting) is displayed.

To change the setting press **ENTER**.

Options: OFF / 24-Hour / Time-Controlled

Press **ENTER** to save the new setting, or

Press **ESC** to exit without saving.

STOP TIME

This controls the time of day after which triggering an alarm will no longer be able to activate the Spectra Lighting.

Scroll through the system menu until '7.3 Stop Time' (and the current setting) is displayed and press **ENTER**.

Enter the new time in the format 'hh:mm' using the 24 hour clock format.

Press **ENTER** to save the new setting, or

Press **ESC** to exit without saving.

START TIME

This controls the time of day after which triggering an alarm will be able to activate the Spectra Lighting.

Scroll through the system menu until '7.4 Start Time' (and the current setting) is displayed and press **ENTER**.

Enter the new time in the format 'hh:mm' using the 24 hour clock format.

Press **ENTER** to save the new setting, or

Press **ESC** to exit without saving.

OPERATING INSTRUCTIONS

When leaving the premises, the system must be Armed. However, before doing so, check that all windows are closed and locked, all protected doors are closed and PIR Detectors are not obstructed. Ensure that pets are restricted to areas not protected by PIR Detectors.

The system has 3 arming modes, ARM, Part-Arm 1 and Part-Arm 2. The Part-Arm modes allow for selected zones to be left in a Disarmed state whilst the remainder of the system is Armed.

When the system is Armed the mode being activated will be displayed on the screen followed by the status of the Latch Key feature. The programmed system exit-delay will be displayed and counted down on the screen. If exit-delay beeps are enabled the panel will beep with the beep rate increasing in steps as the exit-delay expires. At the end of the Exit period all active zones will be fully Armed. By this time the user must have left the property and closed the final protected door.

If while the system is armed a detector on an active zone is triggered the programmed entry-delay for that zone will be displayed and counted down on the screen. If entry-delay beeps are enabled the panel will beep with the beep rate increasing in steps as the entry-delay expires. If the system has not been Disarmed when the entry-delay expires a Full Alarm will occur. (Note: if the entry-delay for the zone triggering the alarm is disabled then an alarm will occur immediately the detector is triggered instead). Details of the zone event that triggered the alarm will be recorded in the Event Log.







At the end of the set alarm duration the Siren and Control Panel alarms will stop and the system will automatically re-Arm itself, (subject to the conditions of the Zone Lockout feature).

Notes:

- To conserve power and maximise battery life the PIR detector will only detect movement if there has been no movement detected within the previous 2 minutes.
- If the Solar Siren is fitted and the 3 minute limit is enabled then the siren will stop when the programmed alarm duration expires or after 3 minutes, whichever occurs first.







ARMING THE SYSTEM

The system can be set in FULL ARM mode using either the Remote Control or the Control Panel as follows:

- Press  on the Remote Control, or
- Press , , , , , ,
User Access Code
on the Control Panel.









PART-ARMING THE SYSTEM: PART-ARM 1

The system can be set in PART-ARM 1 mode using either the Remote Control or the Control Panel as follows:

- Press  on the Remote Control, or
- Press , , , , , ,
User Access Code
on the Control Panel.







PART-ARMING THE SYSTEM: PART-ARM 2

The system can be set in PART-ARM 2 mode using either the Remote Control or the Control Panel as follows:

- Press ,  on the Remote Control, or
- Press , , , , , , ,
User Access Code
on the Control Panel.

DISARMING THE SYSTEM

The system can be Disarmed using either the Remote Control or the Control Panel as follows:

- Press  on the Remote Control, or
- Press , , , , , ,
User Access Code
on the Control Panel.

If the system has been triggered the 'ALARM MEM' LED will flash and the panel will beep every 10 seconds.

To stop the LED flashing and panel beeping either

- a. Press  or
- b. Inspect the Event Log to find out the cause of the alarm.

Note: If the system is Disarmed with the Remote Control the Siren will beep twice, (unless the warning beeps have been disabled on the Siren).

DISARMING THE SYSTEM WITH THE DURESS CODE

If the system is disarmed at the Control Panel using the Duress Access code the system will Disarm as normal. However, the Voice Dialler or Remote Manager dialler will be activated (after the 30s dialler delay) and the appropriate duress message sent.

The dialler Line LED will not be illuminated during this call.

FRIEDLAND SPECTRA PLUS LIGHTING

If the control panel is linked to a Spectra plus Lighting Receiver and the Spectra lighting Control is enabled then any alarm condition (except Fire alarms) will cause the linked lighting to be switched on for the set light-on duration.



Spectra Enabled	Spectra Disabled	Spectra Enabled
Alarm conditions will trigger Spectra lighting	Alarm conditions will not trigger Spectra lighting	Alarm conditions will trigger Spectra lighting

If the spectra lighting is configured as 24-hour then the lights will be triggered at any time an alarm occurs. However, if it is configured as time controlled then the lights will only be triggered if the alarm occurs either before the programmed stop time or after the start time. If the alarm occurs between the stop and start times the lights will not be triggered.

Notes:

1. Spectra lighting signal to be sent (subject to mode and timed programmed settings) each

time a Tamper or PA switch is triggered and each time a detector on an enabled zone is triggered when the panel is armed.

2. Spectra lighting will not be triggered by Smoke Alarm events.

Spectra Manual-On/Auto switching:

Press  switch the linked Spectra lighting ON.

Press  to switch the linked Spectra lighting OFF and back to automatic operation.

QUICK SET

The Quick Set function fully arms the system with a 10s second exit delay:

Press , , , , , 

User Access Code

on the Control Panel.

Alternatively, pressing  during the exit-delay period of any armed mode (including Part-Arm 1 and Part-Arm 2) will reset the remaining exit-delay period to 5 seconds.

PERSONAL ATTACK (PA) ALARM

An alarm can be immediately triggered at any time (whether the system is Armed or Disarmed) in the event of threat or danger by activating a Personal Attack (PA) switch on either the Remote Control or the Control Panel as follows:

- a. Slide the Personal Attack switch on the Remote Control upwards, or
- b. Press and hold the  button for approximately 3 seconds on the Control Panel.

The alarm will continue either for the alarm duration when the system will automatically reset or until the system is disarmed.

LATCH KEY

If the Latch Key function is enabled and the system is disarmed by a user that is enabled for Latch Key then...

1. The first Latch key phone number will be called (if entered).
2. 10s after the number is dialled the appropriate User ID message will be replayed.

The appropriate user ID message will be repeated continuously for 60s. After 60s has elapsed the current message play cycle will be completed and then the call will be terminated. This ensures the message is not cut off part way through.

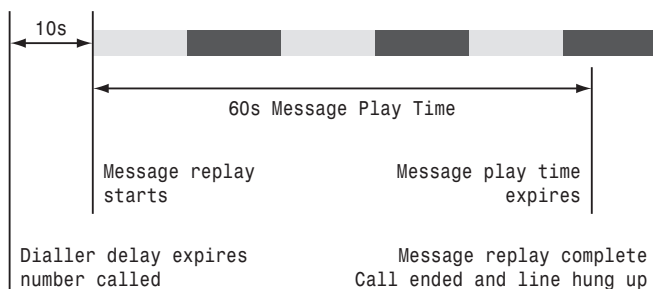

3. There is a 10s delay before the second latch Key phone number is dialled (if entered).
4. After both entered numbers have been dialled once. There will be a 30s delay before the next call sequence is started again from the first entered number.

The dialler sequence can be stopped early by either...

- a. All numbers have been dialled three times
- b. A call is acknowledged by the recipient pressing the button on the telephone keypad.

ZONE LOCKOUT

If while the system is armed a single alarm zone triggers an alarm more than three times and zone lockout is enable then the particular zone will be "locked out" and any further alarm signals from that zone will be ignored by the siren and an alarm will not be triggered again during that armed session. The zone lockout will be cancelled when the siren is disarmed.

If zone lockout is disabled then there is no limit to the number of alarms that any single zone can initiate. Zone lockout is applicable to Alarm zones only. It does not operate with the Fire zone.

DEVICE TAMPER

The Tamper zone operates on a 24 hour basis. (i.e. Receipt of a Tamper signal form any device will immediately trigger an alarm irrespective of systems armed/disarmed status unless the system is in program or Test modes).

If the battery cover of any device (except a Remote Control) is removed or if the Siren or Control Panel are removed from the wall then an alarm will immediately occur (unless the system is in Test or Program modes), even if the system is Disarmed.

The Alarm will sound until the set alarm duration time expires or the system is Disarmed from the Remote Control or Keypad. The 'ALARM MEM' LED on the Control Panel will flash and the panel will beep every few seconds to indicate an alarm has occurred.

CHIME

The Chime facility can only be operated with the system in Standby mode.

Press to toggle the Chime facility between ON and OFF.

Also see page 39 in Zone Setup menu, 3.7 Znn Chime to enable the required zone.

KEYBOARD BEEP MUTE

The keyboard beeps can be temporarily switch on/off by pressing .

ENTRY/EXIT BEEPS

If the entry/exit delay beeps are enabled then they may be temporarily switched OFF during the active delay period only by pressing .

When the next entry/exit delay periods starts the beeps will follow the main system setting as normal.



EVENT LOG

Any new event entered into the event log will be indicated by the 'Alarm Msg' LED flashing every 5 seconds.

Note: Alarm events only will cause the panel to beep every 10s, other system events entered into the event log (e.g. low battery) will not initiate the warning beeps.

To stop the LED flashing press  or access the Event Log to read the event message.

To read the event log press  from Standby.

Use  and  to manually scroll through the events. Events are displayed starting with event 1 which is the most recent through to event 99.

Note: The Event Log will not automatically scroll through the display as before.

Press  to return to Standby.

Event Log Message Structure:

The event log messages are to be structured as follows. This allows each event to be displayed on a single screen and not split across two screens. The top line being the event header detailing the event number and when the event occurred and the second line detailing the actual event:

E74: 13/03 14:23
Z12 Smoke LowBat

e.g. Event 74 occurred on 13th March at 2:23pm,
Zone 12 – smoke detector – low battery

Header: 'Enn: DD/MM hh:mm'

Where: nn = event number, 01 through to 99
DD = event date
MM = event month
hh = event hour
mm = event minute

Event Messages:

Zone Event Messages:

Zxx PIR Alarm
Zxx PIR Tamper
Zxx PIR LowBat
Zxx MAG Alarm
Zxx MAG Tamper
Zxx MAG LowBat
Zxx Smoke Alarm
Zxx Smoke Tamper
Zxx Smoke LowBat

User Event Messages:

User x Arm
User x Disarm
User x PartArm 1
User x PartArm 2
User x Disarm
Master Arm
Master Disarm
Master PartArm 1
Master PartArm 2
Master Disarm
Duress Disarm

System Event Messages:

AC Power Fail
System Low-bat
Remote Low-Bat
Keypad Low-Bat
Panic/PA
System Tamper
RF Jamming
Tel Line Error
V-Dialler Fail
V-Dialler SendOK
R-Manager Fail

REMOTE PHONE ACCESS AND CONTROL

The Remote Phone Access and Control facility, if enabled, allows you to dial into the system and monitor/control the basic alarm system functions.

The Control Panel will answer the call after the set number of rings and emit 3 beeps on the phone line.

Enter a User Access Code on the telephone keypad.

A valid User Access Code will be acknowledged with 1 long beep.

An incorrect code will be acknowledged by 2 short beeps.

If a User Access Code is not entered within 30 seconds or is entered incorrectly 3 times then the Control Panel will automatically disconnect the line.

Double Dial-In for Operation with an External Answer Phone:

If the Remote Access and Control feature is to be used and the system is operating in conjunction with an external Answer Phone then

1. Remote Phone Access and Control must be enabled.
2. The number of 'rings to answer' for the Control Panel must be greater than that of the external answerphone.

To access the Remote System Control facility the Control panel has a 'double dial-in' feature to enable the Control Panel to pick-up the phone call before the external answerphone cuts in. The 'double dial-in' procedure operates as follows:

1. Dial up the system and hang up after 1 or 2 rings.
2. Wait a few seconds and then redial up the system within 20 seconds, the system will answer the phone after 1 ring.
3. Enter the User Access Code as described above.

Remote Access and Control Functions:

The following functions may be access via the remote telephone. The system will acknowledge each signal with a single long beep over the phone.

Press **0** to interrogate the system status.

The status will be indicated by the following tones which are generated once.

1 long beep	system Disarmed
1 short beep	system Armed
2 short beeps	system Part-Armed (1 or 2)
3 short beeps	Alarm has occurred

Press **1** to initiate FULL ARM mode.

Press **2** to initiate Part-Arm 1 mode.

Press **3** to initiate Part-Arm 2 mode.

Press **4** to Disarm the system.

Press **5** to turn the Siren OFF.

Press **6** to turn the Siren ON.

Press **7** to activate listen in.

Press **8** to stop Listen-In.

Press **#** to end the session and disconnect the Control Panel line.

MONITORING (OPTIONAL)

REMOTE MANAGER

Refer to Remote Manager diagram on page 53.

If an alarm occurs and the Remote Manager dialler is enabled...

1. The Remote Manager dialler will activate after fixed 30s dialler delay has expired provided the system has not been disarmed in that period.
2. The first Remote Manager phone number will be dialled and the appropriate alarm signal transmitted.
3. If an acknowledgement signal is received from the Alarm Monitoring Service the dialler will stop and an 'R-Manager Send OK' message will be entered into the event log.

However...

4. If an acknowledgement signal is not received from the Alarm Monitoring Service the call will be ended and the next number will be dialled.

There will be a 10s pause between consecutive calls in the same sequence and a 30s pause between consecutive sequences.

5. If an acknowledgement signal is not received after each entered number has been called three times then the dialler will shut down and an 'R-Manager Fail' message will be entered into the event log.

Notes:

1. If system disarmed while dialler is operating the current call should be completed. After a further 10s the dialler will operate and send a Cancel signal to the alarm monitoring service using the same dialler process described above.
2. The same alarm event signal must not be re-transmitted until there has been at least 10 minutes of inactivity of that event. Alarm events on different zones are treated separately.

For example:

If an alarm event is triggered by a detector on zone 1, the AMS will be contacted with a "zone 1 intruder signal".

If another zone 1 alarm event occurs within 10 minutes the AMS will not be contacted with this event. The 10 minute period should restart at this point.

If a further zone 1 alarm event occurs after more than 10 minutes then this event will be transmitted to the AMS.

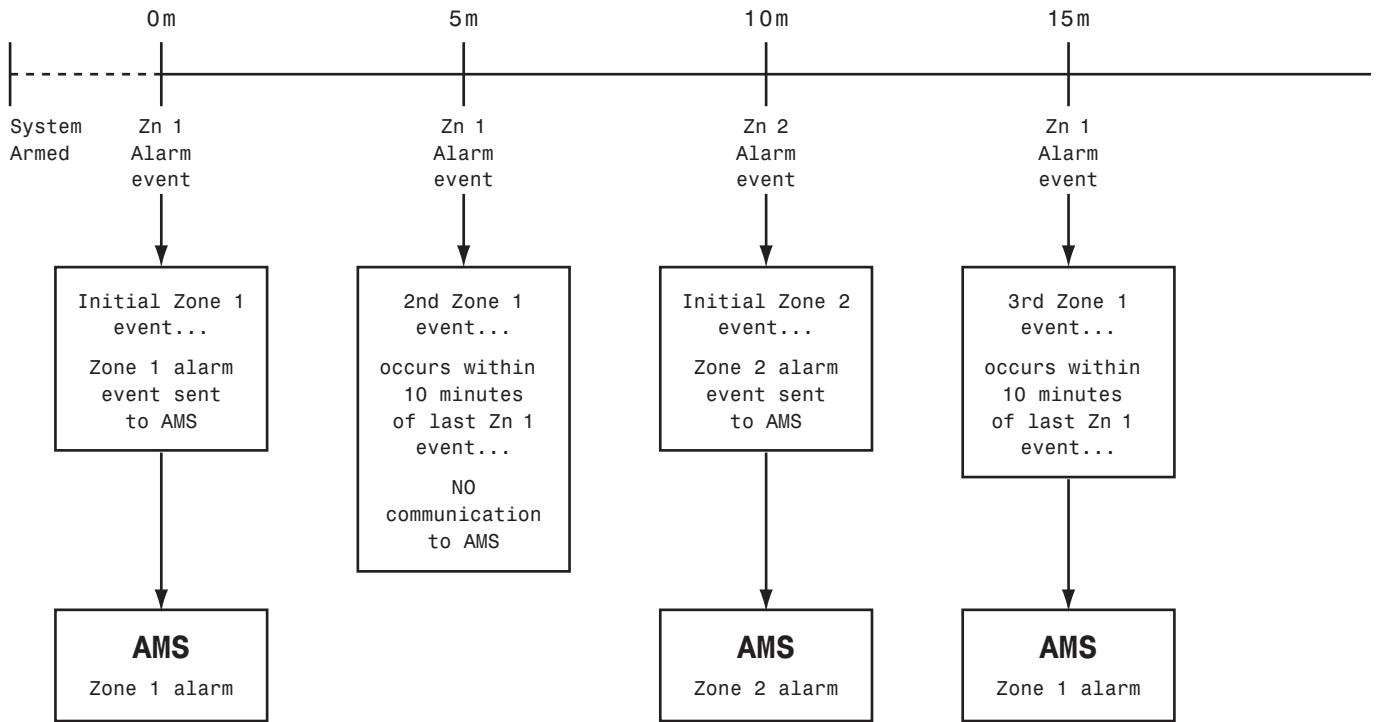

Remote Manager Diagram

VOICE DIALLER

If an alarm is triggered and the Voice dialler is activated then the first enabled phone number in the dialling sequence will be called and the recorded alarm message will be played. The recipient should acknowledge the message by pressing the * button on their telephone keypad to shut down the call sequence. If an acknowledgment signal is not received, then the next enabled number in the call sequence will be called. The dialler will continue calling each enabled number in turn until either all numbers in the sequence have been dialled or is cancelled by an acknowledged signal from a recipient.

The alarm and main messages will be repeated continuously for 60s. After 60s has elapsed the current message play cycle will be completed and then the call will be terminated. This ensures the message is not cut off part way through.

If an alarm occurs and the Voice Dialler is enabled...

1. The dialler will only activate after the fixed 30s dialler delay has expired provided the system has not been disarmed in that period.
2. Each entered phone number will be called in the order 1 - 2 - 3 - 4

If a number is not entered it will not be dialled.

3. 10s after the number is dialled the appropriate alarm message will be replayed followed immediately by the main message.

4. 10s delay before next entered number is dialled.
5. After all entered numbers have been dialled once. There will be a 30s delay before the next call sequence is started again from the first entered number.

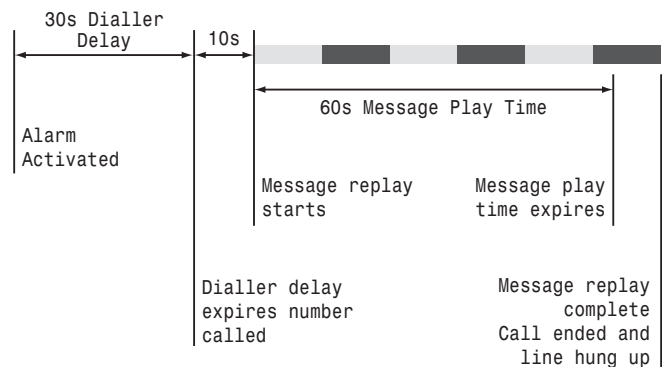

The dialler sequence can be stopped early by either...

- a. All numbers have been dialled three times
- b. The system is disarmed
- c. A call is acknowledged by the recipient pressing the  button on the telephone keypad.

Note: The line status warning will not operate if the voice dialler is disabled.

The 'Cancel/Abort' signal must only be sent if

- a. the dialler has successfully communicated the alarm event to the AMS, or
- b. the system is disarmed within 10 minutes of the last alarm event being successfully communicated to the AMS.

SIREN SERVICE / OPERATING MODE

In order to remove the Solar Siren from the wall to change the batteries, it is necessary to place the Siren into Service mode to prevent the Tamper switch on the Siren operating and triggering an Alarm. When you have completed any alterations to the system you must remember to switch the Siren back into Operating Mode.

The Siren can be switched between Service and Operating modes using either the Remote Control or Control Panel as follows:

Remote Control:



Press and hold the  button on the Remote Control for approx. 6 seconds.

Control Panel:

With the system in Standby with the Power LED ON:

Press  ,     , 
User Access Code

to enter Test Mode.

Use  and  buttons to scroll through the available options until 'Wirefree Siren Service ON/OFF' is displayed.

Press  .

The mode into which the Siren is switching will be indicated as follows:

Service Mode: The siren will produce two short beeps followed 1 second later by a single long beep. The Siren LEDs will flash together in conjunction with the beeps.

Operating Mode: The siren will produce a single long beep followed 1 second later by two short beeps. The Siren LEDs will flash together in conjunction with the beeps.

Press  to return to Standby mode.

BATTERY MONITORING

Low battery condition

All system devices continuously monitor their battery condition. When a low battery indicator is activated, the battery for that device should be replaced as soon as possible.

In addition if any PIR or Door/Window Detector has a low battery status it will be recorded by the Control Panel and a message stored in the Event Log.

In addition a low battery status on any PIR or Door/Window Detector will be recorded by the Control Panel and stored in the Event Log.

Note: Before removing the battery cover on any device to replace the battery ensure that the system is put into Test mode to avoid initiating a Full Alarm.

The low battery indication built into each system device is as follows:

Control Panel:

During a period of mains supply interruption the Control Panel will be powered by the rechargeable backup batteries.

Under normal battery conditions the Power LED on the panel will flash at 1 second intervals. However, under low battery conditions the Power LED will flash at 3 second intervals

Remote Control:

When the Remote Control is operated under low battery conditions the transmit LED will continue to flash after the button has been released.

Under normal battery conditions the LED will extinguish within 2 seconds of the button being released.

PIR Movement Detector:

Under low battery conditions the LED behind the detector lens will flash when movement is detected to indicate that the battery needs to be replaced.

Under normal battery conditions the LED does not illuminate unless the PIR Detector is in Walk Test mode.

Door/Window Detector:

When the Detector is activated, under low-battery conditions the Transmit LED will be illuminated for approx. 1 second as the door/window is opened.

Under normal battery conditions the LED does not illuminate as the Detector is operated, (unless the Detector is in Test Mode with the battery cover removed).

MAINTENANCE

Your Alarm System requires very little maintenance. However, a few simple tasks will ensure its continued reliability and operation.

SOLAR SIREN

1. It is recommended that the solar panel on the top of the siren housing should be cleaned at least twice a year, preferably in the Spring and Autumn, using a soft damp cloth. Do not use abrasive, solvent based or aerosol cleaners. Do not attempt to clean inside the unit or allow water to enter the unit.

This will ensure that the solar panel does not become affected by the build up of excessive dirt and receives all the available light.

2. The Siren should not be left for long periods with the batteries connected, unless the unit is able to receive sufficient light to maintain the battery charge. Failure to maintain charge to the unit will result in the rechargeable battery running unacceptably low. Should this occur, the unit must be recharged from a 7.5Vdc/100mA supply (e.g. from a mains adaptor power supply). When re-powering the Siren, fit a new 9V PP3 leak-proof Alkaline power-up battery to ensure that the Siren receives sufficient power until the solar panel can recharge the main battery.
3. The main rechargeable battery has a typical life of 3 - 4 years and needs no maintenance during this period, provided the battery is kept charged. The battery will be damaged if it is stored in a discharged state for long periods.

IMPORTANT: Before removing the Siren from the wall ensure that the Siren is first switched into Service Mode to prevent the Tamper switch operating and triggering an alarm.

First, place the Control Panel into Test Mode (see page 26) and then switch the Siren into Service Mode (see page 29).

The Siren must be switched back into Operating Mode, otherwise the system cannot be Armed.

CONTROL PANEL

The rechargeable batteries have a typical life in excess of 3 to 4 years and need no maintenance

during this period, provided they are kept charged. The batteries will be damaged if they are stored in a discharged state for long periods.

DETECTORS, REMOTE CONTROL AND KEYPAD

The Detectors and Remote Control require very little maintenance. The batteries should be replaced once a year or when a low battery status is indicated.

DUMMY SIREN

The batteries in the siren should be replaced once every year to ensure the siren continues to act as a visual deterrent during both the day and night.

BATTERIES

Note: Before removing the battery cover on any device to replace the battery ensure that the system is switched into Test Mode to avoid triggering an alarm.

The specifications for replacement batteries are:

Remote Control:
1 x 3V CR2032 Lithium Cell (or equivalent)
Door/Window Detector:
2 x 3V CR2032 Lithium Cells (or equivalent)
PIR Movement Detector:
1 x 9V PP3 Alkaline Battery
Keypad:
1 x 9V PP3 Alkaline Battery
Dummy Siren:
4 x 1.5V C Alkaline Batteries

Note: Rechargeable batteries should NOT be fitted to any detector.

DISPOSAL AND RECYCLING

Batteries and waste electrical products should not be disposed of with household waste. Please recycle where these facilities exist.

Check with your local authority or retailer for recycling advice.



The Rechargeable Batteries contain Sulphuric Acid – **DO NOT ATTEMPT TO OPEN THE CASING.**

ALARM RECORD

Complete the following information during installation for future reference, when adding to your system and to assist trouble shooting.

Zone	Detector Type(s)	Location	Type	Entry Delay	Chime	Arm	Part-Arm 1	Part-Arm 2
1								
2								
3								
4								
5								
6								
7								
8								
9								
10								
11								
12								
13								
14								
15								
16								
17								
18								
19								
20								
21								
22								
23								
24								
25								
26								
27								
28								
29								
30								
31								
32								
33								
34								
35								
36								

TROUBLE SHOOTING

Symptom / Recommendation

Control Unit not working - Power LED OFF or flashing.

1. Mains power failure - check if other electrical circuits are operable.
2. Check that mains adaptor is plugged in and socket is switched ON.
3. Check that DC jack plug from mains adaptor is connected in Control Panel.
4. Check fuse/MCB in Consumer Unit on the circuit serving the Control Panel.

Note: Before replacing any fuses or resetting the MCB, the cause of the failure should be investigated and rectified.

Control Unit “Low Battery” LED flashing.

1. Check all PIR, Door/Window, Remote, Keypad and Smoke Detectors for low battery indication, (i.e. LED behind detection lens flashes when movement detected). Renew batteries as required.

Control Unit not accepting User Access Code.

1. Pause between key depressions too long. Do not pause for more than 5 seconds between pressing keys.
2. Incorrect code entered. Press  before re-entering correct code.
3. Reset to factory defaults and reprogram system.

Detection Zone triggered (LED flashing) but no alarm is sounding.

1. Entry/Exit delay still running and not yet expired.
2. Alarm duration period has already expired and system has reset.
3. Alarm duration programmed to ‘no alarm’.

Siren and Indicator LEDs operating but no alarm at Control Panel.

1. Siren’s Tamper switch activated. Check security of Siren fixing to wall and adjustment of anti-tamper switch to ensure switch is fully depressed.

Siren not responding to Control Panel.

1. Ensure ‘ID Code’ of the Siren is learnt by the Control Panel.
2. Ensure main Siren configuration switch is set to SIREN.
3. Incorrect User Access Code being entered at Control Panel.
4. Ensure Siren is within effective radio range of Control Panel and equipment is not mounted close to metal objects.
5. Siren rechargeable battery discharged
 - a. Clean Solar Panel.
 - b. Check age of rechargeable battery - replace if at end of useful life.
 - c. Fit new initial power-up battery and re-power up Siren.

Full Alarm sounds when system has not been triggered by an intruder or is disarmed.

1. Tamper switch activation
 - a. Check all detector battery covers to ensure correctly fitted.
 - b. Check Control Panel and Siren are securely mounted to the wall and Tamper switch is closed.
2. Personal Attack Alarm operated from a Remote Control or Control Panel.
3. Jamming Detection circuit operated.

LED on Remote Control not illuminating, or is dim when unit is operated.

1. Ensure battery is fitted with correct polarity.
2. Ensure battery holder connections are making good contact with the battery.
3. Battery flat - replace battery.

PIR Detector false alarming.

1. Ensure that the detector is not pointing at a source of heat or a moving object.
2. Ensure that the detector is not mounted above a radiator or heater.
3. Ensure that the detector is not facing a window or in direct sunlight.
4. Ensure that the detector is not in a draughty area.
5. Sensitivity set too HIGH - reset to LOW sensitivity. (i.e. SW3 to down position).

PIR Detector not detecting a person's movement.

1. Ensure the battery clip is securely connected.
2. Ensure 'ID Code' of the detector is learnt for a particular zone.
3. Sensitivity set too LOW - reset to HIGH sensitivity. (i.e. SW3 to up position).
4. Ensure that detector is mounted the correct way up, (i.e. with detection window at the bottom).
5. Ensure that the detector is mounted at the correct height, (i.e. 2-2.5 metres).
6. Allow up to 3 minutes for detector to stabilize and become fully operational. Leave the area for this period.
7. Ensure detector is within effective radio range of the Control Panel and is not mounted close to metal objects which may interfere with Radio transmission.

PIR Detector LED flashes on detection of movement, (device in normal operation mode).

1. PIR still in Walk Test Mode for fixed 5 minutes after the PCB button was activated.
2. Low battery - replace battery.

Door/Window Detector not working.

1. Ensure that Magnet is correctly positioned in relation to Detector and that the gap between Magnet and Detector is less than 10mm.
2. Ensure batteries are fitted with correct polarity (correct way around).
3. Ensure battery holder connections are making good contact with the batteries and Circuit Board.
4. Ensure 'ID Code' of the detector is learnt for a particular zone.
5. If an additional wired Magnetic Contact is connected:
 - a. Check that both contacts are closed.
 - b. Check that additional contact is correctly wired and switch SW3 set to the INT./EXT. position.
6. Ensure detector is within effective radio range of Control Panel and is not mounted close to metal objects which may interfere with Radio transmission.

Door/Window Detector false alarming.

1. Ensure that magnet is correctly positioned in relation to detector.
2. Ensure that gap between magnet and detector is less than 10mm.
3. Tamper switch below battery cover is not depressed - check battery cover is fitted correctly and that fixing lugs are not broken.

LED on Door/Window Detector illuminating when door or window is opened.

1. Low battery - replace batteries.

Control Unit Not Contacting Remote Manager Service on Alarm.

1. Telephone line not connected or faulty - check phone line with another phone.
2. Dialer Mode incorrectly programmed.
3. Incorrect phone number for Remote Security Manager Service programmed.
4. Incorrect system ID number for Remote Security Manager Service programmed.
5. Remote Security Manager Service not commissioned or signed up.

Remote Phone Access and Control facility not functioning.

1. Telephone line not connected or faulty - check phone line with another phone.
2. Remote Access disabled.
3. Incorrect User Access Code entered.

Voice-Dialler Not Responding to Alarm.

1. Telephone line not connected or faulty - check phone line with another phone.
2. Incorrect phone numbers programmed.
3. Phone numbers disabled in dialling sequence.
4. Alarm messages not recorded.

Latch Key Not Responding when system Disarmed.

1. Telephone line not connected or faulty - check phone line with another phone.
2. Dialer Mode incorrectly programmed.
3. Latch Key disabled.
4. Latch Key set to Selected-Users and not enabled for User that is Disarming the system.
5. No Latch Key phone numbers programmed.

CUSTOMER HELPLINE

Most issues can be solved over the phone in a few minutes.

Please contact our Helpline Team on the number below for any installation and general advice regarding our products:

0844 736 9149

Lines open 9.00am to 5.00pm, Monday to Friday.
Calls charged at service providers national rate.

EXTENDING YOUR ALARM SYSTEM

The following additional accessories are available to enhance your system and provide further protection and a higher level of security where required.

ACCESSORIES



HW0

**Response Dummy Siren
Accessory**

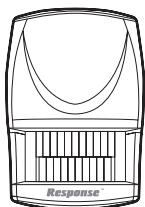

HW2

**Response PIR
Accessory**



HW3

**Response Remote
Control Accessory**

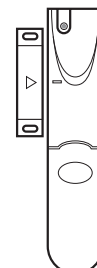

HW4

**Response Door/Window
Detector Accessory**

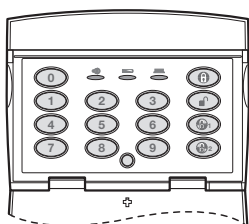

HW5

**Response Keypad
Accessory**

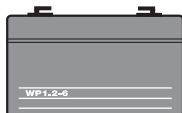

HW10

**Response 6V
Rechargeable Battery
Accessory**

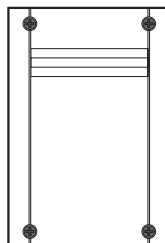

HW12

**Response External
Lighting Control
Accessory**

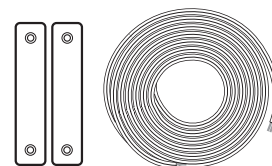

PW1

**Response Wired
Door/Window Contact
Accessory Pack**

GUARANTEE

Novar ED&S undertakes to replace or repair at its discretion goods (excluding non rechargeable batteries) should they become defective within 1 year solely as a result of faulty materials and workmanship.

Understandably if the product has not been installed, operated or maintained in accordance with the instructions, has not been used appropriately or if any attempt has been made to rectify, dismantle or alter the product in any way the guarantee will be invalidated.

The guarantee states Novar ED&S entire liability. It does not extend to cover consequential loss or damage or installation costs arising from the defective product. This guarantee does not in any way affect the statutory or other rights of a consumer and applies to products installed within UK and Eire only.

If an item develops a fault, the product must be returned to the point of sale with:

1. Proof of purchase.
2. A full description of the fault.
3. All relevant batteries (disconnected).

Response is a trademark of Novar ED&S.

COMPONENT SPECIFICATION

External Solar Siren

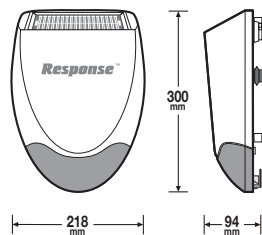

- RF operating frequency: 868MHz
- Sealed lead acid battery 6V/1.2Ahr
- Solar Panel 7.5V - Charge Rate typically 60mA
- Operation time in complete darkness - up to 25 days
- 95dB Piezo Siren
- 10 minutes alarm duration limiter (optional)
- Siren Disable (selectable)
- Rear anti-tamper protection
- Jamming Detection
- Audible confirmation

PIR Infra-Red Movement Detector

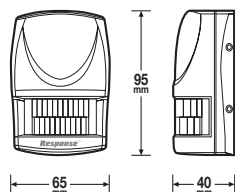

- RF operating frequency: 868MHz
- Range: 150 metre max.
- Detection range: 12 metres at 110°
- Walk test facility
- LOW/HIGH Detection Sensitivity
- Anti-tamper protected
- Corner or surface mount
- Battery life >1 year
- Low battery indicator

Magnetic Door/Window Detector(s)

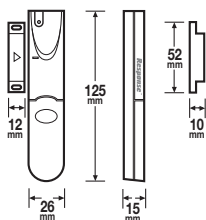

- RF operating frequency: 868MHz
- Range: 150 metre max.
- Test Mode
- Anti-tamper protection
- Facility to connect additional wired Magnetic Contact
- Battery life >1 year
- Low battery indicator

Control Panel

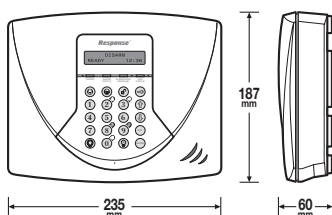

- RF operating frequency: 868MHz
- Range: 125 metre max.
- Battery back-up
- Detector Low-Battery Status Indication
- RF Jamming Detection
- 90dB Piezo Siren
- Dual front and rear anti-tamper
- 6 Users + Master User + Duress
- 4 digit User Access Code
- 6 Wireless Zones + 4 Wired zones
- 2 Part-Arm Facilities
- Independently programmable Entry and Exit delays
- Entry/Exit Delay Warning (selectable)
- Programmable Alarm Duration
- Quick Set
- Zone lockout
- Chime
- Event Log (99 events)
- Latch Key
- Remote Phone Access and Control System Control
- Listen-In facility.
- Front & Rear Anti-Tamper protection
- Personal Attack (PA) facility
- Telephone Voice Dialler
- Remote Security Manager interface
- Connections for Hardwired Siren

External Lighting Control (Optional)

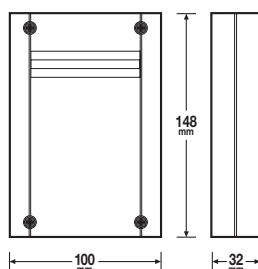

- Power supply: 230Vac~50Hz
- Load switching capacity
 - Tungsten Filament: 1200W
 - Tungsten Halogen: 1200W
 - Fluorescent: 250W
- Note: Not suitable for compact fluorescent lamps
- Protection: IP54
- Operating temperature: -20°C to +50°C
- Operating Frequency: 868MHz
- RF range: see transmitter device spec.
- No of linkable devices: 10

Remote Control (Optional)

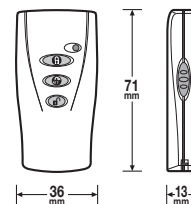

- RF operating frequency: 868MHz
- Range: 80 metre max.
- Personal Attack (PA) switch
- Operates all ARM, PART-ARM, and DISARM functions
- Transmission indicator
- Battery life >1 year
- Low battery indicator

Keypad (Optional)

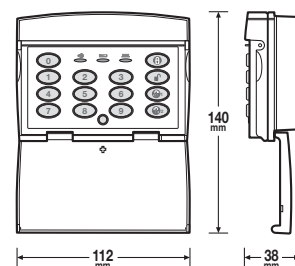

- RF operating frequency: 868MHz
- Range: 125 metre max.
- Changeable 4 digit User Access Code
- Anti-tamper protected
- Personal Attack (PA) facility
- Battery life >1 year
- Low battery indicator

RESEARCH & DEVELOPMENT

Our R & D Department is constantly developing new products. We practice a policy of continued improvement and reserve the right to change specifications without prior notice.

Novar Electrical Devices and Systems are Quality Assurance Registered to BS EN ISO9001 2000, by Asta.

CUSTOMER HELPLINE

Most issues can be solved over the phone in a few minutes.

Please contact our Helpline Team on the number below for any installation and general advice regarding our products:

0844 736 9149

Lines open 9.00am to 5.00pm, Monday to Friday. Calls charged at service providers national rate.



Novar Electrical Devices and Systems Limited. (A Honeywell Company)

The Arnold Centre, Paycocke Road, Basildon, Essex SS14 3EA. UK

www.friedland.co.uk

50042380Rev.A