

# SA1/SA2/SAC1

## Wirefree Alarm Systems



### Installation & Operating Manual

**III Response III**

# FOREWORD

The SA1, SA2 and SAC1 Wirefree Alarm Systems comply with the requirements of BS6799 Class 1 for Wireless Alarms. All components are designed and manufactured to provide a high standard of security protection and long, reliable service. In addition, the radio devices are tested and approved by the Radio Regulatory division of the Department of Trade and Industry (DTI) to ensure that they will not interfere with other radio equipment. No radio licence is required, however, the approved radio frequency is not protected from interference and may be withdrawn from use at any time subject to the DTI giving users an appropriate notice period.

These Alarm Systems are designed for ease of installation using only conventional domestic tools. However, it is essential that the installer reads and fully understands the advice and procedures contained in this manual and plans the system before proceeding with the installation.

During installation, it is important that the procedures described in this manual are followed in sequence.

**Note:** This manual covers the installation and operation of a number of different kit configurations. Instructions relating to components not included in your kit should be ignored.

**This manual should be retained in a safe place for future reference.**

## IMPORTANT

All components, with the exception of the External Solar Siren are suitable for mounting in dry interior locations only.

### Tools and Equipment Required:

- |                            |                    |
|----------------------------|--------------------|
| No.0 Philips Screwdriver   | Drill              |
| No.1 Philips Screwdriver   | Bradawl            |
| No.2 Philips Screwdriver   | Small Spirit Level |
| 5 & 6mm Masonry Drill Bits |                    |

## LOCAL AUTHORITY REGULATIONS

Depending on your location in the country, you may be required, by law, to notify the Local Authorities and Police of your new alarm installation.

Local Authority requirements differ from area to area, therefore, we recommend that you contact your Local Borough Environmental Officer to obtain full details of your area's requirements.

## SYSTEM SECURITY

This system has been designed to both detect intruders and act as a strong deterrent to would-be intruders.

Please remember that given adequate knowledge and time it is possible to overcome any alarm system and we therefore recommend that an Intruder Alarm is used in conjunction with good physical protection such as security window and door locks.

All units in the system are encoded to operate together using an 8 bit House Code which is configured by the user/installer to provide the system security code for your installation. The system House Code can be changed at any time by the user.

**IMPORTANT:** All units forming part of your alarm system must be set to the same House Code.

The system is operated from one or more Remote Control units and/or Keypads. Care should be taken to ensure that your Remote Control Unit(s) are not lost or the Keypad User Access code does not become known to other people as this will compromise the security of your system. In either event the system house code and/or User Access code should be changed as soon as possible.

In order to detect any attempts to jam the radio channel used for your alarm system, a special jamming detection function is incorporated into the Solar Siren. If this feature is enabled, and the radio channel is jammed continuously for 30 seconds, (when the system is armed), the Solar Siren will emit a series of rapid bleeps for 5 seconds as a pre-alarm. If the jamming continues for a further 10 seconds or more a full alarm condition will occur.

## SAFETY

Always follow the manufacturers advice when using power tools; steps, ladders etc. and wear suitable protective equipment (e.g. safety goggles) when drilling holes etc.

Before drilling holes in walls, check for hidden electricity cables and water pipes, the use of a cable/pipe locator maybe advisable if in doubt.

When using ladders, ensure that they are positioned on a firm stable surface at the correct angle and suitably secured before use.

The use of ear defenders is advisable when working in close proximity to the Siren due to the high sound level produced by this device.

# CONTENTS

	Page No.		Page No.
KIT CONTENTS	2	OPERATING INSTRUCTIONS	14
		System Service Mode	14
PLANNING AND EXTENDING YOUR WIREFREE SOLAR ALARM SYSTEM	3	System Operating Mode	14
		Arming The System	14
		Disarming The System	15
EXTERNAL SOLAR SIREN	4	Personal Attack (PA) Alarm	16
General Information	4	Battery Monitoring	16
Positioning the Solar Siren	4		
Installing the Solar Siren	4	MAINTENANCE	16
Configuring the Solar Siren	5		
Initial Power-up of the Solar Siren	6	ALARM RECORD	17
REMOTE CONTROL UNIT	6	TROUBLE SHOOTING	18
General Information	6		
Configuring the Remote Control	6	EXTENDING YOUR ALARM SYSTEM	20
Testing the Remote Control	7		
		COMPONENT SPECIFICATION	Back Cover
KEYPAD	7		
Positioning the Keypad	8		
Installing the Keypad	8		
Configuring the Keypad	8		
Testing the Keypad	9		
PASSIVE INFRA RED (PIR) MOVEMENT DETECTORS	9		
Positioning the PIR Movement Detectors	9		
Installing the PIR Movement Detectors	10		
Configuring the PIR Movement Detectors	11		
Testing the PIR Movement Detectors	11		
MAGNETIC CONTACT DETECTORS	12		
Positioning the Magnetic Contacts	12		
Installing the Magnetic Contacts	12		
Configuring the Magnetic Contacts	13		
Testing the Magnetic Contacts	13		
TESTING THE SYSTEM	14		
Initial Testing	14		
Testing An Installed System	14		

# KIT CONTENTS

The Alarm System should contain the following components.

Alarm System	SA1	SA2	SAC1
External Solar Siren Controller	1	1	1
Remote Control	1	1	1
PIR Movement Detectors	2	2	2
Magnetic Contact Set	0	2	2
Keypad	0	1	1

**Also included:**

- Installation & Operating Manual
- Fixing pack
- Batteries

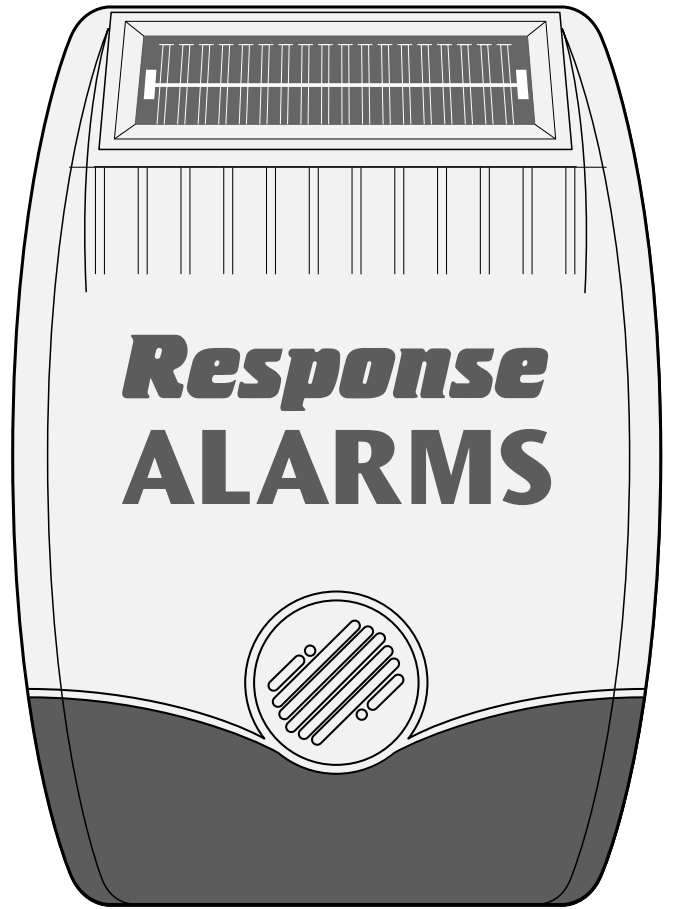

**External Solar Siren Controller**

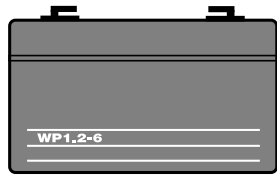

Sealed lead acid battery  
6V/1.2Ahr  
(for Solar Siren)

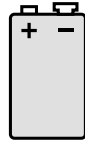

9V PP3 Alkaline  
battery  
(for Keypad and  
PIR Detector)



3V CR2032  
Lithium Cell  
(for Remote  
Control  
and Magnetic  
Contact Sets)

## IMPORTANT

Please check all items are present **BEFORE** breaking open the packaging clamshell. No claims for missing parts will be accepted unless the clamshell is unopened and intact.

## EXTENDING THE ALARM SYSTEM

The following additional accessories are available to enhance your system and provide further protection and a higher level of security where required.

**Component:**

**Product Code**

Two Magnetic Contact Sets  
and one Remote Control

SU1

Two Passive Infra-Red  
Movement Detectors

SU2

Two Remote Controls

SU3

Full details of these accessories are given on page 20.

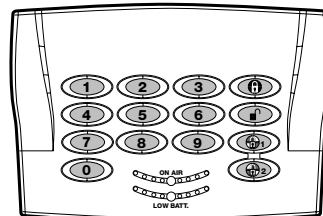

**Keypad**

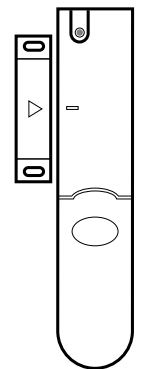

**Magnetic  
Contact Set**

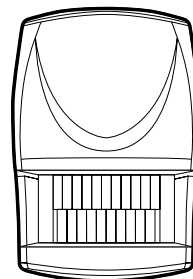

**PIR Movement  
Detector**

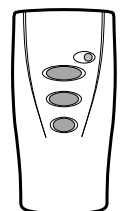

**Remote  
Control**

# PLANNING AND EXTENDING YOUR WIREFREE ALARM SYSTEM

The following example below shows typical property incorporating the suggested positions for the External Siren, Keypad, PIR and Magnetic Detectors for optimum

security. Use this as a guide for your installation in conjunction with the recommendations contained in this manual for planning your intruder alarm system.

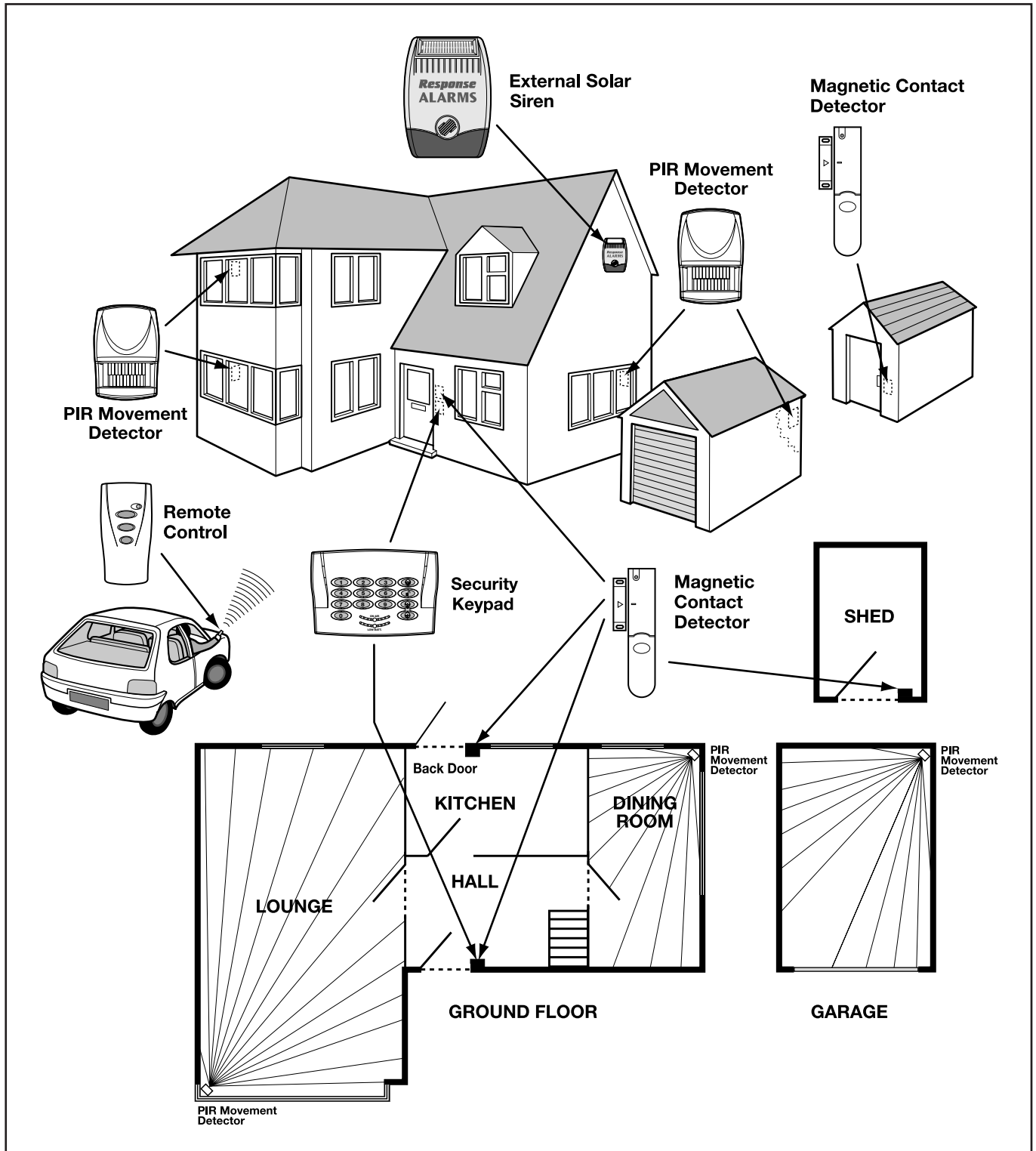

Before attempting to install your Alarm System it is important to study your security requirements and plan your installation.

The alarm system may be extended to provide even greater protection by fitting additional PIR Movement Detectors and Magnetic Contact Detectors as required.

# EXTERNAL SOLAR SIREN

The Siren and Solar Panel are all encapsulated within a tough polycarbonate housing. This housing provides full protection against adverse weather conditions. All electronic components are specially treated to ensure long, reliable, trouble free operation.

An LED Strobe unit is built into the siren to act as a visible deterrent/indication that the system is active. The Strobe LEDs will slowly and alternately flash whether the system is Armed or Disarmed. During an alarm condition the Strobe LEDs will flash rapidly.

An integral anti-tamper switch provides additional security protection to the Siren should any unauthorised attempt be made to interfere with and remove the siren cover.

The Siren is powered by a high capacity 6V/1.2Ahr rechargeable sealed lead acid battery. A Solar Panel mounted on the top of the housing charges the battery during daylight hours.

An 9V Alkaline PP3 battery is supplied in the External Siren to boost the initial power to the unit when the system is first activated until the Solar Panel charges the main battery.

The Siren unit incorporates the installations Jamming Detection system which will (if activated) generate an alarm if any attempt is made to continuously jam the radio channel used for the system.

## POSITIONING THE SOLAR SIREN

The Siren should be located as high as possible in a prominent position so that it can be easily seen and heard. The Siren should be mounted on a solid even surface so that the rear tamper switch is not activated when mounted. Ensure that the tamper switch does not fall into the recess between brick courses as this could prevent the switch from closing.

To provide the optimum amount of daylight to the Solar Panel, you should ideally mount the Solar Siren on a south facing wall. However, an easterly or westerly position will suffice.

Although the Solar Siren is designed to work on any aspect wall, for optimum performance you should refrain from siting the unit on a north facing wall, where possible.

Shadows cast by neighbouring walls, trees and roof overhangs should also be avoided. If the Siren is to be mounted below the eaves, it should be positioned a

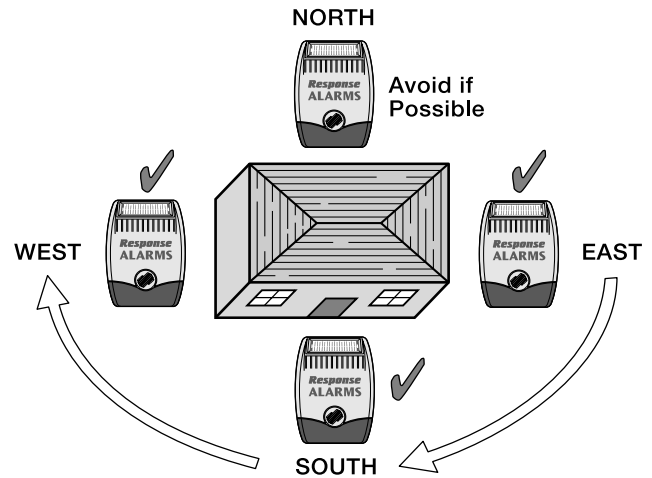

distance of at least twice the width of the eaves overhang below the eaves. Remember that in winter the sun is lower in the sky and you should avoid winter shadows where possible.

The External Solar Siren contains a sophisticated radio receiver. However, reception of radio signals can be affected by the presence of metallic objects within the vicinity of the Receiver. It is therefore important to mount the Solar Siren a minimum distance of 1m away from any external or internal metalwork, (i.e. drainpipes, gutters, radiators, mirrors etc).

It is recommended that you check the suitability of your chosen location for the Solar Siren by temporarily fitting it to the external wall. Using the Remote Control, (as described below) power up the Siren and check that you can operate the Siren from in and around the property, and from all locations where you plan to install detectors.

## INSTALLING THE SOLAR SIREN

1. Remove the fixing screw from the bottom edge of the Siren housing and carefully hinge off the front cover. All electronic components are housed within the front cover.
2. Hold the mounting plate in position and mark the positions of the four mounting holes. A spirit level placed on the casing will ensure a perfect level. Drill four 6mm holes and fit the wall plugs.
3. Fit two 30mm fixing screws in the top holes leaving approximately 10mm of the screw protruding.
4. Fit the top keyhole slots of the mounting plate over the screw heads. Remove the mounting plate and adjust the screws until they form a neat fit with the mounting plate with minimal movement.
5. Secure the mounting plate in position using two 25mm fixing screws in the bottom fixing holes.

# CONFIGURING THE SOLAR SIREN

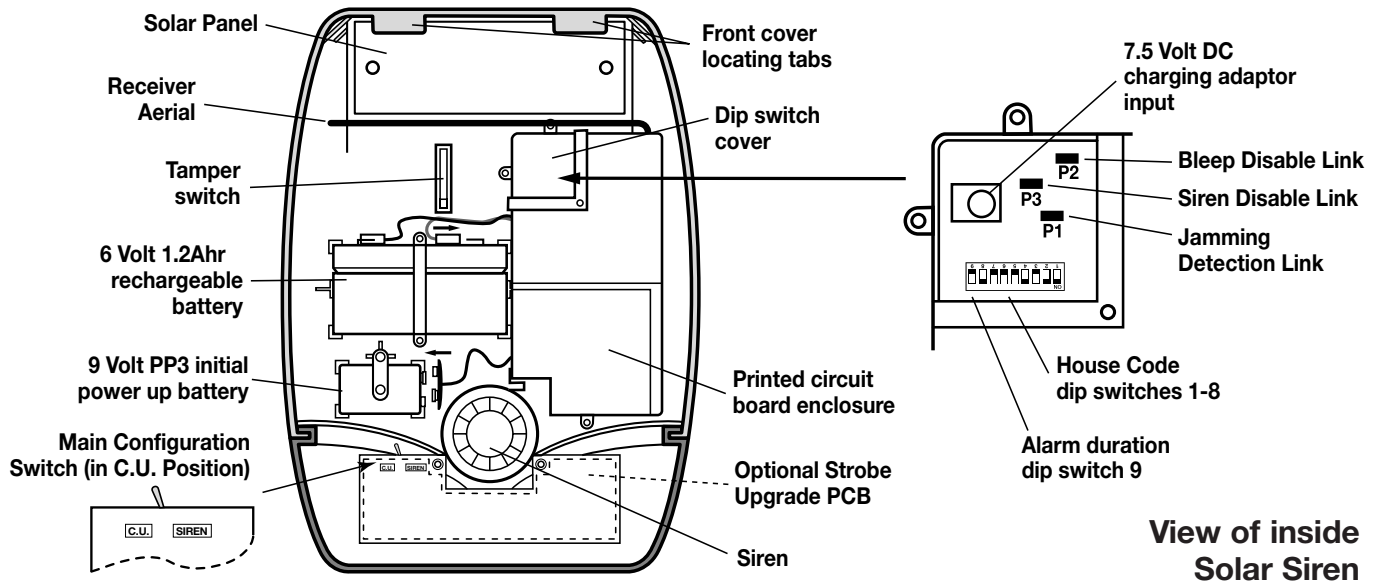

Ensure that the Solar Siren main configuration switch on the LED strobe board is set to "C.U." for use with this alarm system.

Undo the 3 screws holding the DIP Switch Cover in place and remove the cover.

## HOUSE CODE

Under the cover you will find a series of 9 DIP switches.

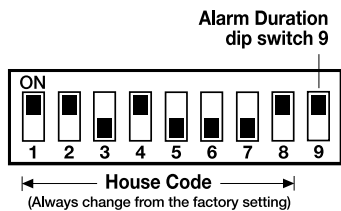

Select and record a random combination of 'ON' and 'OFF' positions for DIP switches 1 - 8. This will be the system House Code that will enable all devices on the system to communicate with the Solar Siren.

**IMPORTANT:** The house code for your system should be changed from the factory default settings.

**Note:** When the Solar Siren is viewed as shown above (Solar panel at top) the DIP switches are 'upside down'.

## ALARM DURATION

This is the length of time that the alarm will sound for, following activation. The Alarm duration can be set for either 1 or 3 minutes using DIP switch 9 as follows:

- ON = 3 minutes
- OFF = 1 minute

If accidentally triggered, the alarm can be stopped at any time using the Remote Control.

## BEEP DISABLE

The Solar Siren will acknowledge signals from the Remote Control by beeping. It is possible to disable the beeps if required by removing the jumper link P2 on the circuit board.

## SIREN DISABLE

If for any reason you need to disable the Siren, remove jumper link P3 on the circuit board. This will prevent the Siren from sounding during an alarm condition. However, the Siren will still beep to acknowledge signals from the Remote Control, (provided the beep feature is not disabled).

## JAMMING DETECTION DISABLE

To enable the Jamming Detect feature fit the jumper link taped to the cover of the Siren control unit across link pins P1 on the circuit board.

**Note:** The Jamming Detection circuit is designed to permanently scan for jamming signals. However, it is possible that it may detect other local radio interference operating legally or illegally on the same frequency. If it is planned to operate the jamming detection feature we recommend that the system is monitored for false jamming alarms for at least 2 weeks prior to leaving the Jamming Detection function permanently enabled

Once you have completed setting your House Code and system features, refit the DIP switch cover and replace the three cover fixing screws. Do not over tighten the screw as this could damage the thread.

## INITIAL POWER-UP OF THE SOLAR SIREN

1. Connect the 9V PP3 initial power battery to the battery clip.

Connect the rechargeable battery to the charging leads. Connect the Red lead to the Red (+ve) terminal and the Black lead to the Black (-ve) terminal.

**Note:** Once the batteries have been connected, the unit will be operational and it is important that the solar panel receives sufficient light to maintain the battery charge. The unit should not be repeatedly set into alarm during installation/testing, as this will rapidly drain the battery.

2. Press the anti tamper switch, the LEDs will flash together to indicate that the unit is operational.
3. Hinge the front cover locating tabs over the top edge of the back plate and carefully push the base of the siren cover into place. Secure the Siren cover in place by refitting the fixing screw in the bottom edge of the cover. Do not over tighten the screw as this could damage the thread.

**IMPORTANT:** Ensure that the rear tamper switch is closed when you fit the siren cover to the back-plate (i.e. listen for the switch to click). If the switch does not close this will prevent the Solar Siren from operating correctly. If necessary, remove the siren cover again and adjust the screw on the back-plate tamper plunger to ensure the switch closes when the Siren is secured in position.

4. If fitted remove the protective film covering the Solar Panel.
5. The fitting of the Solar Siren is now complete and the unit is automatically in Service Mode.

While in Service Mode the Solar Siren will not acknowledge any signals from Detectors, Personal Attack Buttons, Tamper Switches etc. Service Mode is controlled from the Remote Control - refer to page 14 for details.

## REMOTE CONTROL UNIT

The Remote Control Unit is used to Arm and Disarm the system. The Remote Control can arm the system in either Instant or Delay modes.

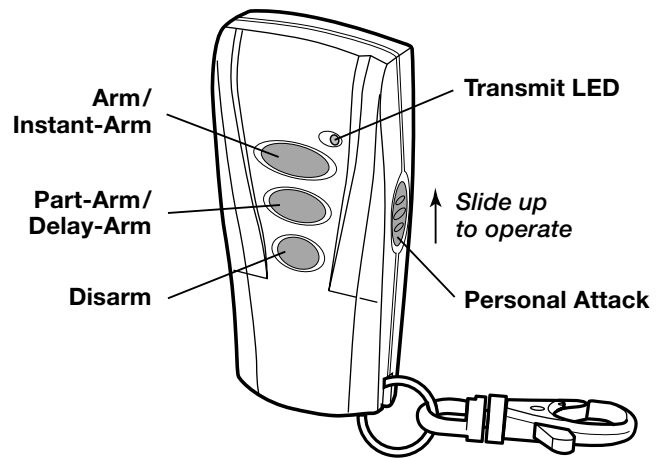

The Remote Control Unit also incorporates a Personal Attack (PA) switch. Activating the PA switch on the side of the Remote Control will immediately initiate a Full Alarm condition whether the system is Armed or Disarmed. The alarm can be cancelled by pressing the 'DISARM' button on the Remote Control.

Any number of Remote Control Units can be used with your system, providing they are all coded with the system House Code.

The Remote Control is powered by a CR2032 type Lithium cell which under normal conditions will have an expected life in excess of 1 year. Under normal battery conditions the LED on the Remote control will only illuminate when a button is pressed. However, under low-battery conditions this LED will continue to flash after the button has been released. When this occurs the batteries should be replaced as soon as possible.

## CONFIGURING THE REMOTE CONTROL

1. Remove the rear cover by undoing the small screw on the rear of the Remote Control.
2. Located above the battery cover is a row of 8 DIP switches. These switches set the House Code for the Remote Control and must be set to the same ON/OFF combination as the House Code DIP switches in the Solar Siren.
3. Ensure that the jumper link located immediately below the House Code DIP switches is removed for use with this alarm system.
4. Insert the battery under the clip ensuring that the +ve terminal faces upwards away from the PCB.

- Replace the rear cover and fixing screw.

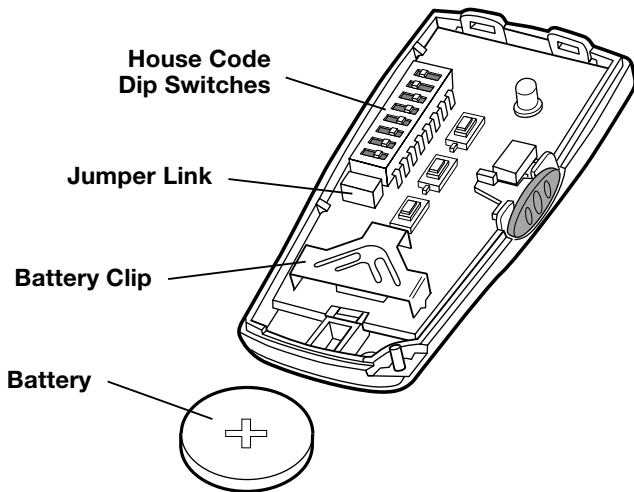

## TESTING THE REMOTE CONTROL

- Stand within view of the Solar Siren, press and hold the 'INSTANT-ARM' button on the Remote Control for approximately 10 seconds until the Solar Siren acknowledges the signal by emitting one long Beep (unless Beep Disable has been set). This operation takes the Solar Siren out of Service mode and into Operating mode (in a Disarmed state).

**Note:** The 'INSTANT-ARM' button should be released during or immediately after the long beep, otherwise the system will switch into an Armed state.

If the Siren continuously sounds at this point it is likely that the anti tamper switch on the Siren has not been closed. Press the 'DISARM' button on the Remote Control to switch OFF the Siren. Remove the Siren from the mounting plate and adjust the screw on the tamper knob to ensure the switch closes when the Siren is secured in position.

- Arm the system in Instant mode by pressing the 'INSTANT-ARM' button. The Siren will acknowledge the signal by beeping once.
- Disarm the system by pressing the 'DISARM' button. The Siren will acknowledge the signal by beeping twice.
- Arm the system in Delay mode by pressing the 'DELAY-ARM' button. The Siren will acknowledge the signal by beeping once and then again after the 15s entry/exit delay has expired.

- Disarm the system by pressing the 'DISARM' button. The Siren will acknowledge the signal by beeping twice.
- To test the range of the Solar Siren and Remote Control, press the 'DISARM' button on the Remote Control from in and around the property and from all locations where you plan to install detectors, check that the Siren acknowledges the signals from the Remote Control by beeping twice each time the 'DISARM' button is pressed.
- When you have finished testing the Remote Control, return the system to Service mode by pressing and holding the 'DISARM' button on the Remote Control for approximately 10 seconds until the Solar Siren acknowledges the signal by emitting one long Beep (unless Beep Disable has been set)

## IMPORTANT

Ensure that the system is in Service mode before proceeding with the installation, otherwise a full alarm condition could occur.

## KEYPAD

The Remote Keypad is used to control the Solar Siren and to Arm and Disarm the system by entering a four digit User Access Code. The Keypad can arm the system in either Instant or Delay modes.

The Keypad incorporates an anti tamper protection facility. Any attempt to open the casing of the Keypad will immediately initiate a Full Alarm condition even if the system is disarmed, (unless the system is in Service mode). In addition if a sequence of more than 16 incorrect key presses is entered the keypad will be disabled for the next 15s, (except the tamper protection function).

The Keypad also incorporates a Personal Attack (PA) facility which will immediately initiate a Full Alarm condition when activated.

The Keypad is powered by a PP3 Alkaline battery which under normal conditions will have an expected life in excess of 2 years. When the battery level drops and the "LOW BATT" LED on the front of the Keypad will flash. When this occurs the batteries should be replaced as soon as possible.

## POSITIONING THE KEYPAD

The Keypad is suitable for mounting in dry interior locations only.

The Keypad should be located within a protected area so that an intruder cannot reach the Keypad without opening a protected door or passing through an area protected by a PIR Movement Detector. The Keypad should be mounted in a position close to the main entrance door so that the user access code can be entered and the alarm system shut down within the 15s entry time period.

Ensure that the position selected for the Keypad is within effective range of the Siren, (refer to "Testing of Remote Control").

**Note:** DO NOT fix the Keypad to metalwork or locate the unit within 1m of metalwork (i.e. radiators, water pipes, etc) as this could affect the radio range of the Keypad.

## INSTALLING THE KEYPAD

Ensure that the solar siren is in service mode.

1. Undo and remove the fixing screw from the bottom edge of the Keypad and remove the wall mounting plate.
2. Using the mounting plate as a template, mark the positions of the two fixing holes on the wall. A small spirit level will ensure a perfect level.
3. Fix the mounting plate to the wall using the two 18mm No.4 screws and 25mm wall plugs as required, (a 5mm hole will be required for the wall plugs). Do not over-tighten the fixing screws as this may distort or damage the mounting plate.
4. Undo and remove the four fixing screws in the rear of the Keypad and remove the rear cover.
5. Connect the PP3 Alkaline battery to the battery clip.
6. Configure the Keypad as described below and then replace the rear cover and fixing screws.
7. Refit and secure the Keypad onto the wall mounting plate. Do not over-tighten the fixing screws.

**Note:** The Keypad is supplied with a default User Access Code of: 1 2 3 4. However, for security reasons, it is recommended that this code is changed to another four digit number which only you and other users of the system know.

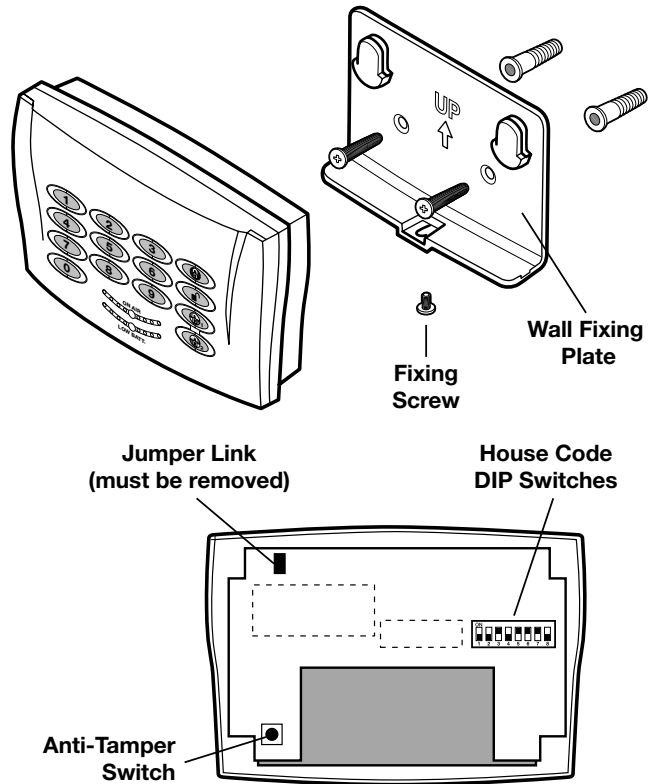











## CONFIGURING THE KEYPAD

1. Located above the battery clip is a row of 8 DIP switches 1 - 8. These switches set the House Code for the Remote Control and must be set to the same ON/OFF combination as the DIP switches in the Solar Siren.
2. Ensure that the jumper link located in the top left corner of the PCB (shown in the above diagram) is removed for use with this alarm system.

## CHANGING THE USER ACCESS CODE

When using the Keypad the keys must be pressed firmly and within five seconds of each other. If you make a mistake, wait five seconds and recommence programming from the beginning of the sequence.

To change the User Access Code, press the following keys in sequence:

1. Press 
2. Enter default (or current) User Access code:  
   
3. Press  - The 'on-air' LED will flash twice
4. Enter new User Access code:  
   
5. Press  - the 'on-air' LED will flash three times to confirm the setting has been accepted. If the light

does not flash, wait five seconds and re-enter the programming sequence from the beginning.

## TESTING THE KEYPAD

1. Put the system into Operating mode by pressing and holding the 'INSTANT-ARM' button on the Remote Control for approximately 10 seconds until the Siren acknowledges the signal by emitting one long Beep (unless Beep Disable has been set).



The Siren will acknowledge the signal by beeping once.

3. Disarm the system entering the User Access code followed by the 'DISARM' button on the Keypad.



The Siren will acknowledge the signal by beeping twice.

4. Arm the system in Delay mode by entering the User Access code followed by the either 'DELAY-ARM' buttons on the Keypad.



The Siren will acknowledge the signal by beeping once and then again after the 15s entry delay.

5. Disarm the system entering the User Access code followed by the 'DISARM' button on the Keypad.



The Siren will acknowledge the signal by beeping twice.

6. Activate the Personal Attack (PA) alarm by pressing and holding both 'DELAY-ARM' buttons on the Keypad.



After approximately 2 seconds a Full Alarm condition will be initiated.

7. Immediately Disarm the system entering the User Access code followed by the 'DISARM' button on the Keypad.



The Siren will stop sounding.

8. When you have finished testing the Keypad, return the system to Service mode by pressing and holding the 'DISARM' button on the Remote Control for approximately 10 seconds until the Siren acknowledges the signal by emitting one long beep (unless Beep Disable has been set).

## PASSIVE INFRA RED (PIR) MOVEMENT DETECTORS

PIR detectors are designed to detect movement in a protected area by detecting changes in infra-red radiation levels caused for example when a person moves within or across the devices field of vision. If movement is detected an alarm signal will be generated, (if the system is armed).

**Note:** PIR detectors will also detect animals, so ensure that pets are not permitted access to areas fitted with Passive Infra Red Movement Detectors when the system is armed.

Any number of PIR Movement Detectors can be used with your system, providing they are all coded with the system House Code and are mounted within effective radio range of the Solar Siren.

The PIR Detector is powered by a PP3 Alkaline battery which under normal conditions will have an expected life in excess of 1 year. When the battery level drops, with the PIR in normal operation mode and the battery cover fitted, the LED behind the detection window will flash. When this occurs the batteries should be replaced as soon as possible.

## POSITIONING THE PIR MOVEMENT DETECTORS

The recommended position for a PIR Movement Detector is in the corner of a room mounted at a height between 2 and 2.5m. At this height, the detector will have a maximum range of up to 12m with a field of view of 110°. The Position of the PCB inside the PIR can be set to 5 different positions to adjust the range and height of the detection pattern created by the PIR. Setting the PCB in position 3 will reduce the range to approximately 9m, with position 1 providing a range of approximately 6m. The recommended position for the PCB is in position 5. (see diagram overpage).

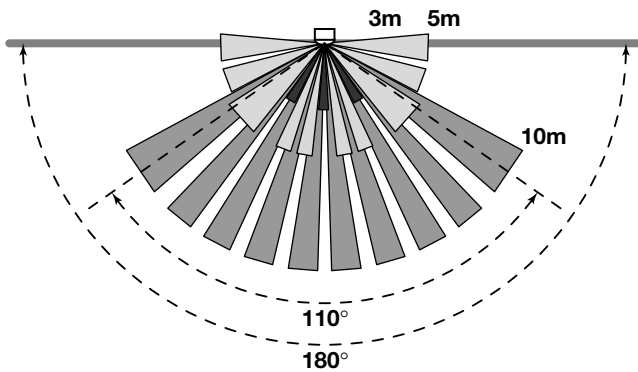
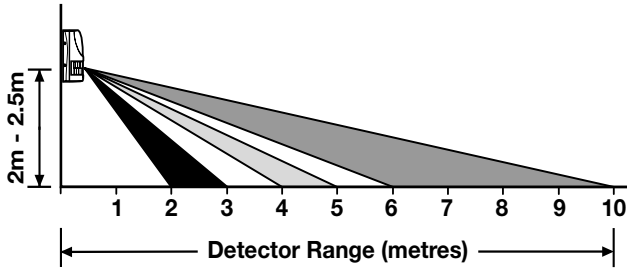

### Detection Zone Pattern for PCB in position 5

When considering and deciding upon the mounting position for the detector the following points should be considered to ensure trouble free operation:

1. Do not position the detector facing a window or where it is exposed to or facing direct sunlight. PIR Movement Detectors are not suitable for use in conservatories.
2. Do not position the detector where it is exposed to draughts
3. Do not position the detector directly above a heat source, (e.g. fire, radiator, boiler, etc).
4. Where possible, mount the detector in the corner of the room so that the logical path of an intruder would cut across the fan detection pattern. PIR detectors respond more effectively to movement across the device than to movement directly towards it
5. Do not position the detector in a position where it is subject to excessive vibration

Ensure that the position selected for the PIR detector is within effective range of the Siren, (refer to "Testing of Remote Control").

**Note:** When the system is Armed, household pets should not be allowed into an area protected by a PIR Detector as their movement could trigger the PIR and initiate an alarm.

**Note:** DO NOT fix the detector to metalwork or locate the unit within 1m of metalwork (i.e. radiators, water pipes, etc) as this could affect the radio range of the Keypad.

## INSTALLING THE PIR MOVEMENT DETECTORS

Ensure that the system is in service mode.

1. Undo and remove the fixing screw from the bottom edge of the PIR. Carefully pull the bottom edge of the detector away from the rear cover and then slide down to release the top clips.
2. Carefully drill out the required mounting holes in the rear cover using 3mm drill according to whether the unit is being mounted in a corner or against a flat wall.

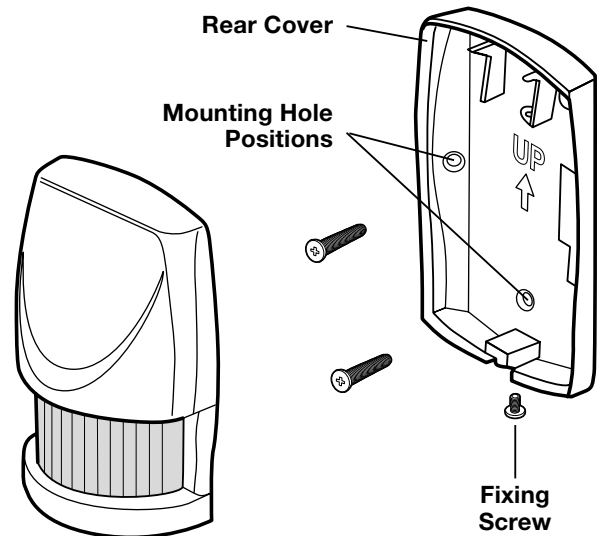

3. Hold the rear cover in position against the wall and mark the positions of the fixing holes.
4. Fix the rear cover to the wall using the two 18mm No.4 screws and 25mm wall plugs, (a 5mm hole will be required for the wall plugs). Do not over-tighten the fixing screws as this may distort or damage the cover.
5. Configure the PIR detector as described below. Remember that on initial installation the device needs to be tested and should therefore be configured in Walk Test Mode.
6. Check that the detector PCB is located and set in the correct position to provide the required detection range.

To adjust the PCB position simply slide it up and down ensuring that the location legs are aligned with the required position number marked on the board.

- To refit the PIR detector to the rear cover, offer the detector up to the wall bracket and locate the clips in the top edge into the rear cover. Push the lower edge of the detector into place and refit the fixing screw in the bottom edge of the PIR to secure in position. Do not over-tighten the fixing screws as this may damage the casing.

## CONFIGURING THE PIR MOVEMENT DETECTORS

Located on the PCB of the PIR Detector are two blocks of DIP switches (labelled SW2 and SW3).

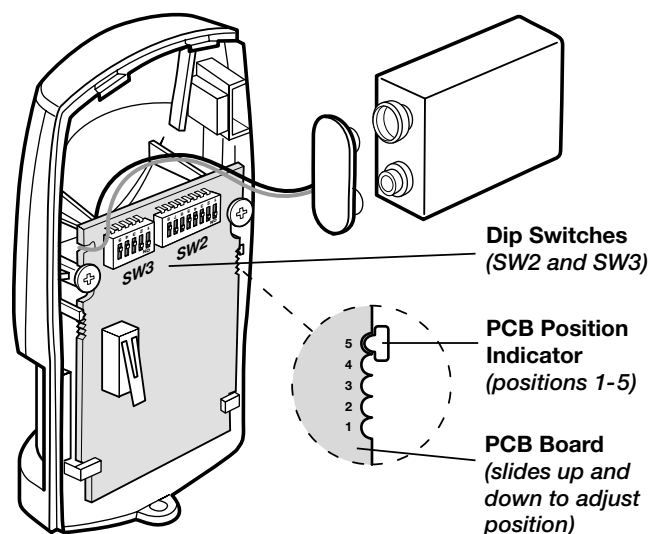

- DIP switches 1 - 8 of SW2 are used to set the House Code for the PIR Detector and must be set to the same ON/OFF combination as the House Code DIP switches in the Solar Siren.
- DIP Switches 1-3 of SW3 must be set as follows for use with this alarm system:

DIP 1	DIP 2	DIP 3
ON	ON	OFF

- DIP switch 4 of SW3 is used to configure the PIR Detector for walk test mode, which allows the operation of the detector to be checked during installation without initiating an alarm.

ON	Walk Test mode
OFF	Normal operation

**Note:** On initial installation the detector should be configured into Walk-Test mode ready for testing.

- The PIR Detector incorporates an anti-false alarm feature designed to compensate for situations where the detector may be affected by environmental changes, (e.g. insects, air temperature, etc). This feature is called "Pulse Count" and may be selected for 1 or 2 pulse detection.

The recommended setting is for 1 pulse detection. However, in cases of extreme environmental problems or if unattributable false alarms are experienced, it may be necessary to select 2 pulse detection.

To select the required pulse count set DIP switch 5 of SW3 as follows:

ON	1 pulse detection
OFF	2 pulse detection

**Note:** The higher the Pulse Count the more movement will be necessary before the PIR detector will trigger the alarm.

- Connect the PP3 Alkaline battery to the battery clip.

**Note:** When the 9V Alkaline battery is connected the LED behind the lens will rapidly flash for approximately 2-3 minutes until the PIR has warmed-up and stabilised. The LED will then stop flashing and turn OFF.

## TESTING THE PIR MOVEMENT DETECTORS

**Ensure that the system is in service mode.**

- With the PIR detector configured in Walk Test mode and mounted in position on the wall, allow 2-3 minutes for the detector to stabilise before commencing the Walk test.
- Walk into and move slowly around the protected area, each time the detector senses movement the LED behind the lens will flash.

**Note:** In normal operation, with the battery cover on, the detector LED will not flash on movement detection.

If necessary re-adjust the detection pattern by adjusting the mounting position of the PCB within the PIR housing.

- Reconfigure the PIR Detector into Normal operation mode and refit in position.

**Note:** When the detector is fully installed i.e. battery cover is refitted; the unit will not detect movement for approximately 45 seconds after each activation. (This feature is present to conserve battery power and maximise the battery life).

## MAGNETIC CONTACT DETECTOR(S)

The Magnetic Contact Set comprises two parts; a Detector and a Magnet. They are designed to be fitted to either doors or windows with the Magnet screwed to the moving/opening part and the Contact screwed to the fixed door or window frame.

When the protected door or window is closed the Detector Contact Switch is held closed by the Magnetic field from the Magnet. Opening the protected door or window will remove the magnetic field and allow the Contact Detector Switch to open generating an alarm signal, (if the system is armed).

The Magnetic Contact Detector has the facility to connect an additional wired Magnetic Contact. This must be of a normally closed contact type with the contact being opened in order to generate an alarm condition.

Any number of Magnetic Contact Detectors can be used with the system, providing they are all coded with the system House Code and are mounted within effective radio range of the Solar Siren.

The Magnetic Contact Detector is powered by two CR2032 type Lithium cells which under normal conditions will have an expected life in excess of 1 year. Under normal battery conditions the LED on the Detector will not illuminate when the Detector is triggered, (unless in test mode). However, under low-battery conditions this LED will be illuminated for approx 1s when the detector is triggered. When this occurs the batteries should be replaced as soon as possible.

### POSITIONING THE MAGNETIC CONTACTS

The Magnetic Contact Detector is suitable for mounting in dry interior locations only.

Decide which doors and windows are to be protected by fitting Magnetic Contact Detectors, (usually the front and back doors as a minimum will have Magnetic Contact Detectors fitted). However additional detectors may be fitted where required to other more vulnerable doors or windows, (e.g. garage, patio/conservatory doors etc).

Ensure that the position selected for the Magnetic Contact detector is within effective range of the Siren, (refer to "Testing of Remote Control").

**Note:** Take care when fixing the Detector to a metal frame, or mounting within 1m of metalwork (i.e. radiators, water pipes, etc) as this could affect the radio range of the device. If required, it may be necessary (under exceptional circumstances) to space the Magnet and Detector away from the metal surface using a plastic or wooden spacer to achieve the necessary radio range.

### INSTALLING THE MAGNETIC CONTACTS

**Ensure that the system is in service mode.**

- Remove the battery cover by sliding and lifting it off. (DO NOT use a screw driver to lever off).
- Remove the battery holder by carefully tilting up the end and pulling the connector off of the printed circuit board.

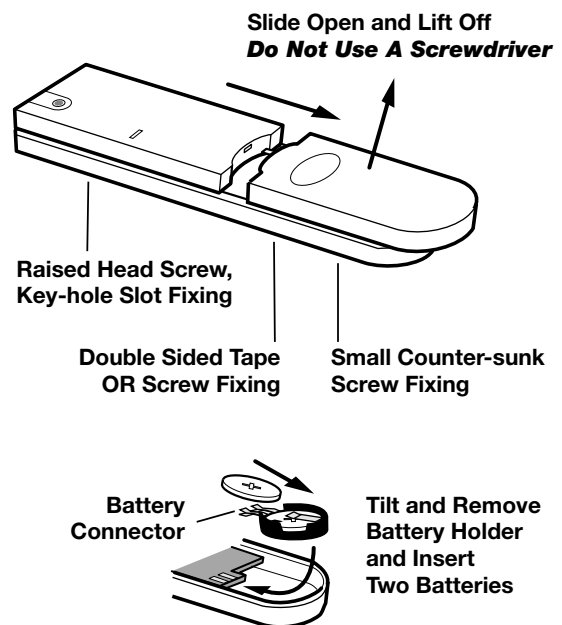

- Mount the Detector to the fixed part of the frame along the opening edge opposite the hinges using either the double sided adhesive tape or screws provided.

When fixing the Detector with screws the top of the Detector is secured with a keyhole slot over the head of the smaller pan head screw. The bottom of the Detector is secured using the 12mm counter-sunk head screw fitted within the battery compartment. Carefully drill out the centre of the fixing screw hole in the battery compartment using a 3mm drill. Do not over-tighten the fixing screws as this may distort or damage the casing.

- Fit the Magnet to the moving part of the door/window opposite the Detector using the two 15mm fixing screws. Ensuring that the parallel gap between the Magnet and Detector is than 10mm and that the arrow on the Magnet is pointing towards and aligned with the mark on the top section on the Detector.

*(Ensure back surfaces are flush)*

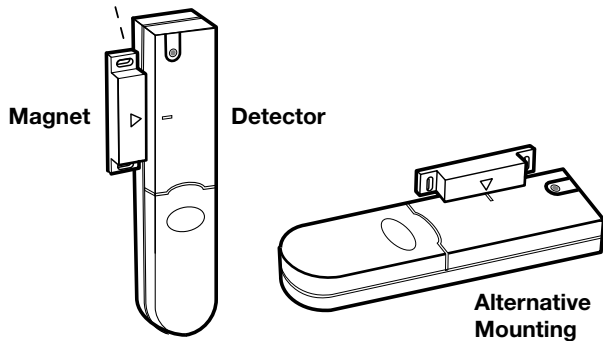

- If an additional wired Magnetic Contact is required, this should be wired to the terminal block provided in the battery compartment. The wired contact should be connected using two core (24AWG) wire of maximum length 1.5m.

A cable entry cut-out is provided beside the terminal block in the battery cover.

- Configure the Detector as described below.
- Slide the batteries supplied into the battery holder, ensuring that the positive (+) side is uppermost on each battery as it is installed.
- Carefully refit the battery holder onto the Detector ensuring that the spring connectors slide onto either side of the circuit board.

## CONFIGURING THE MAGNETIC CONTACTS

- Located in the battery compartment is a row of 11 DIP switches.
- DIP switches 1-8 are used to set the House Code for the Magnetic Contact Detector and must be set

to the same ON/OFF combination as the House Code DIP switches in the Solar Siren.

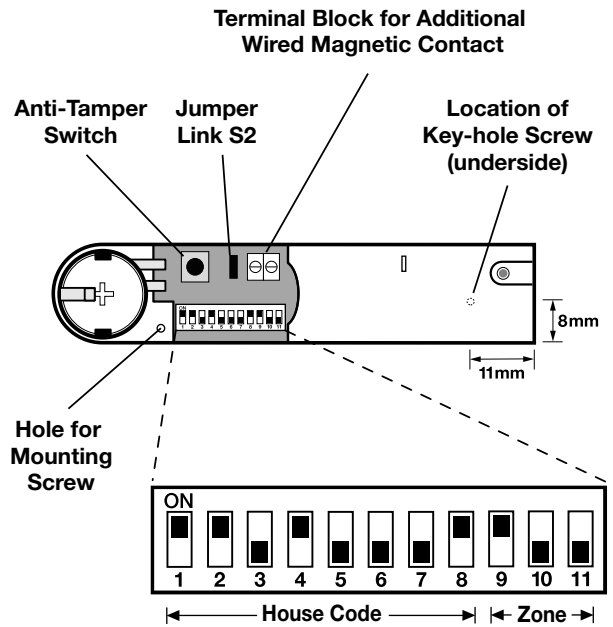

- DIP Switches 9-11 must be set as follows for use with this alarm system:

DIP 9	DIP 10	DIP 11
ON	ON	OFF

- If an additional wired contact is connected to the Detector, remove the jumper link S2 on the PCB.

**IMPORTANT:** If an additional wired contact is not connected then jumper link SW2 must be fitted for the detector to operate correctly.

## TESTING THE MAGNETIC CONTACTS

Ensure that the system is in service mode.

- Remove the battery cover from the Detector.  
The LED on the Detector will illuminate for approx 1s as the battery cover is removed to indicate that the tamper switch has been activated.
- Open the door/window to remove the magnet from the Detector. As the magnet is moved away from the detector the LED will illuminate for approx 1s to indicate that the Detector Contact has been triggered
- If any external Magnetic Contact Sets are connected to the Detector, operate these one at a time. Each time a contact is opened the LED on the Detector should illuminate for 1s to indicate that it has been triggered.
- Replace the battery cover on the Detector.

# TESTING THE SYSTEM

## INITIAL TESTING

As the system is initially installed it is recommended that each device is tested in turn as it is installed, (refer to testing instructions for particular device).

## TESTING AN INSTALLED SYSTEM

1. Before commencing testing please ensure the following conditions apply:
  - The system is in Operating mode and Disarmed
  - There is no movement in any PIR protected area.
  - All doors/windows protected by Magnetic Contact Detectors are closed.
  - All battery covers and housings are correctly fitted.
2. Arm the system by pressing the 'INSTANT-ARM' button on the Remote Control. The Siren will acknowledge the signal by beeping once, (unless Beep Disable has been selected).
3. After 45 seconds walk into an area protected by a PIR Movement Detector and ensure that a Full Alarm condition is initiated, (i.e. the Siren sounds).
4. Stop the Siren and Disarm the system by pressing the 'DISARM' button on the Remote Control.
5. Continue to test the all PIR Movement Detectors in turn as described above, (steps 2 - 4). Remember that the detectors need to settle for at least 40 seconds between each activation.
6. Arm the system by pressing the 'INSTANT-ARM' button on the Remote Control.
7. Open a door/window protected by a Magnetic Contact Detector and ensure that a Full Alarm condition is initiated.
8. Stop the Siren and Disarm the system by pressing the 'DISARM' button on the Remote Control.
9. Test each Magnetic Contact Detector in turn as described above, (steps 6 - 8).
10. Arm the system by entering the User Access code followed by the 'INSTANT-ARM' button on the Remote Keypad.
11. Press and hold both 'DELAY-ARM' buttons on the Keypad for approx 2-3 seconds and ensure that a Full Alarm condition is initiated.

12. Stop the Siren and Disarm the system by entering the User Access code followed by the DISARM button on the Keypad.

**Note:** It is recommended that the system is tested at regular intervals, (every 3 months), to ensure that all elements of the system are operating correctly.

## OPERATING INSTRUCTIONS

### SYSTEM SERVICE MODE

To prevent a Full Alarm condition from being initiated when either opening the Solar Siren or replacing a battery, it is necessary to first put the system to Service mode by pressing and holding the 'DISARM' button on the remote control for approximately 10 seconds. The Siren will acknowledge the signal by beeping twice followed by one long beep after 10 seconds, the 'DISARM' button can then be released.

When you have completed any alterations to the system turn the system back to Operating Mode.

### SYSTEM OPERATING MODE

To put the system back into Operating Mode press and hold the 'INSTANT-ARM' button on the Remote Control for approximately 10 seconds until the Siren acknowledges the signal by emitting one long beep. The system will be in Operating mode in a Disarmed state.

**Note:** The 'INSTANT-ARM' button should be released during or immediately after the long beep, otherwise the system will switch into an Armed state.

### ARMING THE SYSTEM

When leaving the premises, the system must be armed. However, before doing so, check that all windows are closed and locked, all protected doors are closed and PIR Movement Detectors are not obstructed. Ensure that pets are restricted to areas not protected by PIR Movement Detectors.

The system has two Armed modes, Instant and Delay.

Instant mode will immediately set the system into a fully armed state. Any activation of a Detector will

immediately generate a Full Alarm condition. On returning to and entering the property the system must be Disarmed before opening any protected door or entering an area protected by a PIR movement detector otherwise a Full Alarm condition will occur.

Delay mode will arm the system with a 15 second entry/exit delay. On arming the system in Delay mode there will be a 15 second delay before the system becomes fully active. This allows time for you to leave the property before the system becomes fully active. On returning to and entering the property by opening a protected door or moving through a PIR protected area the system will be triggered and the Siren will emit a single long beep. However, a Full Alarm will not be initiated until the 15 second entry delay has expired during which time the system should be Disarmed. If the system is not Disarmed within the entry delay period a Full Alarm condition will occur.

If a Full Alarm condition is initiated following an intrusion and a detector being triggered, (while the system is armed), the Siren will sound continuously until the pre-set alarm duration time (1 or 3 minutes) expires when the siren will cease. The system will then immediately automatically reset and re-arm itself. In the event that a further detector is triggered the system will once again initiate a Full Alarm condition. This process can be repeated up to three times after which time the system will not automatically reset.

If a Full Alarm condition is initiated accidentally the alarm can be stopped immediately by pressing the 'DISARM' button on the Remote Control.

### Arming The System Instant Mode

The system can be armed in Instant mode using either the Remote Control or the Keypad as follows:

#### Remote Control:

Press the 'INSTANT-ARM' button, 

The Siren will acknowledge the signal by beeping once.

#### Keypad:

Enter the User Access code followed by the 'INSTANT-ARM' button



The Siren will acknowledge the signal by beeping once.

### Arming The System In Delay Mode

The system can be armed in Delay mode using either the Remote Control or the Keypad as follows:

#### Remote Control:

Press the 'DELAY-ARM' button, 

The Siren will acknowledge the signal by beeping once and then again after the 15s entry/exit period has expired. The system will not be fully armed and active until after the second beep.

#### Keypad:

Enter the User Access code followed by followed by either 'DELAY-ARM' button.



The Siren will acknowledge the signal by beeping once and then again after the 15s entry/exit period has expired. The system will not be fully armed and active until after the second beep.

### DISARMING THE SYSTEM

The system can be Disarmed using either the Remote Control or the Keypad as follows:

#### Remote Control:

Press the 'DISARM' button, 

The Siren will acknowledge the signal by beeping twice.

#### Keypad:

Enter the User Access code followed by the 'DISARM' button





The Siren will acknowledge the signal by beeping twice.

**IMPORTANT:** If, when the system is disarmed, the siren emits a series of ten rapid beeps, this indicates that a Full Alarm condition has been triggered whilst the system was armed. Check the security of the property before entering.

## PERSONAL ATTACK (PA) ALARM

A full alarm condition can be immediately initiated by the user at any time (whether the system is armed or disarmed) in the event of threat or danger by activating the Personal Attack (PA) facility.

To initiate a Personal Attack alarm from the Remote Control slide the Personal Attack switch upwards.

To initiate a Personal Attack alarm from the Keypad press and hold both the  and  buttons together for 2 seconds.

A Full Alarm condition will be initiated which will continue for the alarm duration time (1 or 3 minutes) when the system will automatically reset or disarmed from the Remote Control or Keypad.

## BATTERY MONITORING

All system devices continuously monitor their battery condition . When a low battery indicator is activated the device will continue to operate normally for up to 2 weeks (depending upon system use). However, the battery for that device should be replaced as soon as possible.

Before replacing the battery in any device turn the system to Service mode as previously described. When the batteries have been replaced, the system should be turned back to Operating Mode.

The low battery indication for each system component is as follows:

### Remote Control

When the Remote Control is operated under low-battery conditions the transmit LED will continue to flash after the button has been released.

Under normal battery conditions the LED will extinguish when the button is released.

### Keypad

Under low-battery conditions the 'low-batt' LED on the keypad will be illuminated

**Note:** The Keypad will retain the User Access code setting for approximately 15 seconds whilst the battery is removed and replaced. If the battery is left disconnected for a longer period, or has been allowed to run completely flat the User Access code will revert to the factory default code of 1 2 3 4 when the new battery is connected. The User Access code will then need reprogramming as detailed on page 8.

### PIR Movement Detectors

If the voltage level of any PIR battery falls below 7.5 Volts, the LED behind the detector lens will flash when movement is detected to indicate that the battery needs to be replaced.

Under normal battery conditions the LED does not illuminate unless the PIR detector is in Walk Test mode.

### Magnetic Contact Detectors

When the Detector is activated, under low-battery conditions the transmit LED will be illuminated for approximately 1 second as the door/window is opened.

Under normal battery conditions the LED not illuminate as the Detector is operated, (unless the Detector is in Test Mode with the battery cover removed).

## MAINTENANCE

Your Alarm System requires very little maintenance. However, a few simple tasks will ensure its continued reliability and operation.

**IMPORTANT:** Should you, for any reason, have to completely power-down the system (e.g. to move the system to a new premises) first put the system into Service mode before removing the Solar Siren cover and disconnecting the main rechargeable and initial power-up batteries. Ensure that the solar panel is covered with a light proof material to prevent it being energised.

### SOLAR SIREN

1. It is recommended that the Solar Panel on the top of the siren housing should be cleaned at least twice a year, preferably in the Spring and Autumn, using a soft damp cloth. Do not use abrasive, solvent based or aerosol cleaners. Do not attempt to clean inside the unit or allow water to enter the unit.

This will ensure that the Solar Panel does not become affected by the build up of excessive dirt and receives all the available light.

2. The Solar Siren should not be left for long periods with the batteries connected, unless the unit is able to receive sufficient light to maintain the

battery charge. Failure to maintain charge to the unit will result in the rechargeable battery running unacceptably low. Should this occur, the unit must be recharged from a 7.5Vdc/100mA supply (e.g. from a mains adaptor power supply). When re-powering the Solar Siren fit a new 9V PP3 leak proof Alkaline power-up battery to ensure that the Unit receives sufficient power until the solar panel can recharge the main battery.

3. The main rechargeable battery has a typical life of 3-4 years and needs no maintenance during this period, provided the battery is kept charged. The battery will be damaged if it is stored in a discharged state for long periods.

### DETECTORS, REMOTE CONTROL AND KEYPAD

The Detectors require very little maintenance. The batteries should be replaced once a year or when a low battery status is indicated.

### BATTERIES

**Note:** Before removing the battery cover on any device to replace the battery ensure that the system is put into Test mode to avoid initiating a Full Alarm condition.

The specifications for replacement batteries are as follows:

Remote Controls:	1 x 3V CR2032 Lithium Cells (or equivalent)
Magnetic Contact Detectors:	2 x 3V CR2032 Lithium Cells (or equivalent)
Keypad:	1 x 9V PP3 Alkaline
PIR Movement Detectors:	1 x 9V PP3 Alkaline

**Note:** Where applicable only fit PP3 Alkaline type batteries. Rechargeable batteries should NOT be fitted.

At the end of their useful life the batteries should be disposed of via a suitable Recycling Centre. Do not dispose of with your normal household waste. DO NOT BURN.

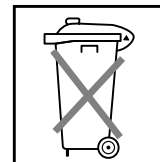

**Pb**

The Rechargeable Batteries contain Sulphuric Acid - DO NOT ATTEMPT TO OPEN THE CASING.

## ALARM RECORD

You may make a note of your User Access Codes and Installer Access Code below.

#### User Access Code

#### System House Code

ON

12345678

Use the above diagram to record your House Code e.g.  = ON

***This information is confidential and should be kept in a safe location.***

# TROUBLE SHOOTING

<b>Symptom / Recommendation</b>	<b>Symptom / Recommendation</b>
<p><b>Siren gives full alarm condition when arming.</b></p> <ol style="list-style-type: none"> <li>1. Siren anti-tamper switch activated - adjust tamper plunger and ensure that switch fully closes when Siren is mounted. If the wall is excessively uneven, the siren may need relocated to a more suitable position.</li> </ol>	<ol style="list-style-type: none"> <li>b. Check age of rechargeable battery – replace if at end of useful life.</li> <li>c. Fit new initial power-up battery and re-power up siren.</li> </ol>
<p><b>Siren gives full alarm condition when system has not been activated by an intruder or is disarmed.</b></p> <ol style="list-style-type: none"> <li>1. Tamper switch activation - check all detector battery covers for security and Solar Siren for adequate fixing against external wall.</li> <li>2. Personal Attack Alarm operated from a Remote Control or Keypad.</li> <li>3. Jamming detection circuit operation (see page 5).</li> </ol>	<p><b>LED on Remote Control not illuminating, or is dim when unit is operated.</b></p> <ol style="list-style-type: none"> <li>1. Ensure battery is connected with correct polarity.</li> <li>2. Ensure battery connections are good.</li> <li>3. Replace battery with Alkaline type.</li> </ol>
<p><b>Siren not responding to detector.</b></p> <ol style="list-style-type: none"> <li>1. Detector battery low - Replace detector battery.</li> <li>2. System in Service Mode - Turn to Operating mode using Remote Control (see 'System Operating Mode' page 14).</li> <li>3. Ensure that the detector 'House Code' is the same as that set on the Siren.</li> <li>4. Ensure detector is within effective radio range of Solar Siren and equipment is not mounted close to metal objects.</li> </ol>	<p><b>Keypad not operating ('On-Air' light does not illuminate).</b></p> <ol style="list-style-type: none"> <li>1. Incorrect Access Code being entered.</li> <li>2. Battery low - replace battery.</li> </ol>
<p><b>Siren not responding to Remote Control or Keypad.</b></p> <ol style="list-style-type: none"> <li>1. Ensure that the 'House Code' is the same as that set on the Siren.</li> <li>2. System in Service Mode - Turn to Operating mode using Remote Control (see 'System Operating Mode' page 14).</li> <li>3. Incorrect User Access code being entered at Keypad.</li> <li>4. Remote Control/Keypad battery flat - replace battery.</li> <li>5. Reset system:               <ol style="list-style-type: none"> <li>a. Disconnect Siren rechargeable and initial power-up batteries.</li> <li>b. Cover Solar panel with light proof material and leave system for 1 minute.</li> <li>c. Reconnect batteries and then remove Solar panel cover and take out of Service Mode.</li> </ol> </li> <li>6. Siren rechargeable battery discharged:               <ol style="list-style-type: none"> <li>a. Clean Solar Panel.</li> </ol> </li> </ol>	<p><b>PIR Movement Detector false alarming.</b></p> <ol style="list-style-type: none"> <li>1. Ensure that the detector is not pointing at a source of heat or a moving object.</li> <li>2. Ensure that the detector is not mounted above a radiator or heater.</li> <li>3. Ensure that the detector is not facing a window or in direct sunlight.</li> <li>4. Ensure that the detector is not in a draughty area.</li> <li>5. Pulse count set too low – reset to two pulse detection.</li> </ol>
	<p><b>PIR Movement Detector not detecting a person's movement.</b></p> <ol style="list-style-type: none"> <li>1. Check battery connections are good.</li> <li>2. Pulse count set too high - reset to one pulse detection.</li> <li>3. Check that the detector is correctly set up. (See setting the PIR Movement Detectors page 7).</li> <li>4. Ensure DIP switches 1-4 of SW3 are correctly set.</li> <li>5. Ensure that detector is mounted the correct way up, (i.e. with detection window at the bottom).</li> <li>6. Ensure that the detector is mounted at the correct height, (i.e. 2-2.5m).</li> <li>7. Allow up to three minutes for detector to stabilise.</li> </ol>
	<p><b>PIR Movement Detector LED flashes on detection of movement, (device in normal operation mode).</b></p> <ol style="list-style-type: none"> <li>1. Low battery - replace battery.</li> </ol>

## TROUBLE SHOOTING - continued

<b>Symptom / Recommendation</b>	<b>Symptom / Recommendation</b>
<p><b>Magnetic Contact Detector not working.</b></p> <ol style="list-style-type: none"> <li>1. Ensure batteries are connected with correct polarity.</li> <li>2. Ensure battery connections are good.</li> <li>3. Ensure 'House Code' is the same as Solar Siren.</li> <li>4. Ensure DIP switches 9 and 10 are set correctly.</li> <li>5. If no external contacts are connected ensure jumper link fitted.</li> <li>6. If external contacts are connected:               <ol style="list-style-type: none"> <li>a. Ensure jumper link removed.</li> <li>b. Check that all contacts are closed.</li> <li>c. Check all contacts are wired in series.</li> </ol> </li> </ol>	<p><b>Magnetic Contact Detector false alarming.</b></p> <ol style="list-style-type: none"> <li>1. Ensure that gap between magnet and detector is less than 10mm.</li> <li>2. Tamper switch below battery cover not depressed - check battery cover is fitted correctly and that fixing lugs are not broken.</li> </ol>
	<p><b>LED on Magnetic Contact Detector illuminating when door or window is opened.</b></p> <ol style="list-style-type: none"> <li>1. Low battery - replace Batteries.</li> </ol>

**IF YOU HAVE ANY PROBLEMS  
RING THE HELPLINE:**

01268 563273

(Lines open 9.00am  
to 5.00pm, Monday  
to Friday.)

**Important  
notice  
following  
alarm  
installation:**

In order to comply with the Code of Practice on Noise from Intruder Alarms 1981 you should carry out the following procedures within 48 hours of Intruder Alarm installation.

1. Notify your local police station in writing that an Intruder Alarm System has been installed, giving names and contact details of at least two persons who have a Remote Control or know the User Access code for the Keypad.
2. Inform the Local Environmental Health Authority of the installation and which police station has been informed.
3. Ensure that all users are aware of the operating procedures.
4. Immediately inform your Local Authority and police station if there is a change to the persons who have Remote Controls.

# EXTENDING YOUR ALARM SYSTEM

Your system may be extended to provide additional protection by adding additional PIR Movement Detectors, Magnetic Contact Sets and Remote Control Units.

## ACCESSORIES

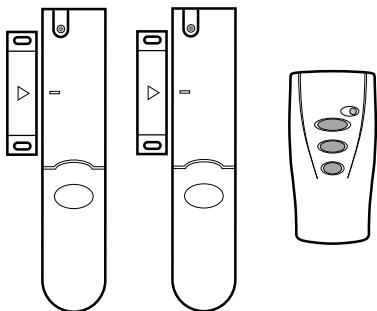

**SU1**

### **SU1 - ACCESSORY SET**

Comprises: 2 x Magnetic Contact Sets and 1 x Remote Control Unit.

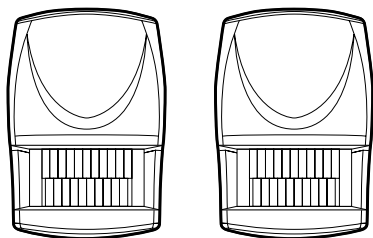

**SU2**

### **SU2 - PIR MOVEMENT DETECTORS (TWIN PACK)**

Comprises: 2 x PIR Movement Detectors.

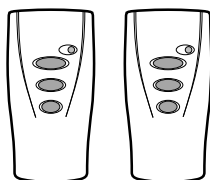

**SU3**

### **SU3 - REMOTE CONTROL UNITS (TWIN PACK)**

Comprises: 2 x Remote Control Units.

***If you have a problem with your Alarm,  
please call the Helpline on:***

**01268 563273**

(Lines open 9.00am to 5.00pm, Monday to Friday).

***We can solve most problems quickly over the phone.***

---

## **GUARANTEE**

This product (excluding Alkaline batteries) is guaranteed for one year from the date of purchase against faulty materials or workmanship. We will repair or replace any faulty product. No liability can be accepted for any problems caused by fair wear and tear, buyers negligence, improper fitting or use, local radio interference, wilful or accidental damage, or any consequential loss or damage howsoever caused. This guarantee does not affect your statutory rights and is valid in the UK and Eire only.

If an item develops a fault, the product must be returned to the address below in adequate packaging with:

1. A copy of your original invoice/receipt.
2. A full description of the fault.
3. All relevant batteries.

### **NOTE:**

If returning a Solar Siren, make sure that the rechargeable battery and initial power up battery are disconnected and secure and that the unit is packaged to prevent damage in transit.

For security, Recorded or Registered Post is recommended.

**Response, Novar Electrical Devices and Systems.**

**The Arnold Centre, Paycocke Road,**

**Basildon, Essex. SS14 3EA.**

Novar Electrical Devices  
and Systems are  
Quality Assurance Registered  
to BS EN ISO9001 1994,  
by Asta.

## External Solar Siren

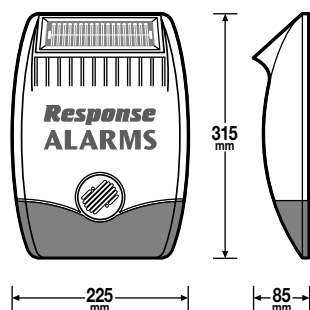

- RF operating frequency: 433MHz
- Sealed lead acid battery 6V/1.2Ahr
- Solar Panel 7.5V - Charge Rate typically 60mA
- Operation time in complete darkness - up to 40 days
- Instant alarm mode
- 15s Entry/Exit Delay alarm mode
- High Power Piezo Siren
- Switchable Alarm Duration: 1 and 3 minutes
- Auto reset on activation
- Siren Disable (selectable)
- Dual front and rear anti-tamper protection
- Jamming Detection
- Audible confirmation (selectable)

## Remote Control

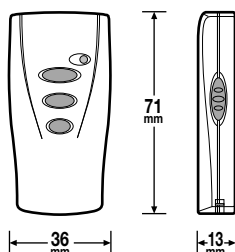

- RF operating frequency: 433MHz
- Range: 50m max.
- Changeable 4 digit User Access code.
- Instant alarm mode
- 15s Entry/Exit Delay alarm mode
- Anti-Tamper protected
- Personal Attack (PA) facility
- Battery Life > 1 year
- Low Battery Indicator

## Keypad

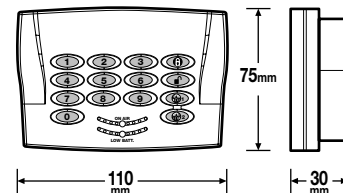

- RF operating frequency: 433MHz
- Range: 50m max.
- INSTANT-ARM, DELAY-ARM and DISARM buttons
- Personal Attack (PA) switch
- Instant alarm mode
- 15s Entry/Exit Delay alarm mode
- Transmission indicator
- Battery life > 1 year
- Low battery indicator

## Passive Infra-Red Movement Detector

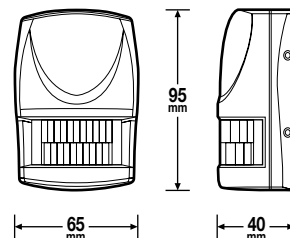

- RF operating frequency: 433MHz
- Range: 75m max.
- Detection range: up to 12m at 110° and 6m at 180°
- Walk test facility
- One or Two pulse count detection
- Anti-Tamper protected
- Corner or surface mount
- Battery Life > 1 year
- Low Battery Indicator

## Magnetic Contact Detector(s)

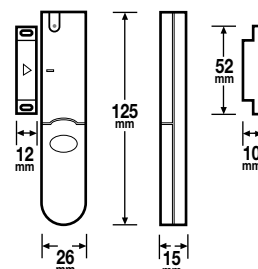

- RF operating frequency: 433MHz
- Range: 75m max.
- Test Mode
- Anti-Tamper protection
- Facility to add external wired Magnetic Contacts or Personal Attack buttons
- Battery Life >1 year
- Low Battery Indicator

### RESEARCH & DEVELOPMENT

Our R & D Department is constantly developing new products. We practice a policy of continued improvement and reserve the right to change specifications without prior notice.