

Friedland

SA3

6 Zone Wirefree Alarm System



Installation & Operating Manual

FOREWORD

All components in this wirefree Alarm System are designed and manufactured to provide a high standard of security protection and long, reliable service.

The system is designed for ease of installation using only conventional domestic tools. However, it is essential that the installer reads and fully understands the advice and procedures contained in this manual and plans the system before proceeding with the installation.

During installation, it is important that the procedures described in this manual are followed in sequence.

This manual should be retained in a safe place for future reference.

IMPORTANT

All components, with the exception of the External Solar Siren are suitable for mounting in dry interior locations only.

DECLARATION

Novar ED&S hereby declares that this wirefree alarm system is in compliance with the essential requirements and other relevant provisions of the Radio and Telecommunications Terminal Equipment (R&TTE) directive, 1999/5/EC.

No radio operating licence is required for this equipment.

Tools and Equipment Required:

No.0 Philips Screwdriver	Drill
No.1 Philips Screwdriver	Bradawl
No.2 Philips Screwdriver	Small Spirit Level
5 & 6mm Masonry Drill Bits	

DEVICE RANGE

The quoted range of the system devices (see component specification on rear cover) is measured in ideal conditions. Any solid object (e.g. walls, ceilings, reinforced PVC doors etc) placed between the transmitter devices and the Receiver(s) will reduce the transmission range of the devices.

The amount by which the range will be reduced is dependant upon the nature of the barrier. e.g.

Wall Type	Range Reduction
Dry-lined partition wall:	10-30%
Single layer brick wall:	20-40%
Double layer brick wall:	30-70%
Metal Panel/Radiator:	90-100%

Note: The effect on the range of multiple walls is cumulative. i.e. if there are two brick walls in the way, the range will be reduced by up to 40% by each wall.

SYSTEM SECURITY

This system has been designed to both detect intruders and act as a strong deterrent to would-be intruders when installed correctly.

Please remember that given adequate knowledge and time it is possible to overcome any alarm system and we therefore recommend that an Intruder Alarm is used in conjunction with good physical protection such as security window and door locks.

All units in the system are encoded to operate together using an 8 bit House Code which is configured by the user/installer to provide the unique identification code for your installation. The system House Code can be changed at any time by the user.

The system is operated from one or more Remote Control units and/or the Control Panel. Care should be taken to ensure that your Remote Control Unit(s) are not lost or the User Access Codes for the Control Panel do not become known to other people as this will compromise the security of your system. In either event the system house code and User Access Codes should be changed as soon as possible.

IMPORTANT: All units in your system must be set to the same House Code which must be changed from the factory supplied setting.

SAFETY

Always follow the manufacturers advice when using power tools; steps, ladders etc. and wear suitable protective equipment (e.g. safety goggles) when drilling holes etc.

Before drilling holes in walls, check for hidden electricity cables and water pipes, the use of a cable/pipe locator maybe advisable if in doubt.

When using ladders, ensure that they are positioned on a firm stable surface at the correct angle and suitably secured before use.

The use of ear defenders is advisable when working in close proximity to the Siren due to the high sound level produced by this device.

CONTENTS

	Page No.		Page No.
KIT CONTENTS	2	EXTERNAL CONNECTIONS	17
INTRODUCTION AND OVERVIEW	3	TESTING THE SYSTEM	17
System Arming	3	Initial Testing	17
Entry/Exit Delay	3	Testing An Installed System	17
Zones	3		
Zone Lockout	3	FACTORY DEFAULTS	18
Tamper Protection	4	Reset Factory Default Conditions	19
Jamming Detection	4		
Battery Monitoring	4	PROGRAMMING	19
System House Code	4	User Access Code	19
		System House Code	19
PLANNING AND EXTENDING YOUR WIREFREE ALARM SYSTEM	5	Instant/Delay Zones	20
		Entry/Exit Delay	20
REMOTE CONTROL UNIT	6	Alarm Duration	20
General Information	6	Part-Arm	20
Configuring the Remote Control	7	Zone Lockout	21
		Entry/Exit Warning Tone	21
CONTROL PANEL	7	Jamming Detection	21
Positioning the Control Panel	7	NO/NC Relay Contacts	22
Installing the Control Panel	7	Zone Operating Modes	22
Configuring the Control Panel House Code	8	OPERATING INSTRUCTIONS	23
Testing the Control Panel & Remote Control	9	Arming The System	23
		Part-Arming The System	23
PASSIVE INFRA-RED (PIR) MOVEMENT DETECTORS	10	Disarming The System	23
Positioning the PIR Movement Detectors	10	Personal Attack (PA) Alarm	24
Installing and Configuring the PIR Movement Detectors	11	Tamper	24
Testing the PIR Movement Detectors	12	Siren Service Mode	24
		Siren Operating Mode	24
MAGNETIC CONTACT DETECTORS	12	Battery Monitoring	25
Positioning the Magnetic Contact Detectors	13	MAINTENANCE	25
Installing and Configuring the Magnetic Contact Detectors	13	ALARM RECORD	26
Testing the Magnetic Contact Detectors	14		
		TROUBLE SHOOTING	27
EXTERNAL SOLAR SIREN	14		
General Information	14	EXTENDING YOUR ALARM SYSTEM	29
Positioning the Solar Siren	15		
Installing and Configuring the Solar Siren	15	COMPONENT SPECIFICATION	Back Cover
Power-up of the Solar Siren	16		
Testing the Solar Siren	17		

KIT CONTENTS

The Alarm System should contain the following components.

- 1 x External Solar Siren
- 1 x Control Panel
- 1 x Remote Control
- 2 x PIR Movement Detectors
- 2 x Magnetic Contact Detectors

Also included:

- Power Supply Adaptor
- Installation & Operating Manual
- Fixing pack
- Batteries

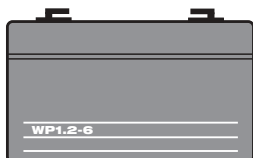

6V/1.2Ahr
Sealed lead acid battery
(supplied fitted in
Solar Siren)

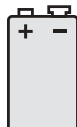

9V PP3 Alkaline
battery
(for PIR Detectors)



3V CR2032
Lithium Cell
(for Remote
Control and
Magnetic Contact
Detectors)

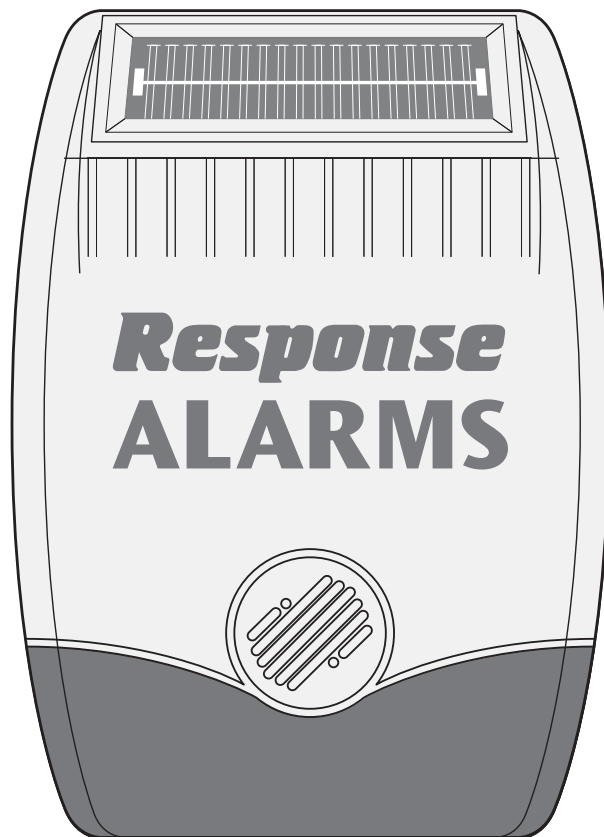

External Solar Siren

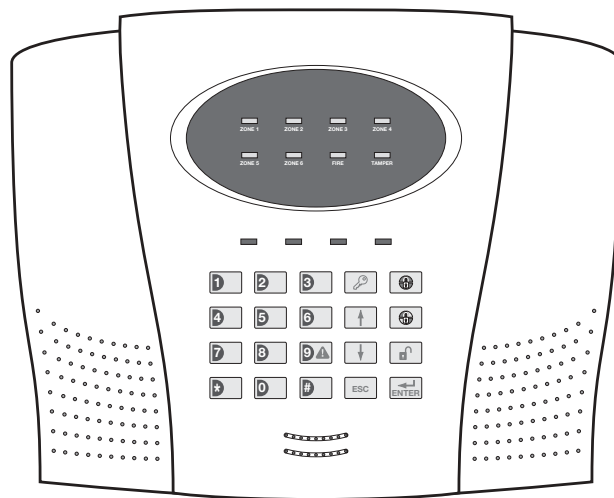

Control Panel

EXTENDING THE ALARM SYSTEM

The following additional accessories are available to enhance your system and provide further protection and a higher level of security where required.

Component:	Product Code
Two Magnetic Contact Detectors and one Remote Control	SU1
Two Passive Infra-Red Movement Detectors	SU2
Two Remote Controls	SU3
Two Magnetic Contact Detectors	SU4
Remote Keypad	SU5
External Solar Siren	SU6

Full details of these accessories are given on page 29.

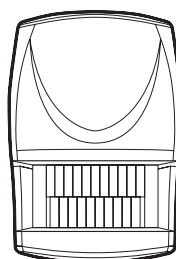

PIR Movement Detector

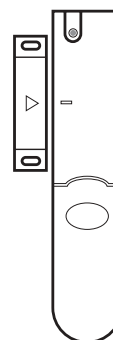

Magnetic Contact Detector

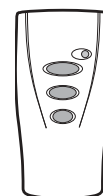

Remote Control

INTRODUCTION AND OVERVIEW

SYSTEM ARMING

The system has a full 'Arm' and a 'Part-Arm' mode. Full ARM will arm all zones while the 'Part-Arm' will only arm the zones that are enabled for "Part-Arm".

For example:

The system could be configured such that during night time, 'Part-Arm' would arm only zones protecting the lower floor and outbuildings leaving the upper floor free for movement without triggering the alarm.

However, when the property is left un-occupied, the full 'Arm' mode will arm all zones to protect the entire property, (i.e. upper and lower floors and outbuildings).

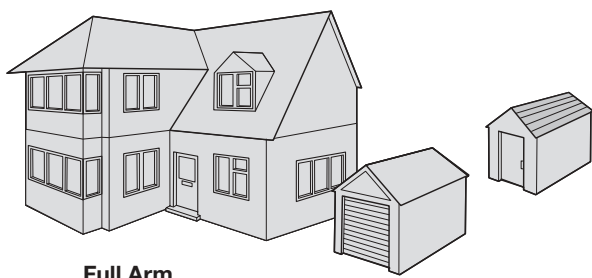

Full Arm



Part-Arm

ENTRY/EXIT DELAY

Each zone can be programmed to be Armed in either Instant or Delay mode.

Usually the zone covering the main entrance door and the route to and from the Control Panel would be configured in Delay mode. This allows time for the user to exit the property after setting the system at the Control Panel or to Disarm the system before an alarm condition is triggered when re-entering the property. The remaining zones would be configured as Instant allowing them to initiate an alarm immediately a detector on the zone is triggered.

Delay Armed zones will not become fully armed until after the Entry/Exit delay period has expired. When a

detector on a Delay Armed zone is triggered, an alarm condition will not be triggered until after the Entry/Exit period has elapsed. If the system is not disarmed during the delay period, an alarm condition will occur when the delay period expires.

Instant Armed zones are immediately able to initiate an alarm as soon as the system begins to arm.

Note: To conserve power and maximise battery life the PIR Detector will only detect movement if there has been no movement detected within the previous 2 minutes. Consequently the PIR Detector will not become active until the protected area has been free from movement for more than 2 minutes.

ZONES

The system incorporates 6 wirefree Alarm Zones for the connection of the system detectors that are used to independently monitor different areas of the property. In addition to standard intruder protection, each zone may also be configured to operate in one of three other modes:

- 'Personal Attack' mode provides 24 hour monitoring of any Personal Attack (PA) switches incorporated into the system.
- '24-hour Intruder' mode provides 24 hour intruder protection for areas where continuous monitoring is required, (e.g. gun cupboards).
- 'Fire' mode provides 24 hour monitoring of any Fire/Smoke detectors incorporated into the system.

ZONE LOCKOUT

If a detector on an active zone is triggered while the system is armed an alarm condition will occur. After the programmed alarm duration has expired the alarm will stop and the system will automatically reset. Subsequent detectors triggered will again initiate an alarm condition. If a single zone initiates an alarm condition more than three times then that zone will be 'Locked Out' and any further alarm signals from that zone will be ignored until the system is disarmed.

Note: The 'Zone Lockout' feature can be disabled if required.

TAMPER PROTECTION

All system devices (except any Remote Control Units) incorporate Tamper protection features to protect against unauthorised attempts to interfere with the device.

Any attempt to remove the battery cover from any device (except a Remote Control) or to remove the Solar Siren or Control Panel from the wall will initiate an alarm condition (unless the system is in Test or Programming modes), even if the system is Disarmed.

JAMMING DETECTION

In order to detect any attempts to illegally jam the radio channel used by your alarm system, a special jamming detection function is incorporated into the Control Panel and Solar Siren. If this feature is enabled, and the radio channel is jammed continuously for 30 seconds, when the system is armed, the Solar Siren will emit a pre-alarm series of rapid bleeps for 5 seconds. If the jamming continues for a further 10 seconds or more a full alarm condition will occur. In addition if the system is jammed for more than three periods of 10 seconds in a 5 minute interval, this will also generate a Full Alarm condition.

The Jamming Detection circuit is designed to permanently scan for jamming signals. However, it is possible that it may detect other local radio interference operating legally or illegally on the same frequency. If it is planned to operate the jamming detection feature we recommend that the system is monitored for false jamming alarms for at least 2 weeks prior to leaving the Jamming Detection function permanently enabled.

Note: The jamming detection features incorporated into the Control Panel and optional Solar Siren operate independently.

BATTERY MONITORING

All devices powered by non-rechargeable batteries incorporate a battery level monitoring feature which will warn of a low battery status. In addition the Control Panel will also indicate a low battery status within any Passive Infra-Red or Magnetic Contact Detector on the system. The batteries on any device indicating a low battery status should be replaced immediately.

SYSTEM HOUSE CODE

In order to prevent any unauthorised attempt to operate or disarm your system, you must configure your system to accept radio signals only from your own system devices. This is done by setting a series of eight miniature (DIP) switches in all devices (except the Control Panel) to the same ON/OFF combination (the House Code) selected by the user/installer. The Control Panel is then programmed to operate only with devices set to this House Code. All detectors and Remote Control Unit(s) must be configured with the same House Code in order for the system to operate correctly.

Inside the Siren, Detectors and Remote Control Unit is a series of 8 DIP switches.



The House Code is set up by moving each of the 8 switches in each device to the same randomly selected ON/OFF sequence. When setting the DIP switches, ensure that each switch 'clicks' fully into position. Use the tip of a ballpoint pen or a small screwdriver to move each switch in turn.

Note: It is recommended that the system House Code is always changed to a code other than the factory default.

PLANNING AND EXTENDING YOUR WIREFREE ALARM SYSTEM

Before attempting to install your Alarm System it is important to study your security requirements and plan your installation.

PIR Movement Detectors are used to protect the main areas of the property, (e.g. lounge, study, hallway and landing). Magnetic Contact Detectors are typically used to protect the main access points to the property, (e.g. front door, back door, patio doors). However, they can also be used to protect other vulnerable doors/windows or access doors to important rooms.

TYPICAL INSTALLATION

The following example below shows typical property incorporating the suggested positions for the External Siren, PIR and Magnetic Detectors. Use this as a guide for your installation in conjunction with the detailed positioning requirements for each device provided in the appropriate installation sections in this manual for planning your intruder alarm system.

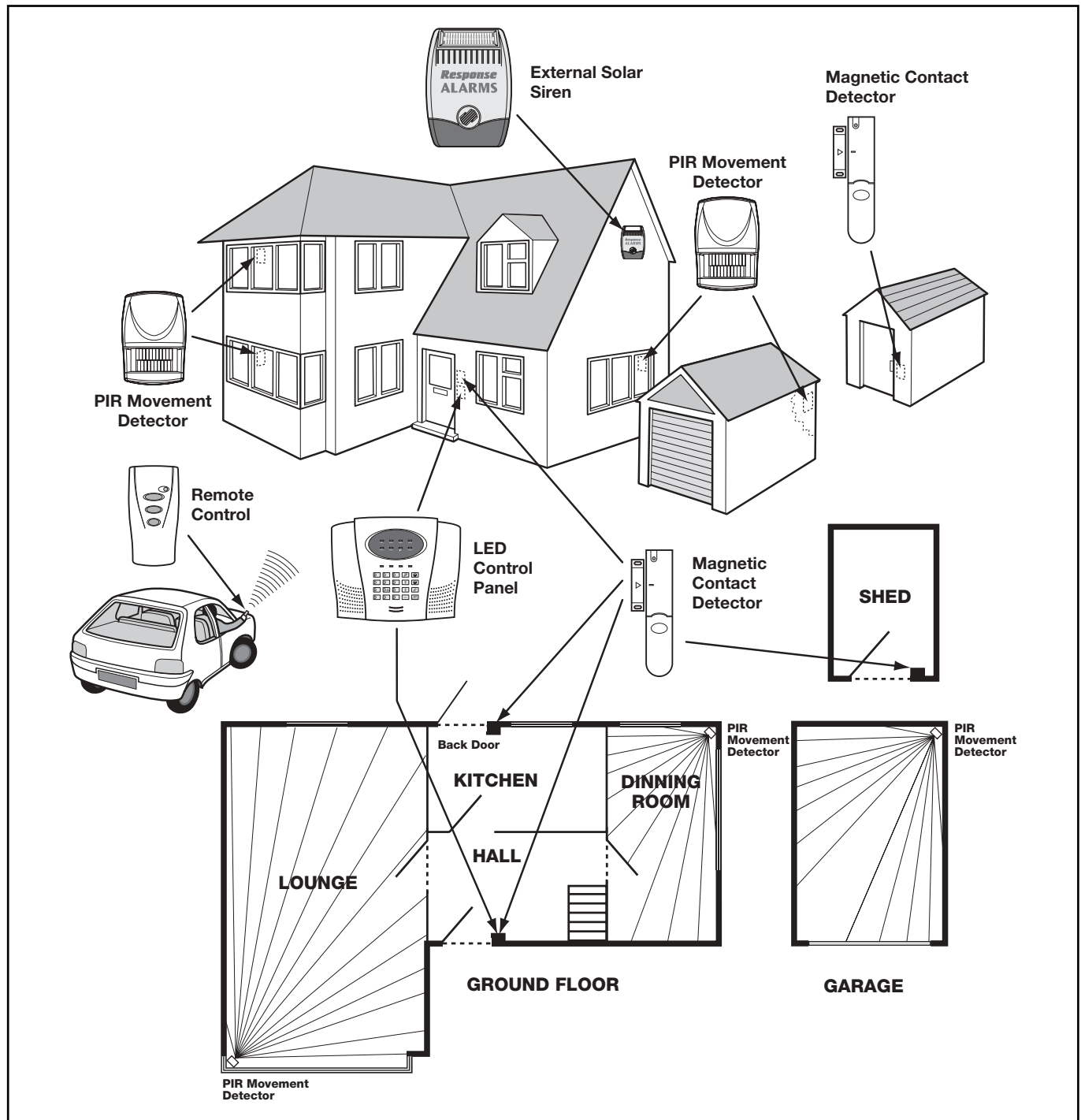

Typical Installation using only detectors supplied:

1. Place the 1st Magnetic Contact detector (set on Zone 1) on the front door.
2. Place the 1st PIR Detector (also set on Zone 1) in the hall covering the Control Panel and routes between downstairs rooms.
3. Place the 2nd Magnetic Contact detector (set on Zone 2) on the back or Patio doors.
4. Place the 2nd PIR Detector either
 - i) downstairs in the main living room containing most valuables, (set on Zone 3), or
 - ii) upstairs on the landing covering the access routes between bedrooms and the stairs, (set on Zone 5). This will be inactive if Part-Arm is used.

Note: All system components must be set to the same House Code.

The system may be expanded with additional detectors, Remote Controls and Keypads to provide even greater protection. However the following rules should be followed:

- a) Any detectors covering the main door and the route to the Control Panel should be set on zone 1 only.
- b) Any detectors covering the remainder of the lower floor should be set on zones 2 to 4 only.
- c) Any detectors placed upstairs should be set on zones 5 or 6 only.

The system default settings are pre-configured to provide a basic functional system to suit most typical basic installations:

- Zone 1 is configured as a Delay zone with a 30s entry/exit delay.

As soon as installation is complete, this should be changed to your own code that only you and other system users know.

All other zones are instant.

- The system has a 3 minute alarm duration.
- Zone Lockout is enabled.
- PART-ARM is configured to operate with detectors on zones 1 to 4 only. Detectors on zones 5 & 6 are inactive in part-arm.

IMPORTANT:
All system components must be set to the same House Code.

The default User Access Code for the Control Panel is "1234", this should be changed to your own code that only you and other system users know as soon as installation is complete.

Note: If you wish to change the system configuration away from the above example and system default settings and customise it to your own unique requirements then refer to the Programming section on page 19.

REMOTE CONTROL UNIT

The Remote Control Unit(s) are used to Arm, Part-Arm and Disarm the system.

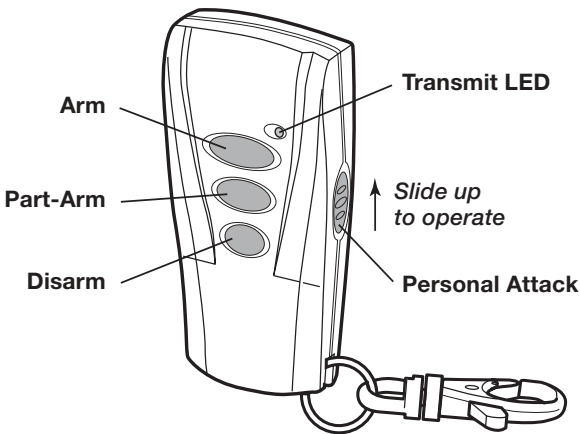

The Remote Control Unit also incorporates a Personal Attack (PA) switch. Activating the PA switch on the side of the Remote Control will immediately initiate a Full Alarm condition whether the system is Armed or Disarmed. The alarm can be cancelled by pressing the 'DISARM' button on the Remote Control or via the Control Panel.

Any number of Remote Control Units can be used with your system, providing they are all coded with the system House Code.

The Remote Control is powered by a CR2032 type Lithium cell which under normal conditions will have an expected life in excess of 1 year. Under normal battery conditions the LED on the Remote Control will only illuminate when a button is pressed. However, under low-battery conditions this LED will continue to flash after the button has been released. When this occurs the battery should be replaced as soon as possible.

CONFIGURING THE REMOTE CONTROL

1. Remove the rear cover by undoing the small screw on the rear of the Remote Control.
 2. Select and record a random combination of 'ON' and 'OFF' positions for the DIP switches. This will be the system House Code that enables all elements of your transmitters to communicate with the Control Panel.
- IMPORTANT:** The House Code for your system should be changed from the factory default setting.
3. Ensure that the jumper link located immediately below the House Code DIP switches is fitted in position for use with this alarm system.
 4. Insert the battery under the clip ensuring that the +ve terminal faces upwards away from the PCB.
 5. Replace the rear cover and fixing screw. Do not over tighten the screw as this could damage the thread.

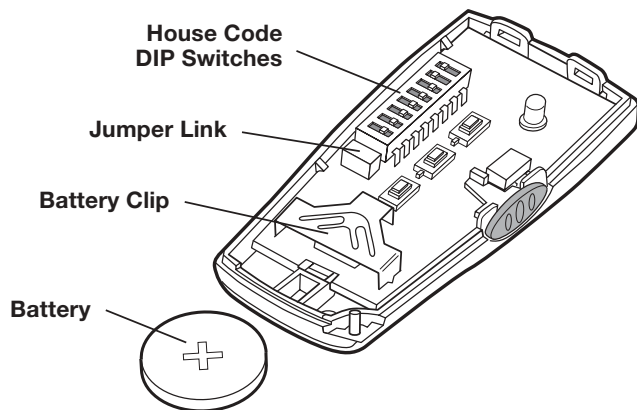

CONTROL PANEL

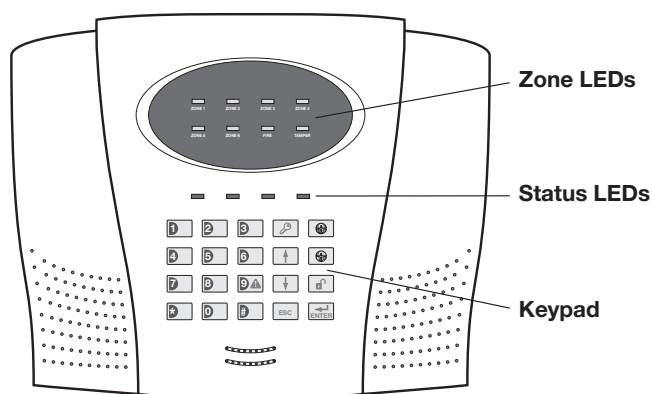

Outside View of Control panel

POSITIONING THE CONTROL PANEL

When choosing a suitable location for the Control Panel, the following points should be considered.

1. The Control Panel should be located in a position out of sight of potential intruders and in a safe location, but easily accessible for system operation.
 2. The Control Panel should be mounted on a sound flat surface to ensure that the rear tamper switch on the Control Panel is closed when the Panel is mounted. The Control Panel should be mounted at a convenient height of between 1.5 and 2m and in a position where it will be seen each day.
- Note:** If small children are in the household, a further consideration should be given to keeping the units out of their reach.
3. It is recommended that the Control Panel should be positioned such that the Exit/Entry tone (emitted by the Control Panel) can be heard from outside the property.
 4. The Control Panel should be mounted within a protected area so that any intruder cannot reach the Control Panel without opening a protected door or passing through an area protected by a PIR movement detector when the system is armed.
 5. The Control Panel must be located within reach of a mains socket.
 6. Do not locate the Control Unit closer than 1m to any large metallic object, (e.g. mirrors, radiators, etc) as this may affect the radio range of the Control Panel.

INSTALLING THE CONTROL PANEL

1. Undo the two captive fixing screws on top of the panel and open the cover. The cover is hinged along the bottom edge.
2. Unclip and remove the two back-up batteries on either side of the panel.
3. Hold the Control Panel in position on the wall and mark the positions of the four fixing holes. Remove the Panel and drill four 5mm holes and fit the 25mm Wall Plugs.

Note: The wall plugs supplied with the product are not suitable for plasterboard walls, if mounting the Control Panel onto plasterboard use appropriate wall plugs.

IMPORTANT: Do not drill the fixing holes with the Control Panel in position; as the resulting dust and vibration may damage the Control Panel's internal components and invalidate the guarantee.

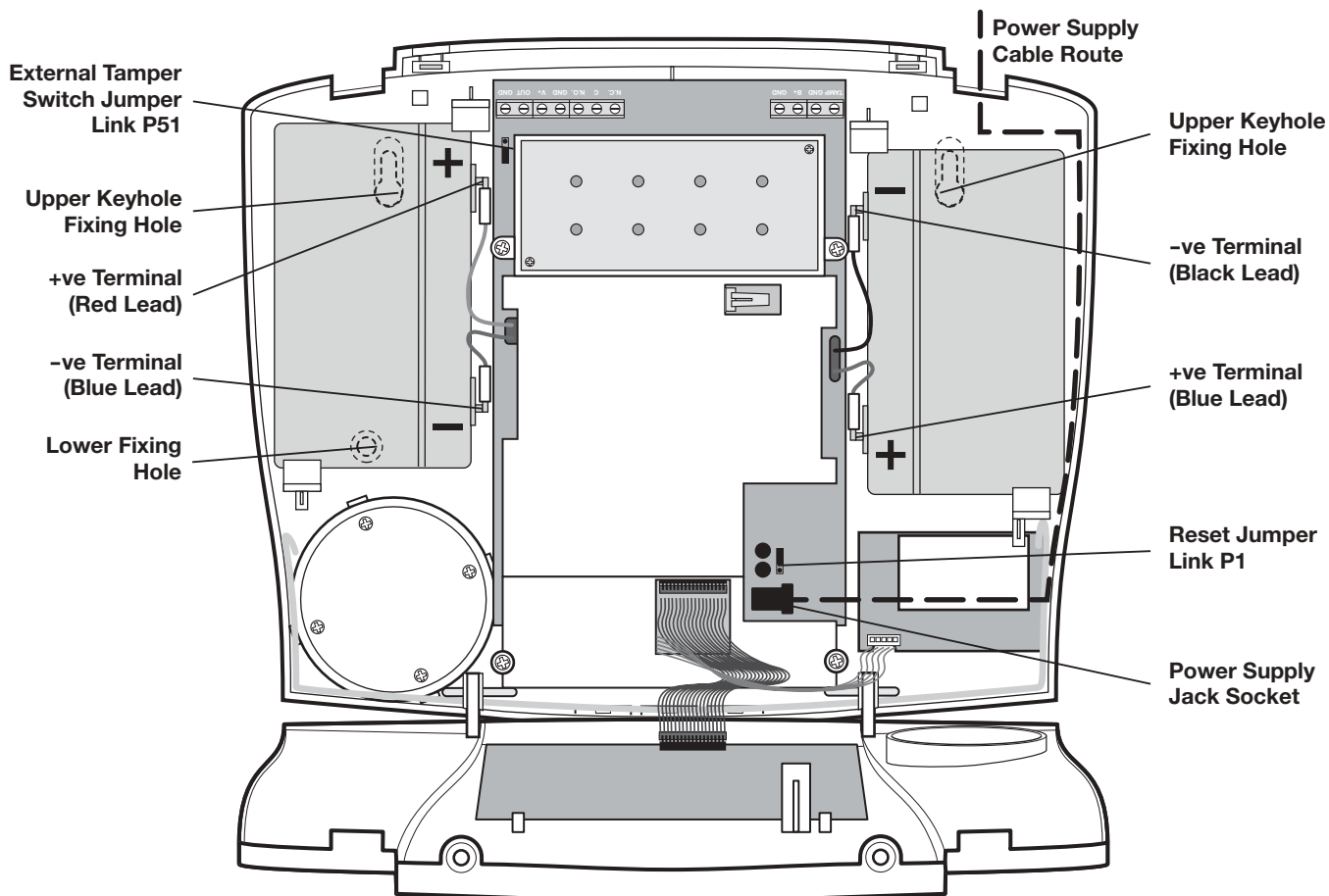

Inside View of Control Panel

4. Fit two 18mm No.4 screws into the top holes until almost fully home and hang the Control panel over these screws using the two keyhole slots in the top corners of the panel casing.
5. Route the cable from the Power Supply Unit up behind and on the right hand side of the Control Panel and connect the plug to the DC power socket in the panel, (see diagram above). Ensure that the cable is not trapped between the panel and the wall.
6. Fix the Panel to the wall using two 18mm No.4 screws in the lower two fixing holes in the panel and tighten the upper fixing screws until they just grip the casing. Do not over tighten the fixing screws as this could damage or distort the casing.
7. Ensure that the "Reset" and the "Hard-Wired Siren tamper detect" jumper links are set in the OFF position.
8. Connect battery leads to both back-up batteries and refit batteries.

Battery 1 (left): Red lead to **+ve** battery terminal
Blue lead to **-ve** battery terminal

Battery 2 (right): Blue lead to **+ve** battery terminal
Black lead to **-ve** battery terminal

IMPORTANT: Take care when connecting battery leads to the batteries as connecting incorrectly could damage the batteries or the Control Panel.

Note: The Power LED may flash to indicate that the unit is being operated from the back-up batteries and that mains supply is not present.

9. Close the lid of the Control Panel and tighten the captive fixing screws.
10. Plug in and switch ON the Power Supply Unit, (the Power LED should illuminate).

Note: If the Panel Tamper alarm sounds during the installation reset the alarm by pressing:



on the Control Panel.

CONFIGURING THE CONTROL PANEL HOUSE CODE

With unit in Standby mode (Power LED only illuminated).

1. Press



The Panel will beep twice and the Arm and Part-Arm LEDs will illuminate. All Zone, Fire and Tamper LEDs will flash.

This puts the Control Panel into programming mode.

2. Press  , 

This configures the Control Panel ready to learn the system house code.

The current House Code setting will be displayed on the Zone, Fire and Tamper indicator LEDs. For example, a house code of 1101 0011, will be indicated as shown below:

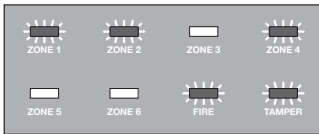

3. The new system House Code can be programmed either directly at the Control Panel or via a Remote Control Unit as follows:

At the Control Panel:

Press buttons 1-8 on the Control Panel to configure the LEDs so that they indicate the required house code. The LEDs will switch to the opposite state each time the corresponding button is pressed.



LED ON = 1, (House Code DIP Switch On/Up)

LED OFF = 0, (House Code DIP Switch Off/Down)

Using a Remote Control:

With the required House Code already configured, press the  button on the Remote Control.

The Control Panel will beep twice to acknowledge the signal and the LED status will change to correspond with the House Code set on the Remote Control.

4. Press  to save the new setting.
 5. Press  again to return to Standby mode.

TESTING THE CONTROL PANEL & REMOTE CONTROL

1. Arm the Panel by pressing the  button on the Remote Control.

The Zone LED will illuminate for a few seconds to indicate which zones are being armed. As the entry/exit delay expires the Panel will slowly beep and the Arm LED will flash. Towards the end of the delay the beep rate will increase. When the Entry/Exit delay is completed the beeping will stop and the Arm LED will stop flashing and be constantly illuminated.

2. Disarm the system by pressing the  button on the Remote Control.

The Panel will beep twice and the Arm LED will turn OFF.



3. Activate the Personal Attack switch on the Remote Control.

The Panel alarm will sound and all Zone/Fire/Tamper LEDs will flash.

4. Disarm the system by pressing the  button on the Remote Control.

The Panel alarm will stop. The LEDs will continue to flash.

5. Press  on the Control Panel to return to Standby mode and cancel any warning LEDs.

6. Test the range of the Remote Control by pressing the  button on the Remote Control from in and around the property and from all locations where you plan to install detectors. Check that the Control Panel acknowledges the signal from the Remote Control by beeping twice each time the  button is pressed.

Note: Wait for 10s after pressing the  button before pressing it again.

7. Press  ,     , 
User Access Code

The Panel will beep to acknowledge the signal and the Arm and Part-Arm LEDs will flash.

This put the Control Panel into Test mode.

PASSIVE INFRA RED (PIR) MOVEMENT DETECTORS

PIR detectors are designed to detect movement in a protected area by detecting changes in infra-red radiation levels caused for example when a person moves within or across the devices field of vision. If movement is detected an alarm signal will be generated, (if the system is armed). PIR detectors will also detect animals, so ensure that pets are not permitted access to areas fitted with Passive Infra Red Movement Detectors when the system is armed.

The Detector incorporates a tamper protection feature to protect against attempts to interfere with the device. If the battery cover is removed, an alarm will immediately occur at any time.

The Detector also incorporates a sensitivity adjustment feature to compensate for situations where the detector may be affected by environmental changes, (e.g. insects, air temperature, etc).

To conserve power and maximise battery life the PIR detector will only detect movement if there has been no movement detected within the previous 2 minutes.

The PIR Detector is powered by a PP3 Alkaline battery which under normal conditions will have an expected life in excess of 1 year. When the battery level drops, with the PIR in normal operation mode and the battery cover fitted, the LED behind the detection window will flash. When this occurs the battery should be replaced as soon as possible. (Note: in normal operation with the LED behind the lens will not flash on detection of movement).

Any number of PIR Movement Detectors can be used with your system, providing they are all coded with the system House Code and are mounted within effective radio range of the Solar Siren.

POSITIONING THE PIR MOVEMENT DETECTORS

The recommended position for a PIR Movement Detector is in the corner of a room mounted at a height between 2 and 2.5m. At this height, the detector will have a maximum range of up to 12m with a field of view of 110°.

The Position of the PCB inside the PIR can be set to 5 different positions to adjust the range of the detection

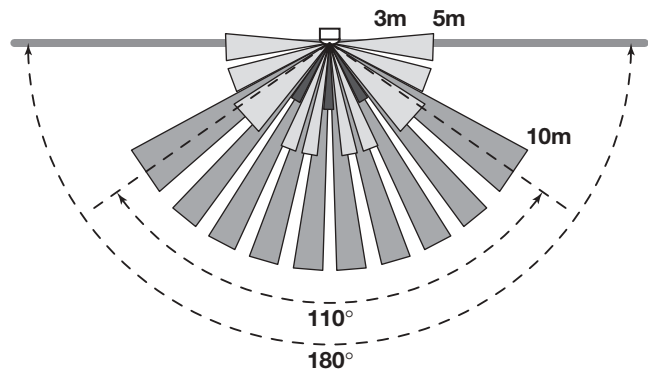
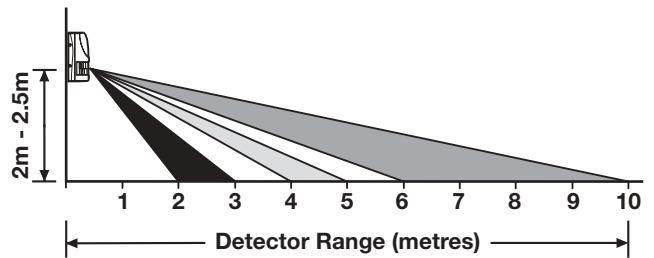

Detection Zone Pattern for PCB in position 5

pattern created by the PIR. Setting the PCB in position 3 will reduce the range to approximately 9m, with position 1 providing a range of approximately 6m. The recommended position setting for the PCB is in position 5.

When considering and deciding upon the mounting position for the detector the following points should be considered to ensure trouble free operation:

1. Do not position the detector facing a window or where it is exposed to or facing direct sunlight. PIR Movement Detectors are not suitable for use in conservatories.
2. Do not position the detector where it is exposed to draughts.
3. Do not position the detector directly above a heat source, (e.g. fire, radiator, boiler, etc).
4. Where possible, mount the detector in the corner of the room so that the logical path of an intruder would cut across the fan detection pattern. PIR detectors respond more effectively to movement across the device than to movement directly towards it.
5. Do not position the detector in a position where it is subject to excessive vibration.
6. Ensure that the position selected for the PIR detector is within effective range of the Control Panel, (refer to "Testing the Control Panel & Remote Control").

Note: When the system is Armed, pets should not be allowed into an area protected by a PIR Detector as their movement would trigger the PIR and trigger an alarm.

Note: DO NOT fix the detector to metalwork or locate the unit within 1m of metalwork (i.e. radiators, water pipes, etc) as this could affect the radio range of the Device.

INSTALLING AND CONFIGURING THE PIR MOVEMENT DETECTORS

Ensure that the system is in Test mode, (see page 17).

1. Undo and remove the fixing screw from the bottom edge of the PIR. Carefully pull the bottom edge of the detector away from the rear cover and then slide down to release the top clips.
2. Carefully drill out the required mounting holes in the rear cover using a 3mm drill according to whether the unit is being mounted in a corner or against a flat wall.

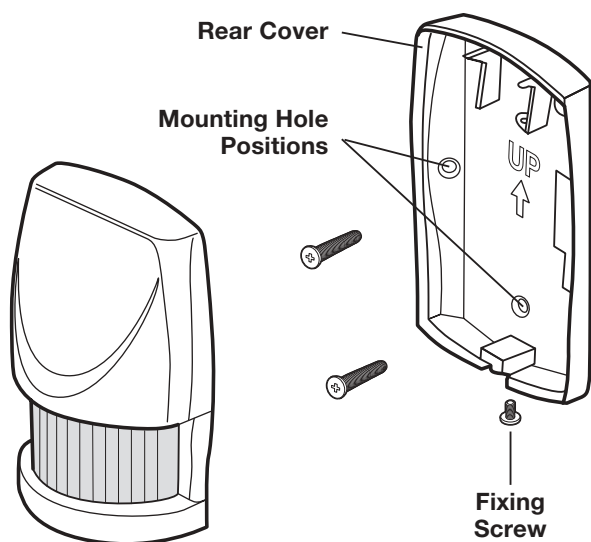

3. Using the rear cover as a template, mark the positions of the fixing holes on the wall.
4. Fix the rear cover to the wall using the two 18mm No.4 screws and 25mm wall plugs, (a 5mm hole will be required for the wall plugs). Do not over-tighten the fixing screws as this may distort or damage the cover.

Note: The wall plugs supplied with the product are not suitable for plasterboard walls, if mounting the Detector onto plasterboard use appropriate wall plugs.

5. Configure the House Code for the PIR Detector by setting DIP switches 1-8 of SW2 to the same ON/OFF combination as the House Code DIP switches in all other system devices.
6. Configure the alarm zone which the detector will operate on by setting DIP switches 1-3 of SW3 as follows:

	DIP 1	DIP 2	DIP 3
Zone 1	OFF	OFF	OFF
Zone 2	OFF	OFF	ON
Zone 3	OFF	ON	OFF
Zone 4	OFF	ON	ON
Zone 5	ON	OFF	OFF
Zone 6	ON	OFF	ON

e.g. To configure the detector to operate on Zone 3 set DIP switches 1, 2 and 3 of SW3 as follows:

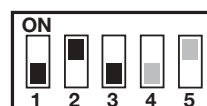

7. DIP 4 of SW3 is used to configure the PIR Detector for walk test mode, which allows the operation of the detector to be checked during installation without triggering a Full Alarm.

ON Walk Test mode
OFF Normal operation

Note: On initial installation the detector should be configured into Walk-Test mode ready for testing.

8. To select the required sensitivity, set DIP 5 of SW3 as follows:

ON HIGH sensitivity
OFF LOW sensitivity

Note: The recommended setting is HIGH. However, in cases of extreme environmental problems or if unexplained false alarms are experienced, it may be necessary to set the sensitivity to LOW. Setting the device to LOW sensitivity will require a greater amount of movement in order to trigger the device.

9. Connect the PP3 Alkaline battery to the battery clip. The LED behind the lens will rapidly flash for approximately 2-3 minutes until the PIR has stabilised. The LED will then stop flashing and turn OFF.

Note: If the device is configured in Walk Test mode (i.e. DIP 4 of SW3 ON) then the LED will flash upon detection of movement after the warm up period has expired.

10. Check that the detector PCB is located and set in the correct position to give the detection zone pattern required.

To adjust the PCB position simply slide it up or down ensuring that the location legs are aligned with the required position number marked on the board.

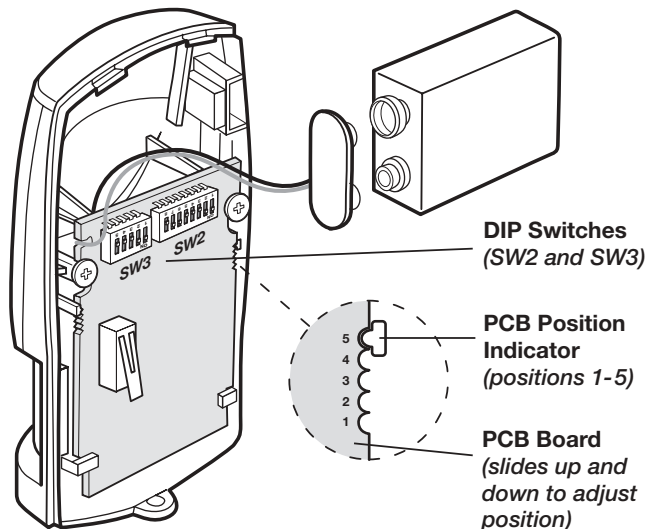

PCB Position	Range
1	6m
3	9m
5	12m

11. Refit the PIR detector to the rear cover by offering the detector up to the rear cover and locate the clips in the top edge into the rear cover. Push the lower edge of the detector into place and refit the fixing screw in the bottom edge of the PIR to secure in position. Do not over-tighten the fixing screws as this may damage the casing.

TESTING THE PIR MOVEMENT DETECTORS

Ensure that the system is in Test mode, (see page 17).

Ensure that the PIR is configured in Walk Test mode, (i.e. DIP 4 of SW3 ON) and mounted in position on the wall.

Allow 2-3 minutes for the detector to stabilise before commencing testing.

1. Put the Control Panel into "Walk Test" mode by pressing **1** on the Control Panel.

The Panel will beep and the Zone 1 LED will illuminate.

2. Walk into and move slowly around the protected area, each time the detector senses movement the

LED behind the lens will flash. In addition, the Control Panel will beep twice to indicate that the alarm signal has been received and the appropriate zone LED which the detector is configured for will illuminate.

If necessary re-adjust the detection pattern by changing the mounting position of the PCB within the PIR housing.

Note: In normal operation, the LED behind the PIR lens will not flash on movement detection, (unless the battery is low).

3. Press **ESC** on the Control Panel to exit Walk Test mode.

4. Reconfigure the PIR Detector into Normal operation mode and refit in position.

Note: When the detector is fully installed i.e. battery cover is refitted, to conserve power and maximise battery life the PIR detector will only detect movement if there has been no movement detected within the previous 2 minutes.

MAGNETIC CONTACT DETECTORS

The Magnetic Contact Detector comprises two parts; a Detector and a Magnet. They are designed to be fitted to either doors or windows with the Magnet screwed to the moving/opening part and the Detector screwed to the fixed door or window frame.

When the protected door or window is opened and the magnetic field from the Magnet moved away from the Detector an alarm signal will be generated, (if the system is armed).

The Magnetic Contact Detector has the facility to connect an additional wired Magnetic Contact. This must be of a normally closed contact type with the contact being opened in order to generate an alarm condition.

The Magnetic Contact Detector is powered by two CR2032 type Lithium cells which under normal conditions will have an expected life in excess of 1 year. Under normal battery conditions the LED on the Detector will not illuminate when the Detector is triggered, (unless in test mode). However, under low-battery conditions this LED will be illuminated for approx 1s when the detector is triggered. When this

occurs the batteries should be replaced as soon as possible.

Any number of Magnetic Contact Detectors can be used with the system, providing they are all coded with the system House Code and are mounted within effective radio range of the Solar Siren.

POSITIONING THE MAGNETIC CONTACT DETECTORS

The Magnetic Contact Detector is suitable for mounting in dry interior locations only.

Decide which doors and windows are to be protected by fitting Magnetic Contact Detectors, (usually the front and back doors as a minimum will have Magnetic Contact Detectors fitted). However additional detectors may be fitted where required to other more vulnerable doors or windows, (e.g. garage, patio/conservatory doors etc.).

Ensure that the position selected for the Magnetic Contact Detector is within effective range of the Control Panel, (refer to "Testing the Control Panel & Remote Control").

Note: Take care when fixing the Detector to a metal frame, or mounting within 1m of metalwork (i.e. radiators, water pipes, etc) as this could affect the radio range of the device. On uPVC Door/Window frames, it may be necessary to space the magnet and detector away from the metal surface using a plastic or wooden spacer to achieve the necessary radio range.

INSTALLING AND CONFIGURING THE MAGNETIC CONTACT DETECTORS

Ensure that the system is in Test mode, (see page 17).

1. Remove the battery cover by sliding and lifting it off. (DO NOT use a screwdriver to lever it off).

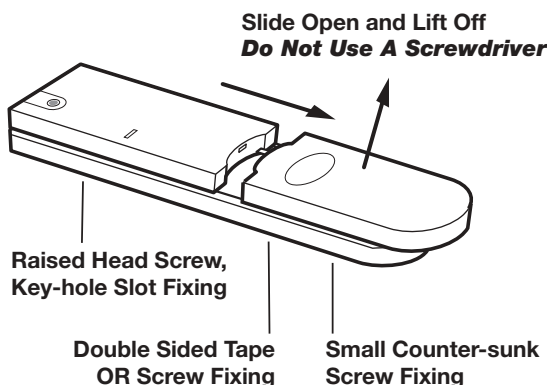

2. The detector and magnet should be mounted together along the opening edge of the Window/Door opposite the hinges. Ensure that the parallel gap between the magnet and detector is less than 10mm and that the arrow on the magnet is aligned with the mark on the detector.

The detector should be mounted on the fixed part of the frame and the magnet on the opening part.

(Ensure back surfaces are flush)

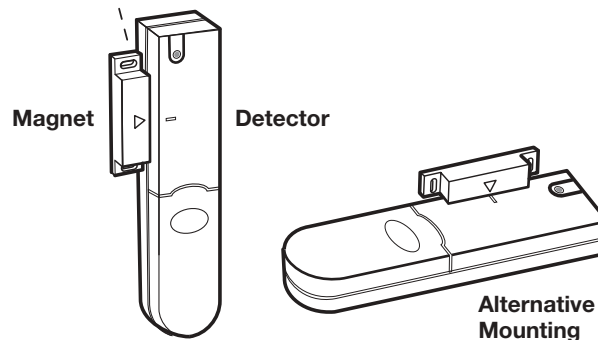

The detector and magnet should be mounted using the double sided adhesive pads or screws provided.

3. If fixing the detector with screws first remove the battery holder by carefully tilting up the end and pulling away from the printed circuit board.

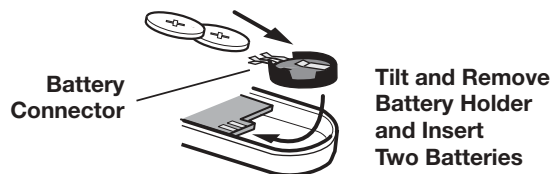

The top of the detector is secured with a keyhole slot over the head of the smaller pan head screw and the bottom of the detector is secured using the 12mm counter-sunk head screw fitted within the battery compartment. Carefully drill out the centre of the fixing screw hole in the battery compartment using a 3mm drill. Fit the magnet using the two 15mm fixing screws. Do not over tighten the fixing screws as this may distort or damage the casing.

4. If an additional wired Magnetic Contact is required, this should be wired to the terminal block provided in the battery compartment. The wired contact should be connected using two core (24AWG) wire of maximum length 1.5m. A cable entry cut-out is provided beside the terminal block in the battery cover.

If an additional wired contact is connected to the detector then jumper link S2 on the PCB must be removed.

IMPORTANT: If an additional wired contact is not connected, then the jumper link S2 must be fitted for the detector to operate correctly.

- Configure the House Code for the Magnetic Contact Detector by setting DIP switches 1-8 to the same ON/OFF combination as the House Code DIP switches in all other system devices.

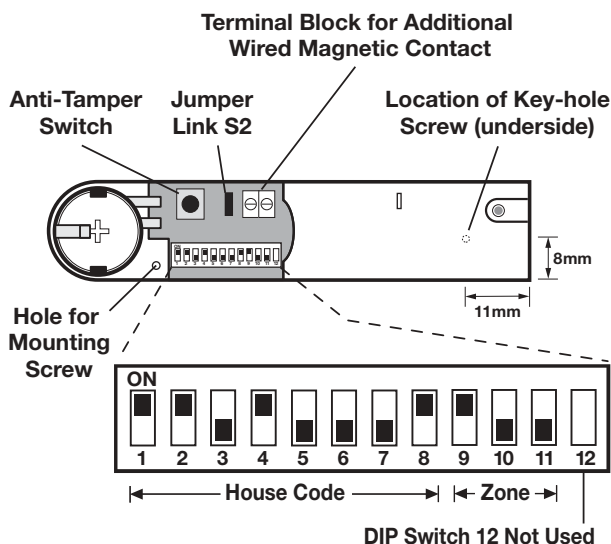

- Configure the alarm zone which the detector will operate on with DIP switches 9-11 as follows:

	DIP 9	DIP 10	DIP 11
Zone 1	OFF	OFF	OFF
Zone 2	OFF	OFF	ON
Zone 3	OFF	ON	OFF
Zone 4	OFF	ON	ON
Zone 5	ON	OFF	OFF
Zone 6	ON	OFF	ON

e.g. To configure the detector to operate on Zone 2 set DIP switches 9, 10 and 11 as follows:

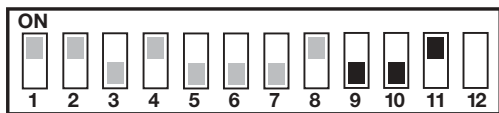

Note: DIP switch 12 is not used.

- Slide the two batteries supplied into the battery holder, ensuring that the positive (+) side is uppermost on each battery as it is installed.
- If necessary, refit the battery holder into the detector ensuring that the spring clip connectors slide onto either side of the circuit board.
- Refit the battery cover.

TESTING THE MAGNETIC CONTACT DETECTORS

Ensure that the system is in Test mode , (see page 17).

- Put the Control Panel into "Walk Test" mode by pressing on the Control Panel.

The Panel will beep and the Zone 1 LED will illuminate.

The LED on the Detector will illuminate for approx. 1s as the battery cover is removed and the tamper switch is activated. In addition, the Control Panel will beep twice to indicate that the alarm signal has been received and the Tamper LED will illuminate.

- Open the door/window to remove the magnet from the Detector.

As the magnet is moved away from the detector the LED will illuminate for approximately 1s to indicate that the Detector has been triggered. In addition, the Control Panel will beep twice to indicate that the alarm signal has been received and the appropriate zone LED, which the detector is configured for, will illuminate.

- If any external Magnetic Contact Sets are connected to the Detector, operate these one at a time. Each time a contact is opened the LED on the Detector should illuminate for 1s to indicate that it has been triggered.
- Replace the battery cover on the Detector.
- Press on the Control Panel to exit Walk Test mode.

EXTERNAL SOLAR SIREN

The Siren and Solar Panel are all encapsulated within a tough polycarbonate housing. This housing provides full protection against adverse weather conditions.

An LED indicator unit is built into the siren to act as a visible deterrent/indication that the system is active. The Indicator LEDs will slowly and alternately flash whether the system is Armed or Disarmed. During an alarm condition the Indicator LEDs will flash rapidly together.

An integral anti-tamper switch provides additional security protection to the Siren and will immediately

generate a full alarm should any unauthorised attempt be made to interfere with and remove the siren cover.

The Siren is powered by a high capacity 6V/1.2Ahr rechargeable sealed lead acid battery. A Solar Panel mounted on the top of the housing charges the battery during daylight hours. During darkness, only a small amount of energy is required to operate the Siren unit. A 9V Alkaline PP3 battery is supplied in the External Siren to boost the initial power to the unit when the system is first activated until the Solar Panel charges the main battery. (This battery is only designed to last for a short period until the main rechargeable battery has obtained sufficient charge).

The Siren unit incorporates the installations Jamming Detection system which will (if activated) generate an alarm if any attempt is made to continuously jam the radio channel used for the system.

POSITIONING THE SOLAR SIREN

The Siren should be located as high as possible in a prominent position so that it can be easily seen and heard. The Siren should be mounted on a sound flat surface so that the rear tamper switch is not activated when mounted. Ensure that the tamper switch does not fall into the recess between brick courses as this could prevent the switch from closing and give a permanent tamper signal.

In order to provide the maximum amount of daylight to the Solar Panel, the siren should ideally be mounted on a south facing wall. However, an easterly or westerly position will suffice.

Mounting the device on a north facing wall should be avoided as this could mean that during the short dark days of winter months the solar panel may not receive sufficient daylight in order to maintain the battery charge at acceptable levels.

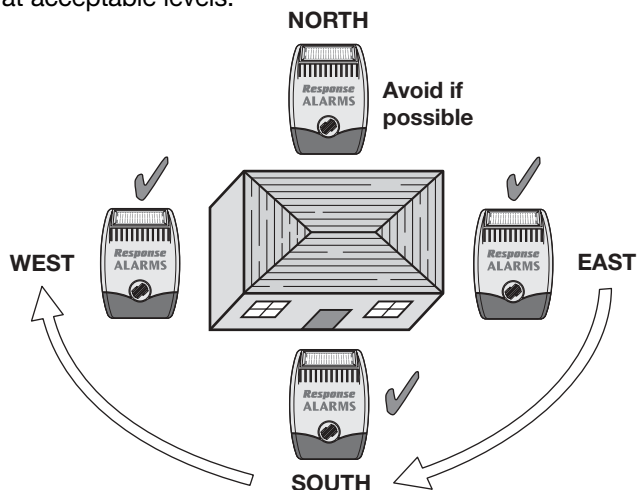

Shadows cast by neighbouring walls, trees and roof overhangs should also be avoided. If the Siren is to be mounted below the eaves, it should be positioned a distance of at least twice the width of the eaves overhang below the eaves. Remember that in winter the sun is lower in the sky and you should avoid winter shadows where possible.

The External Solar Siren contains a sophisticated radio receiver. However, reception of radio signals can be affected by the presence of metallic objects within the vicinity of the Solar Siren. It is therefore important to mount the Solar Siren a minimum distance of 1m away from any external or internal metalwork, (i.e. drainpipes, gutters, radiators, mirrors etc).

Ensure that the position selected for the Siren is within effective range of the Control Panel, (refer to "Testing the Control Panel & Remote Control").

INSTALLING AND CONFIGURING THE SOLAR SIREN

(See diagram overpage).

1. Remove the fixing screw from the bottom edge of the Siren housing and carefully hinge off the front cover. All electronic components are housed within the front cover.
2. Hold the mounting plate in position and mark the positions of the four mounting holes. A spirit level placed on the casing will ensure a perfect level.

Drill four 6mm holes and fit the wall plugs
3. Fit the two 30mm fixing screws in the top holes leaving approximately 10mm of the screw protruding.
4. Fit the top keyhole slots of the mounting plate over the screw heads. Remove the mounting plate and adjust the screws until they form a neat fit with the mounting plate with minimal movement.
5. Secure the mounting plate in position using the two 25mm fixing screws in the bottom fixing holes.
6. Ensure that the Solar Siren main configuration switch on the LED indicator board is set to "SIREN" for use with this alarm system.

Main Configuration Switch (in SIREN Position)



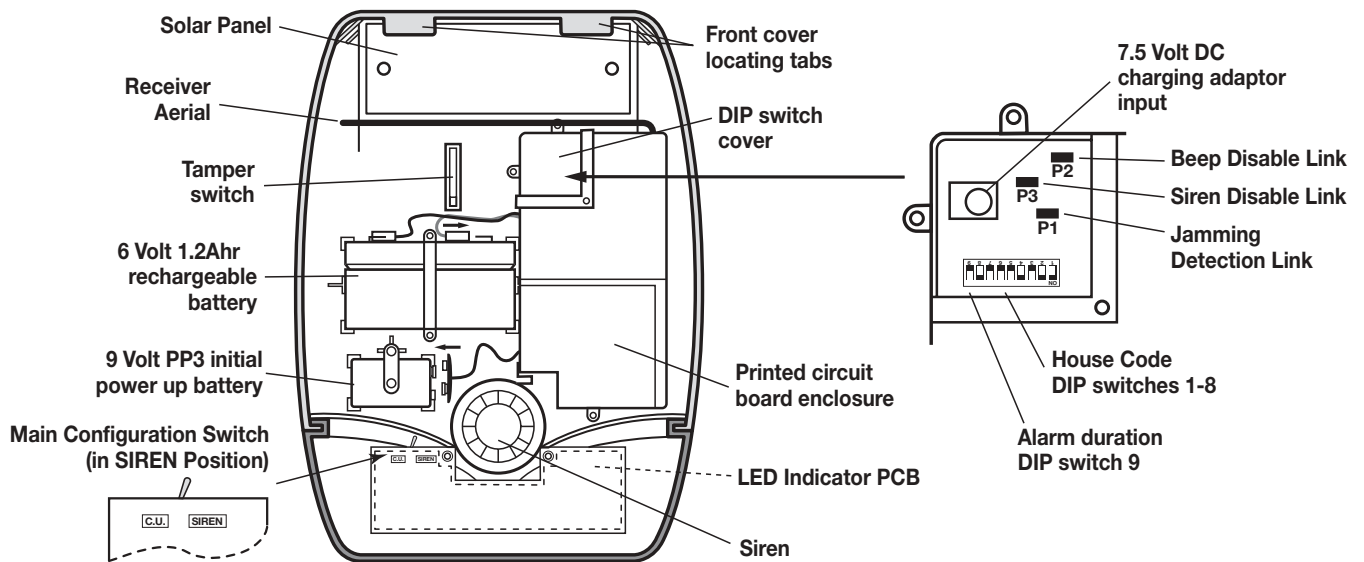

7. Undo the 3 screws holding the DIP Switch Cover in place and remove the cover.
8. Under the cover you will find a series of 9 DIP switches.

Note: When the Solar Siren is viewed as shown above (Solar panel at top) the DIP switches are 'upside down'.
9. DIP switches 1-8 are used to set the House Code for the Siren and must be set to the same ON/OFF combination as all other system devices.

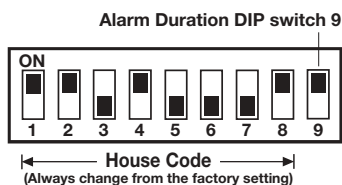

10. If required the maximum length of time that the External Solar Siren will sound for when activated under an alarm condition may be limited to 3 minutes using DIP switch 9 as follows:

ON	as Control Panel setting
OFF	3 minutes
11. The Solar Siren will acknowledge Disarm signals from the Remote Control and Service Mode signals by beeping. It is possible to disable these acknowledgement beeps if required by removing the jumper link P2 on the circuit board.

P2 fitted	beep enabled
P2 removed	beep disabled

12. If for any reason you need to disable the Siren, remove jumper link P3 on the circuit board. This will prevent the Siren from sounding during an alarm condition. However, the Siren will still beep

to acknowledge signals from the Remote Control, (provided the beep feature is not disabled).

P3 fitted	Siren enabled
P3 removed	Siren disabled

13. To enable the Jamming Detect feature in the Solar Siren fit the jumper link taped to the cover of the Siren control unit across link pins P1 on the circuit board.

P1 fitted	Jamming Detection enabled
P1 removed	Jamming Detection disabled

14. Refit the DIP switch cover and replace the three cover fixing screws. Do not over tighten the screw as this could damage the thread.

POWER-UP OF THE SOLAR SIREN

1. Connect the 9V PP3 initial power battery to the battery clip.



Connect the rechargeable battery to the charging leads. Connect the Red lead to the Red (+ve) terminal and the Black lead the Black (-ve) terminals. Both indicator LEDs will flash together in a single long flash to indicate that the unit is operational.

Important: Once the batteries have been connected, the Siren will be operational. It is important that the solar panel receives sufficient light to maintain the battery charge.

The Siren should not be operated repeatedly during installation and testing, as this will rapidly drain the battery. It is recommended that the Siren be left for at least 24 hours in order to charge the battery before the system is Armed and fully tested.

- Press the anti tamper switch, both indicator LEDs will flash together four times.
 - Hinge the front cover locating tabs over the top edge of the back plate and carefully push the base of the siren cover into place. Secure the Siren cover in place by refitting the fixing screw in the bottom edge of the cover. Do not over tighten the screw as this could damage the thread.
- Important:** Ensure that the rear tamper switch is closed when you fit the siren cover to the back-plate (i.e. listen for the switch to click). If the switch does not close this will prevent the Solar Siren from operating correctly. If necessary, remove the siren cover again and adjust the screw on the back-plate tamper plunger to ensure the switch closes when the Siren is secured in position.
- If fitted remove the protective film covering the Solar Panel.

TESTING THE SOLAR SIREN

- Press  on the Control Panel.
- The Control Panel alarm and Solar Siren will operate for a period of approximately 5 seconds with the Solar Siren switching ON and OFF a few seconds after the Control Panel.
- Zone LED 3 will be illuminated during the test.
- Note:** To stop the siren test before the 5s period has elapsed press  on the Control Panel.

EXTERNAL CONNECTIONS

The Control Unit incorporates a terminal block for connection of an external Hard-wired Siren. The connection terminal block is located inside the Control Panel behind the front cover.

To access the terminal block press



This puts the system into Test Mode and prevents an alarm occurring.

Undo the two fixing screws on the top edge of the Control Panel and open the front cover.

Before making any connections, ensure that the memory jumper link P1 is in the 'OFF' position and then remove the DC power jack and disconnect one of the back-up batteries.

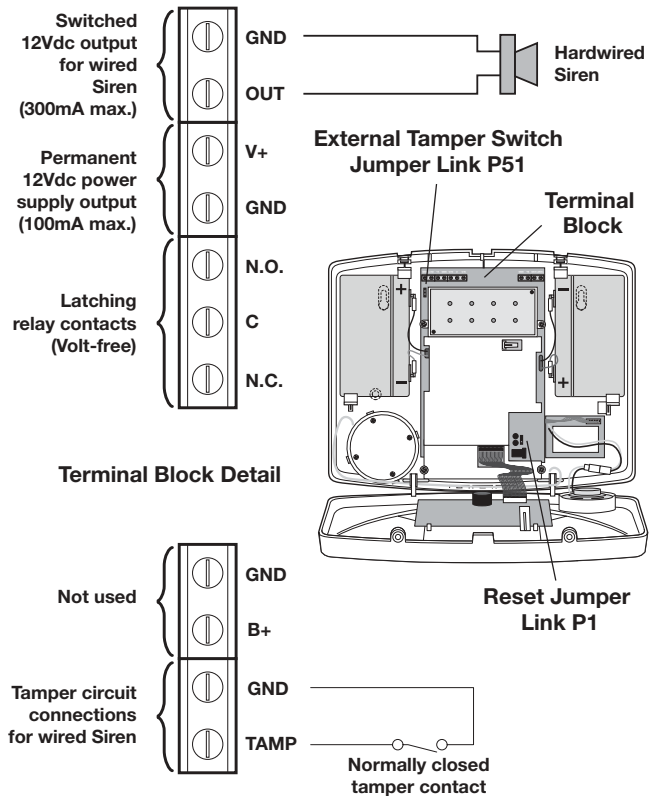

Note: Jumper link P51 should be fitted into the ON position only if the tamper circuit for a wired siren is used, otherwise it must be in the OFF position.

After making your external connections reconnect the power supply and back-up Battery. Then close the Control Panel cover and tighten the fixing screws on the top edge of the Control Panel.

Press  to leave Test mode and return to Standby.

TESTING THE SYSTEM

INITIAL TESTING

As the system is initially installed it is recommended that each device is tested in turn as it is installed, (refer to testing instructions for particular device).

TESTING AN INSTALLED SYSTEM

The Control Panel has a built in test facility to enable you to test the system at any time. However it is recommended that the system is tested at regular intervals not exceeding 3 months.

With the system in Standby Mode press



The Arm and Part-Arm LEDs will flash.

The system is now in the Test Mode

Note: After completing all required test functions press  to leave Test mode and return to Standby.

DETECTOR TEST

Before commencing testing please ensure that there is no movement in any PIR protected area, all doors/windows protected by Magnetic Contact Detectors are closed and that all battery covers are correctly fitted.

Press 

Zone LED 1 will illuminate.

Trigger each detector on the system by either walking into a PIR protected area or by opening a door/window protected by a Magnetic Contact detector. As each detector is triggered the Control Panel will beep and the LED of the zone which the detector is configured for will be illuminated. The Tamper switches of devices may also be tested in the same way in which case the Tamper Led on the Control Panel will be illuminated.

Note: To conserve power and maximise battery life the PIR detector will only detect movement if there has been no movement detected within the previous 2 minutes

Press  to exit detector test.

HARD-WIRED SIREN TEST

Press 

The internal relay driving the hardwired siren will be switched ON for a period of approximately 5 seconds. Zone LED 2 will be illuminated during the test.

SIREN TEST

Press 



The Control Panel alarm and the External Solar Siren will be operated for a period of approximately 5 seconds with the external Solar Siren switching ON and OFF a few seconds after the Control Panel.

Zone LED 3 will be illuminated during the test.

CONTROL PANEL LED TEST

Press 

Zone LED 4 will illuminate.

Use  and  buttons to scroll through and illuminate each LED in turn.

Press  to exit LED test.

SIREN SERVICE MODE

The Siren includes a Service Mode facility which prevents the sirens tamper switch from triggering the siren while it is removed from the wall for maintenance or to change the batteries. After changing the batteries and refitting in position, the Siren must be put back into normal Operating Mode, otherwise the siren will not sound in the event of an alarm condition.

Press  to switch the Siren between Service Mode and normal Operating Mode.

LED 5 will illuminate to show that the appropriate signal is being transmitted.

Service Mode: The Siren will produce two short beeps/LED flashes and then after approx 6s a single long beep/LED flash followed immediately by two short beeps/LED flashes to indicate that it has switched into service mode.

Operating Mode: After approx 6s the Siren will produce a single long beep/LED flash to indicate that it has switched into normal operating mode.

FACTORY DEFAULTS

User Access Code:	1 2 3 4
Alarm Duration:	3 minutes
Hardwired Siren:	Equal to Alarm Duration
Zone Operating Mode:	Intruder (all zones)
Part-Arm:	Zones 1-4: Enabled Zones 5-6: Disabled
Instant/Delay	Zone 1: Delay Zones 2-6: Instant
Entry/Exit Delay:	30s
Entry/Exit Warning Tone:	On
Zone Lockout	On
Jamming Detection:	Off

RESET FACTORY DEFAULT CONDITIONS

1. Press



This puts the system into Test Mode.

2. Undo the Control Panel cover fixing screws and open the cover.
3. Remove the DC power jack, then remove and disconnect one of the back-up batteries.
4. Set jumper link P1 to the ON position.

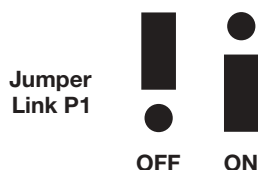

5. Reconnect the power supply jack.
6. The Control Panel will now reconfigure itself with all factory default settings.
7. Reconnect and replace the back-up battery.
8. Reset jumper link P1 into the OFF position.
9. Close the Control Panel cover and refit the fixing screws.

PROGRAMMING INSTRUCTIONS

With the system in Standby Mode with the Power LED ON.



The Arm and Part-Arm LEDs will illuminate and all Zone, Fire and tamper LEDs will flash.

The system is now in the Programming Mode

Note: After programming all required functions press to leave Programming mode and return to Standby.

USER ACCESS CODE

This allows the 4 digit user Access code to be changed to your own unique code which only you and other system users should be aware of.

Default setting: 1 2 3 4

To change the setting press ,

Zone LEDs 1-4 will illuminate.

Enter the new 4 digit User Access code. As each digit is entered, an illuminated zone LEDs will be turned OFF.

Press to save the new User Access code and return to programming mode, or

Press to return to programming mode without saving.

SYSTEM HOUSE CODE

This enables the system house code of the Control Panel to be configured.

Press ,

The current House Code setting will be displayed on the Zone, Fire and Tamper indicator LEDs. For example, a house code of 1101 0011, will be indicated as shown below:

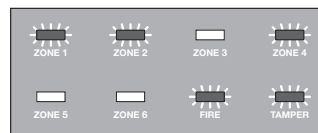

To change the setting:

a) At the Control Panel:

Press buttons 1-8 on the Control Panel to configure the LEDs so that they indicate the required house code. The LEDs will switch to the opposite state each time the corresponding button is pressed.

LED ON = 1, (House Code DIP Switch On/Up)

LED OFF = 0, (House Code DIP Switch Off/Down)

b) Using a Remote Control:

With the required House Code already configured, press the button on the Remote Control.

The Control Panel will beep twice to acknowledge the signal and the LED status will change to correspond with the House Code set on the Remote Control

Press to save the new User Access code and return to programming mode, or

Press to return to programming mode without saving.

INSTANT/DELAY ZONES

This defines which zones will operate in conjunction with the systems entry/exit delay period and which zones will instantly trigger an alarm when activated while the system is armed. Delay zones will not become active until the exit-delay has expired and when triggered will only initiate an alarm after the entry-delay has expired.

Default setting: zone 1: Delay, zones 2-6: Instant

Press  , 

The zone LEDs corresponding to the zones currently set to Delay will be illuminated. LEDs for zones set to Instant will be OFF.

LED ON	Delay Zone
LED OFF	Instant Zone

To change the setting:

Press the button corresponding to the zone number to be changed. The zones status will switch to the opposite state each time the button is pressed

Press  to save the new setting and return to programming mode, or

Press  to return to programming mode without saving.

ENTRY/EXIT DELAY

This allows the entry/exit delay period applied to 'Delayed' zones to be set. This has no effect on zones configured as 'Instant'

Default setting: 30 seconds

Press  , 

The zone LED corresponding to the current setting will illuminate.

0	no delay
1	10 seconds
2	20 seconds
3	30 seconds
4	40 seconds
5	50 seconds

To change the setting

Press the key corresponding to the required delay setting, the corresponding zone LED will illuminate as the setting is changed.

Press  to save the new setting and return to programming mode, or

Press  to return to programming mode without saving.

ALARM DURATION

This allows the alarm duration period (of the Control Panel, Wirefree Siren and Hardwired Siren) to be set as required.

Note: Following initiation of a Full Alarm condition the Siren will continue to sound until either the system is Disarmed; or the Alarm Duration Time expires. However, if the '3 minute alarm time limit' of the Solar Siren is enabled then the Solar Siren will shut down after 3 minutes even if the panel siren is still operating.

Default setting: 3 minutes

Press  , 

The zone LED corresponding to the current setting will illuminate.

0	no alarm
1	1 minute
2	2 minutes
3	3 minutes
4	5 minutes
5	10 minutes

To change the setting

Press the key corresponding to the required alarm period, the corresponding zone LED will illuminate as the setting is changed.

Note: When set to 'No alarm' the Siren will sound for approximately 10s if an alarm condition is initiated

Press  to save the new setting and return to programming mode, or

Press  to return to programming mode without saving.

PART-ARM

This controls which zones are operational when the Part-Arm feature is activated

Default setting: zones 1-4: Enabled
5-6: Disabled

Press  , 

The zone LEDs corresponding to the zones currently active during Part-Arm mode will be illuminated. LEDs for zones disabled during PART-ARM will be OFF.

LED ON	Zone enabled in Part-Arm
LED OFF	Zone disabled in Part-Arm

To change the setting

Press the button corresponding to the zone number to be changed. The zones status will switch to the opposite state each time the button is pressed.

Press  to save the new setting and return to programming mode, or

Press  to return to programming mode without saving.

ZONE LOCKOUT

This feature, if enabled, will only allow a single zone to trigger an alarm condition up to three times before the system is disarmed. However, if disabled there is no limit on the number of times a zone can trigger an alarm condition.

Default setting: ON

Press  , 

The zone 1 LED will illuminate to indicate the current Zone Lockout status.

LED ON	Zone Lockout enabled
LED OFF	Zone Lockout disabled

To change the setting

Press  .

The Zone Lockout status will switch to the opposite state each time the button is pressed.

Press  to save the new setting and return to programming mode, or

Press  to return to programming mode without saving.

ENTRY/EXIT WARNING TONE

This allows the warning beeps which are generated during the entry/exit delay to be switched ON or OFF as required.

Default setting: ON

Press  , 

The zone 1 LED will illuminate to indicate the current status of the Entry/Exit warning tone.

LED ON	Tone enabled
LED OFF	Tone disabled

To change the setting

Press  .

The warning tone status will switch to the opposite state each time the button is pressed.

Press  to save the new setting and return to programming mode, or

Press  to return to programming mode without saving.

JAMMING DETECTION

This allows the Control Panels anti-jamming detection facility to be switched ON or OFF as required. If enabled, the system will continuously scan for radio jamming signals on the systems operating frequency and trigger an alarm if jamming is detected.

Default setting: OFF

Press  , 

The zone 1 LED will illuminate to indicate the current Jamming Detector status.

LED ON	Jamming Detection enabled
LED OFF	Jamming Detection disabled

To change the setting

Press  .

The jamming detection status will switch to the opposite state each time the button is pressed.

Press  to save the new setting and return to programming mode, or

Press  to return to programming mode without saving.

Note: The jamming detection program setting will only control the jamming detection feature in the Control Panel. The jamming detection function incorporated in the Siren operates independently.

NO/NC RELAY CONTACTS

This setting controls the operation period for the NO/NC hardwired output relay contacts following an alarm condition being initiated. If this is set to 'ON Until Disarm' then the relay will latch and remain ON until the system is next disarmed.

Default setting: equal to Alarm Duration

Press  , 

The zone LED corresponding to the current setting will illuminate.

- | | |
|---|-------------------------|
| 1 | 2 seconds |
| 2 | 30 seconds |
| 3 | 1 minute |
| 4 | 3 minutes |
| 5 | 5 minutes |
| 6 | equal to Alarm Duration |

To change the setting

Press the key corresponding to the required activation period, the corresponding zone LED will illuminate as the setting is changed.

Press  to save the new setting and return to programming mode, or

Press  to return to programming mode without saving.

ZONE OPERATING MODES

Each alarm zone may be programmed to operate in one of 5 different modes dependant upon the type of alarm function it is required to perform.

Personal Attack

- used to provide 24 hour monitoring of any Personal Attack (PA) switches fitted to the system. Activation of any PA switch will immediately initiate a Full Alarm condition.

Intruder

- provides standard intruder monitoring with normal ARM and PART-ARM functions.

24 Hour Intruder

- used to provide 24 hour monitoring of areas requiring continuous security protection even while the system is Disarmed, (e.g. gun lockers). Activation of any detector on a security zone will

immediately initiate a Full Alarm condition.

Fire

- use to provide 24 hour monitoring of any Fire/Smoke detectors fitted to the system. Activation of any detector will immediately initiate a Full Alarm condition.

Test

- when the system is armed, any detector on the zone will cause the appropriate zone LED on the Control Panel to flash without initiating a Full Alarm condition.

Note: Personal Attack, 24 Hour Intruder and Fire modes all operate on a 24 hour basis, (i.e. they are able to initiate Full Alarm condition at any time irrespective of whether the system is Armed or Disarmed).

Default setting: all zones mode 2 (Intruder).

Press  ,  to configure zone 1

Press  ,  to configure zone 2

Press  ,  to configure zone 3

Press  ,  to configure zone 4

Press  ,  to configure zone 5

Press  ,  to configure zone 6

The zone LED corresponding to the current operating mode will illuminate.

Zone 1 LED	Personal Attack (PA)
Zone 2 LED	Intruder
Zone 3 LED	24 Hour Intruder
Zone 4 LED	Fire
Zone 5 LED	Test

To change the setting

Press the key corresponding to the required zone operating mode, the corresponding zone LED will illuminate as the setting is changed.

Press  to save the new setting and return to programming mode, or

Press  to return to programming mode without saving.

OPERATING INSTRUCTIONS

When leaving the premises, the system must be Armed. However, before doing so, check that all windows are closed and locked, all protected doors are closed and PIR Movement Detectors are not obstructed. Ensure that pets are restricted to areas not protected by PIR Movement Detectors.

The system has two armed modes, ARM and PART-ARM. The Part-Arm facility allows for selected zones to be left in a Disarmed state whilst the remainder of the system is Armed.

When the system is Armed (in either mode) the Zone LEDs for all active zones will illuminate for a few seconds, in addition the appropriate Arming Mode LED will flash. All active zones set as INSTANT will immediately be Armed and able to trigger an alarm. If enabled the system exit-delay will start and the Control Panel will start beeping, (the beep rate increasing in steps as the delay period expires). When the exit-delay expires all active zones set to 'Delay' will be Armed and able to trigger an alarm. By this time the user must have left the property and closed the final protected door.

If while the system is armed a detector on an INSTANT zone is triggered then this will immediately initiate a Full Alarm condition with both Control Panel and Siren sounding. However if a detector on a DELAY zone is triggered, the entry-delay (if enabled) will start and the Control Panel will start beeping with the beep rate increasing in steps as the delay expires. If the system has not been Disarmed when the entry-delay period expires a Full Alarm condition will occur. When a Full Alarm condition occurs the LED corresponding to the zone that triggered the alarm will flash.

At the end of the programmed alarm duration the Siren and Control Panel alarms will stop and the system will automatically re-Arm itself, (subject to the conditions of the Zone Lockout feature).

- Notes:**
- To conserve power and maximise battery life the PIR detector will only detect movement if there has been no movement detected within the previous 2 minutes.
 - If the External Solar Siren is fitted and the 3 minute limit is enabled then the external siren will shut down when the programmed

alarm duration expires or after 3 minutes, whichever occurs first.

ARMING THE SYSTEM

The system can be set in FULL ARM mode using either the Remote Control or the Control Panel as follows:

- Press  on the Remote Control, or,
- Press



on the Control Panel.

PART-ARMING THE SYSTEM

The system can be set in PART-ARM mode using either the Remote Control or the Control Panel as follows:

- Press  on the Remote Control, or,
- Press



on the Control Panel.

DISARMING THE SYSTEM

The system can be set in PART-ARM mode using either the Remote Control or the Control Panel as follows:

- Press  on the Remote Control, or,
- Press



on the Control Panel.

If the system has been triggered and an alarm condition has occurred, then the appropriate LED will be illuminated to indicate which zone(s) have triggered the alarm. Make a note of the zone(s) indicated to assist in tracing the cause of the alarm, before pressing  to clear the indication and return the system to Standby.

Note: If the system is Disarmed with the Remote Control the Siren will beep twice, (unless the warning beeps have been disabled on the Siren).

PERSONAL ATTACK (PA) ALARM

A full Alarm condition can be immediately initiated at any time (whether the system is Armed or Disarmed) in the event of threat or danger by activating a Personal Attack (PA) switch on either the Remote Control or the Control Panel as follows:

- a) Slide the Personal Attack switch on the Remote Control upwards, or
- b) Press and hold the  button for approximately 3 seconds on the Control Panel.

The alarm will continue either for the alarm duration when the system will automatically reset or until the system is disarmed.

TAMPER

If the battery cover of any device (except a Remote Control) is removed or if the Siren or Control Panel are removed from the wall then a Full Alarm condition will be initiated even if the system is Disarmed. The alarm condition will continue either for the alarm duration when the system will automatically reset or until the system is Disarmed. The Tamper LED on the Control Panel will flash to indicate the Tamper Alarm has been activated.

Note: The Tamper protection facility on the Siren operates independently of the Control Panel. If the Tamper on the Siren is activated this will not be indicated at the Control Panel.

SIREN SERVICE MODE

In order to remove the Solar Siren from the wall to change the batteries. It is necessary to place the Siren into Service mode to prevent the Tamper protection switch on the Siren operating and triggering an alarm. When you have completed any alterations to the system remember to switch the siren back into Operating Mode.

The siren can be switched into service mode using either the Remote Control, Control Panel as follows:

Remote Control:

Press and hold the  button for approximately 6 seconds.

The Siren will produce two short beeps as the button is pressed followed by a single long beep approximately 6 seconds later to indicate that it has switched into service mode.

Control Panel:

With the system in Standby Mode:

Press



to enter Test mode, the Arm and Part-Arm LEDs will flash.

Press  to switch the Siren between Service Mode and normal Operating Mode. LED 5 will illuminate to show that the appropriate signal is being transmitted.

The Siren will produce two short beeps as the button is pressed followed by a single long beep approximately 6 seconds later to indicate that it has switched into service mode.

Press  to return to Standby mode.

SIREN OPERATING MODE

The siren can be switched back into operating mode using either the Remote Control, Control Panel as follows:

Remote Control:

Press and hold the  button for approximately 6 seconds.

After approximately 6 seconds the Siren will produce a single long beep to indicate that it has switched into operating mode in a Disarmed state. The button should be released during or immediately after the long beep, otherwise the system will switch into an Armed state.

Control Panel:

With the system in Standby Mode:

Press



to enter Test mode, the Arm and Part-Arm LEDs will flash.

Press  to switch the Siren between Service Mode and normal Operating Mode. LED 5 will illuminate to show that the appropriate signal is being transmitted.

After approximately 6 seconds the Siren will produce a single long beep to indicate that it has switched into operating mode in a Disarmed state.

Press  to return to Standby mode.

After approximately 6 seconds the Siren will produce a single long beep to indicate that it has switched into operating mode in a Disarmed state. The Arm button should be released during or immediately after the long beep, otherwise the system will switch into an Armed state.

BATTERY MONITORING

All system devices continuously monitor their battery condition. If the battery level of any device drops below acceptable levels then its low battery indication will be activated.

In addition if any PIR or Magnetic Contact detector has a low battery status it will be indicated on the 'LOW BAT' LED on the Control Panel.

LED ON	Magnetic Contact
LED Flashing	PIR

When a low battery indicator is activated the device will continue to operate normally for up to 2 weeks (depending upon system use). However, the battery for that device should be replaced as soon as possible.

Note: Before removing the battery cover on any device to replace the battery ensure that the system is put into Test mode to avoid initiating a Full Alarm condition.

The low battery indication for each system component is as follows:

Remote Control

When the Remote Control is operated under low-battery conditions the transmit LED will continue to flash after the button has been released.

Under normal battery conditions the LED will extinguish within 2s of the button being released.

PIR Movement Detector

If the voltage level of any PIR battery falls below approx. 7.5V, the LED behind the detector lens will flash when movement is detected to indicate that the battery needs to be replaced.

Under normal battery conditions the LED does not illuminate unless the PIR detector is in Walk Test mode.

Magnetic Contact Detector

Under low battery conditions, when the Detector is activated, the transmit LED will be illuminated for approximately 1s as the door/window is opened.

Under normal battery conditions the LED will not illuminate as the Detector is operated, (unless the Detector is in Test Mode with the battery cover removed).

MAINTENANCE

Your Alarm System requires very little maintenance. However, a few simple tasks will ensure its continued reliability and operation.

Important: Should you, for any reason, have to completely power-down the system (e.g. to move the system to a new premises) the Solar Siren must be switched into Service mode and the Control Panel must then be placed in Test mode before either device can be opened and the power disconnected before being removed from the wall. Ensure that the solar panel is covered with a light proof material to prevent it being energised.

SOLAR SIREN

1. It is recommended that the Solar Panel on the top of the siren housing should be cleaned at least twice a year, preferably in the Spring and Autumn, using a soft damp cloth. Do not use abrasive, solvent based or aerosol cleaners. Do not attempt to clean inside the unit or allow water to enter the unit.

This will ensure that the Solar Panel does not become affected by the build up of excessive dirt and receives all the available light.
2. The Solar Siren should not be left for long periods with the batteries connected, unless the unit is able to receive sufficient light to maintain the battery charge. Failure to maintain charge to the unit will result in the rechargeable battery running unacceptably low. Should this occur, the unit must be recharged from a 7.5Vdc/100mA supply (e.g. from a mains adaptor power supply). When re-powering the Solar Siren fit a new 9V PP3 leak proof Alkaline power-up battery to ensure that the Unit receives sufficient power until the solar panel can recharge the main battery.
3. The main rechargeable battery has a typical life of 3-4 years and needs no maintenance during this period, provided the battery is kept charged. The battery will be damaged if it is stored in a discharged state for long periods.

Note: Before removing the Solar Siren from the wall in order to replace the batteries or for any other reason ensure that the Siren is first switched into Service Mode to prevent the Siren's Tamper switch operating and triggering an alarm, (see page 24).

Important: After changing the batteries and refitting in position, the Siren must be put back into normal Operating Mode, otherwise the siren will not sound in the event of an alarm condition.

CONTROL PANEL

The rechargeable batteries have a typical life in excess of 3 to 4 years and need no maintenance during this period, provided they are kept charged. The batteries will be damaged if they are stored in a discharged state for long periods.

DETECTORS AND REMOTE CONTROL

The Detectors require very little maintenance. The batteries should be replaced once a year or when a low battery status is indicated.

BATTERIES

Note: Before removing the battery cover on any device to replace the battery ensure that the siren is switched into Service mode to avoid initiating a Full Alarm condition.

The specifications for replacement batteries are as follows:

Remote Controls:	1 x 3V CR2032 Lithium Cells (or equivalent)
Magnetic Contact Detectors:	2 x 3V CR2032 Lithium Cells (or equivalent)
PIR Movement Detectors:	1 x 9V PP3 Alkaline
Keypad:	1 x 9V PP3 Alkaline

Note: Where applicable only fit PP3 Alkaline type batteries. Rechargeable batteries should NOT be fitted.

At the end of their useful life the batteries should be disposed of via a suitable Recycling Centre. Do not dispose of with your normal household waste. DO NOT BURN.

The Rechargeable Batteries contain Sulphuric Acid - DO NOT ATTEMPT TO OPEN THE CASING.



ALARM RECORD

Complete the following information during installation for future reference when adding to your system and to assist Trouble Shooting Zone Settings.

Zone	Detector(s)	Location	Zone Settings			
			Zone Operating Mode	Instant / Delay	Arm	Part-Arm
1						
2						
3						
4						
5						
6						

You may make a note of your User Access Code and System House Code below.

User Access Code

System House Code

ON	□	□	□	□	□	□	□
	1	2	3	4	5	6	7



e.g.

= ON = 1
 = OFF = 0

Use this diagram to record your House Code

This information is confidential and should be kept in a safe location.

TROUBLE SHOOTING

Symptom / Recommendation	Symptom / Recommendation
<p>Control Unit not working – Power LED OFF or flashing.</p> <ol style="list-style-type: none"> 1. Mains power failure - check if other electrical circuits are operable. 2. Check that mains adaptor is plugged in and socket is switched ON. 3. Check that DC jack plug from mains adaptor is connected in Control Panel. 4. Check fuse/MCB in Consumer Unit on the circuit serving the Control Panel. <p>Note: Before replacing any fuses or resetting the MCB, the cause of the failure should be investigated and rectified.</p>	<p>Detection Zone triggered (LED flashing) but no alarm is sounding.</p> <ol style="list-style-type: none"> 1. Entry/Exit delay still running and not yet expired. 2. Alarm duration period has already expired and system has reset. 3. Alarm duration programmed to "no alarm".
<p>Control Unit "Low Battery" LED flashing.</p> <ol style="list-style-type: none"> 1. Check all PIR movement Detectors for low battery indication, (i.e. LED behind detection lens flashes when movement detected). Renew batteries as required and press  to clear 'Low Batt' LED on panel. 	<p>Siren and Strobe operating but no alarm at Control Panel.</p> <ol style="list-style-type: none"> 1. Siren Tamper switch activated. Check security of Siren fixing to wall and adjustment of anti-tamper switch to ensure switch is fully depressed. 2. Siren Jamming detection circuit operated, (jamming detection at Control Panel disabled).
<p>Control Unit "Low Battery" LED illuminated.</p> <ol style="list-style-type: none"> 1. Check all Magnetic Contact Detectors for low battery indication, (i.e. LED on Detector body illuminates for 1s when detector triggered). Renew batteries as required and press  to clear 'Low Batt' LED on panel. 	<p>Siren not responding to Control Panel.</p> <ol style="list-style-type: none"> 1. Ensure 'House Code' is correctly set to the same code as all other system devices. 2. Ensure main Siren configuration switch is set to SIREN. 3. Incorrect User Access code being entered at Control Panel. 4. Ensure Siren is within effective radio range of Control Panel and equipment is not mounted close to metal objects. 5. Siren rechargeable battery discharged <ol style="list-style-type: none"> a. Clean Solar Panel. b. Check age of rechargeable battery – replace if at end of useful life. c. Fit new initial power-up battery and re-power up siren. 6. Siren Disable link removed – refit link to enable siren.
<p>Control Unit not accepting User Access code.</p> <ol style="list-style-type: none"> 1. Pause between key depressions too long. Do not pause for more than 5 seconds between pressing keys. 2. Incorrect code entered. Allow 5 seconds to elapse before re-entering correct code. 3. Reset to factory defaults and reprogram system. 	<p>Full Alarm Condition occurs when system has not been triggered by an intruder or is disarmed.</p> <ol style="list-style-type: none"> 1. Tamper switch activation <ol style="list-style-type: none"> a. check all detector battery covers to ensure correctly fitted. b. check Control Panel and Siren are securely mounted to the wall and tamper switch is closed. 2. Personal Attack Alarm operated from a Remote Control or Control Panel. 3. Jamming detection circuit operated.
<p>Siren not responding to detector.</p> <ol style="list-style-type: none"> 1. Detector battery low - Replace battery. 2. Siren in Service Mode – switch back to operating mode using Remote Control or keypad. 3. Ensure 'House Code' is correctly set to the same code as all other system devices. 4. Ensure detector is within effective radio range of Siren and equipment is not mounted close to metal objects. 	

TROUBLE SHOOTING - continued

Symptom / Recommendation	Symptom / Recommendation
<p>LED on Remote Control not illuminating, or is dim when unit is operated.</p> <ol style="list-style-type: none"> 1. Ensure battery is fitted with correct polarity. 2. Ensure battery holder connections are making good contact with the battery. 3. Battery flat - replace battery. 	<p>Magnetic Contact Detector not working.</p> <ol style="list-style-type: none"> 1. Ensure that magnet is correctly positioned in relation to detector and that the gap between magnet and detector is not too large. 2. Ensure TWO batteries are fitted with correct polarity. 3. Ensure battery holder connections are making good contact with the batteries and PCB. 4. Ensure 'House Code' is correctly set to the same code as all other system devices. 5. Ensure DIP switches 9, 10 and 11 are correctly set, (i.e. 9=ON, 10=ON, and 11=OFF). 6. If there is no additional Magnetic Contact Detector connected ensure jumper link is fitted. 7. If an additional Magnetic Contact Detector is connected: <ol style="list-style-type: none"> a. Ensure jumper link is removed. b. Check that both contacts are closed. c. Check that additional contact is correctly wired. <p>Note: If an additional contact is used then the doors/windows protected by both the main wirefree detector and the additional wired detector must be closed when either is opened. If one of the doors/windows is already open then the opening of the other door/window will not be detected.</p> <ol style="list-style-type: none"> 7. Ensure detector is within effective radio range of Control Panel and is not mounted close to metal objects which may interfere with RF transmission
<p>PIR Movement Detector false alarming.</p> <ol style="list-style-type: none"> 1. Ensure that the detector is not pointing at a source of heat or a moving object. 2. Ensure that the detector is not mounted above a radiator or heater. 3. Ensure that the detector is not facing a window or in direct sunlight. 4. Ensure that the detector is not in a draughty area. 5. Sensitivity too HIGH – reset to LOW sensitivity. 	<p>Magnetic Contact Detector false alarming</p> <ol style="list-style-type: none"> 1. Ensure that magnet is correctly positioned in relation to detector . 2. Ensure that gap between magnet and detector is less than 10mm. 3. Tamper switch below battery cover not depressed - check battery cover is fitted correctly and that fixing lugs are not broken.
<p>PIR Movement Detector not detecting a person's movement.</p> <ol style="list-style-type: none"> 1. Ensure the battery clip is securely connected. 2. Ensure 'House Code' is correctly set to the same code as all other system devices. 3. Sensitivity too LOW – reset to HIGH sensitivity. 4. Ensure DIP switches 1, 2 and 3 of SW2 are correctly set, (i.e. 1=ON, 2=ON, and 3=OFF). 5. Ensure that detector is mounted the correct way up, (i.e. with detection window at the bottom). 6. Ensure that the detector is mounted at the correct height, (i.e. 2-2.5m). 7. Allow 2-3 minutes for detector to stabilize and become fully operational. Leave the area for this period. 8. Ensure detector is within effective radio range of the siren and is not mounted close to metal objects which may interfere with RF transmission. 	<p>LED on Magnetic Contact Detector illuminating when door or window is opened</p> <ol style="list-style-type: none"> 1. Low battery - replace Batteries.
<p>PIR Movement Detector LED flashes on detection of movement, (device in normal operation mode).</p> <ol style="list-style-type: none"> 1. Ensure that the detector is configured for normal operation, (i.e. DIP switch 4 of SW2 is OFF). 2. Low battery - replace battery. 	

OPERATION

<p>HELPLINE If you have a problem with your alarm, please call the helpline on:</p>	<p>01268 563273 (Lines open 9.00am to 5.00pm, Monday to Friday)</p>
--	--

EXTENDING YOUR ALARM SYSTEM

Your system may be extended to provide additional protection by adding additional PIR Movement Detectors, Magnetic Contact Sets and Remote Control Units.

ACCESSORIES

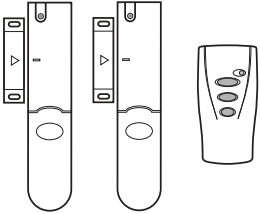
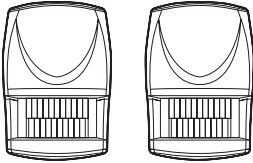
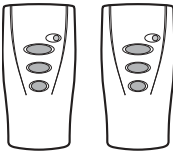
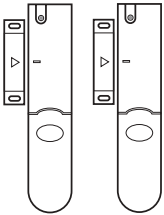
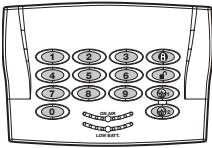
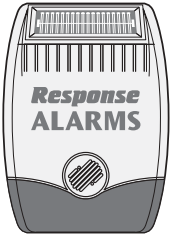
 <p>SU1 - ACCESSORY SET 2 x Magnetic Contact Detectors and 1 x Remote Control Unit.</p>	 <p>SU2 - PIR MOVEMENT DETECTORS 2 x PIR Movement Detectors.</p>	 <p>SU3 - REMOTE CONTROL UNITS 2 x Remote Control Units.</p>
 <p>SU4 - MAGNETIC CONTACT DETECTORS 2 x Magnetic Contact Detectors.</p>	 <p>SU5 - REMOTE KEYPAD 1 x Remote Keypad.</p>	 <p>SU6 - EXTERNAL SOLAR SIREN 1 x External Solar Siren.</p>

GUARANTEE

Novar ED&S undertakes to replace or repair at its discretion goods (excluding non rechargeable batteries) should they become defective within 1 year solely as a result of faulty materials and workmanship.

Understandably if the product has not been installed, operated or maintained in accordance with the instructions, has not been used appropriately or if any attempt has been made to rectify, dismantle or alter the product in any way the guarantee will be invalidated.

The guarantee states Novar ED&S entire liability. It does not extend to cover consequential loss or damage or installation costs arising from the defective product. This guarantee does not in any way affect the statutory or other rights of a consumer and applies to products installed within the UK and Eire only.

If an item develops a fault, the product must be returned to the point of sale with:

1. Proof of purchase.
2. A full description of the fault.
3. All relevant batteries (disconnected).

Friedland is a trade mark of Novar ED&S.

Friedland, Novar Electrical Devices and Systems.

The Arnold Centre, Paycocke Road, Basildon, Essex. SS14 3EA.

Novar Electrical Devices and Systems are Quality Assurance Registered to BS EN ISO9001:2000, by Asta

External Solar Siren

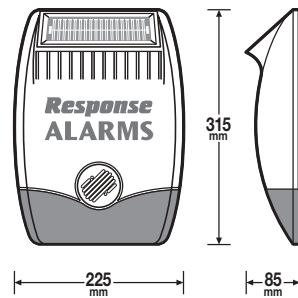

- RF operating frequency: 433MHz
- Sealed lead acid battery 6V/1.2Ahr
- Solar Panel 7.5V - Charge Rate typically 60mA
- Operation time in complete darkness – up to 25 days
- 95dB Piezo Siren
- 3 minute alarm duration limiter (optional)
- Auto reset
- Siren Disable (selectable)
- Dual front and rear anti-tamper protection
- Jamming Detection
- Audible confirmation

Remote Control

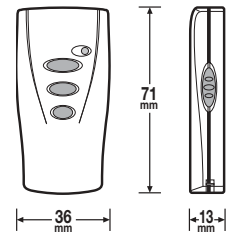

- RF operating frequency: 433MHz
- Range: 50m max.
- Personal Attack (PA) switch
- Operates all ARM, PART-ARM and DISARM functions
- Transmission indicator
- Battery life > 1 year
- Low battery indicator

Keypad

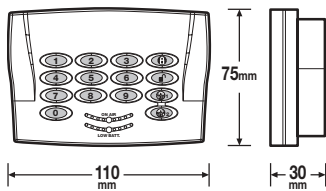

- RF operating frequency: 433MHz
- Range: 50m max.
- Changeable 4 digit User Access code.
- Anti-Tamper protected
- Personal Attack (PA) facility
- Battery Life > 1 year
- Low Battery Indicator

Passive Infra-Red Movement Detector

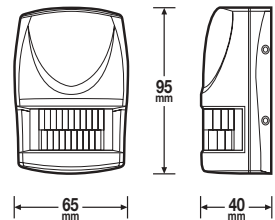

- RF operating frequency: 433MHz
- Range: 75m max.
- Detection range: up to 12m at 110°
- Walk test facility
- High/Low movement sensitivity settings
- Anti-Tamper protected
- Corner or surface mount
- Battery Life > 1 year
- Low Battery Indicator

Control Panel

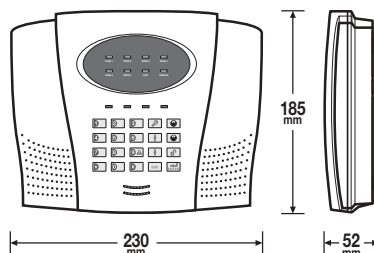

- RF operating frequency: 433MHz
- Range: 50m
- Battery Back-up
- Detector Battery Status Indication
- 6 Zones
- Part-Arm Facility
- Instant or Delayed Alarm Zones
- Entry/Exit Delay alarm mode
- Entry/Exit Delay Warning (selectable)
- 90dB High Power Piezo Siren
- Connections for Hardwired Siren and Auto Dialler
- Programmable 4 digit User Access Code
- Programmable Alarm Duration
- Programmable Entry/Exit Delay
- Auto Reset
- Zone Lockout
- Siren Disable (selectable)
- Dual front and rear anti-tamper
- Personal Attack (PA)
- Jamming Detection
- Low Battery Indicator

Magnetic Contact Detector

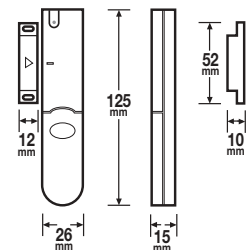

- RF operating frequency: 433MHz
- Range: 75m max.
- Test Mode
- Anti-Tamper protection
- Facility to add external wired Magnetic Contact Detector or Personal Attack buttons
- Battery Life >1 year
- Low Battery Indicator

RESEARCH & DEVELOPMENT

Our R & D Department is constantly developing new products.

We practice a policy of continued improvement and reserve the right to change specifications without prior notice.

If you have a problem with your Alarm, please call the Helpline on:

01268 563273

(Lines open 9.00am to 5.00pm, Monday to Friday).



Friedland, Novar Electrical Devices and Systems.
The Arnold Centre, Paycocke Road, Basildon, Essex SS14 3EA. UK.