

EASYHOME

INSTALLATION AND OPERATING MANUAL



VIDEO INTERCOM

WIRELESS TWO-WAY SYSTEM

EC DECLARATION OF CONFORMITY

DoP N°: EM0013

Applicable Products: ERA - HomeGuard
ERA - HomeGuard Pro

ERA Home Security Ltd

Valiant Way
Wolverhampton
WV9 5GB
United Kingdom

Tel: +44(0) 1922 490 000

Fax: +44(0) 1922 494 420

The products described above are in conformity with the Radio Equipment Directive 2014/53/EU.

Standards: Control Unit EN 301 489-1 V2.1.1: 2017/ EN 300 220-1 V3.1.1 2017
EN 62368-1: 2014/ EN 62311:2008
EN 301 489-3 V2.1.1 2017/ EN 300 220-2 V3.1.1 2017
EN 301 511 v12.5.1:2017/ EN 301 489-52 v1.1.0: 2016
EN 300 328 V2.1.1: 2016/ EN 301 489-17 V3.1.1: 2017

Standards: Door Sensor EN 301 489-1 V2.1.1: 2017/ EN 301 489-3 V2.1.1: 2017
EN 300 220-1 V3.1.1 2017/ EN 300 220-2 V3.1.1: 2017
EN 62479: 2010/ EN 62368-1: 2014

**Standards: PIR Sensor
& Remote Control** EN 301 489-1 V2.1.1: 2017/ EN 300 220-1 V3.1.1: 2017
EN 301 489-3 V2.1.1: 2017/ EN 300 220-2 V3.1.1: 2017
EN 62479: 2010/ EN 62368-1: 2014

Signed for and on behalf of **ERA Home Security Ltd:**

Ben Penson:
Technical & Quality Director
29/09/2017



IMPORTANT

PLEASE READ THIS MANUAL CAREFULLY BEFORE OPERATING THE SYSTEM AND RETAIN FOR FUTURE REFERENCE.

All devices, with the exception of the external siren are suitable for mounting in dry interior locations only.

Any repairs must be carried out by an Authorised Repair Centre. Misuse or attempted repairs to a component part of the product will invalidate the warranty. The photocopying, copying, reproduction, translation to any language, modification, storage in a retrieval system or retransmission, in whole or in part, in any form or by any means, electronic, mechanical or otherwise of this manual, is strictly prohibited without the prior written permission of ERA Home Security.

Disposal and Recycling

Disposal of this product is covered by the Waste Electrical or Electronic Equipment (WEEE) Directive. It should not be disposed of with other household or commercial waste.

At the end of the product's useful life, the packaging and product should be disposed of via a suitable recycling centre. Please contact your local authority or the retailer from where the product was purchased for information on available facilities.

Declaration of Performance

This equipment complies with the essential requirements of the Radio and Telecommunications Terminal Equipment Directive, 1999/5/EC.

Additional Accessories

This can easily be extended at any time with the range of ERA Wireless Alarm Accessories for details visit www.erahomesecurity.com or call our Customer Support team on 0345 257 2500 (local call rate).

TABLE OF CONTENT

Kit Contents	3
1. Get to know your product	3
1.1 Features	4
2. Installation	5
2.1 Video Handset Battery Installation	5
2.2 Outdoor Camera Battery Installation	6
2.3 Charging the Video Handset	6
2.4 Connecting the Outdoor Camera to a power supply and/or unlock module (optional accessories)	7
3. Settings	9
3.1 Volume (9 Levels)	10
3.2 Brightness (9 Levels)	10
3.3 Key Tone	10
3.4 Ring Tone	11
3.5 Auto Snap Settings	11
3.6 Snap Show	11
3.7 Date & Time	12
3.8 Door Set	12
3.9 Language	13
3.10 Wallpaper (3 Styles)	13
3.11 Register	13
3.12 Software Version	13
3.13 Default Settings	13
4. Setup	14
4.1 Registration	15
4.2 De-registration	15
5. Operation	15
5.1 Outdoor Camera Operation	16
5.2 Unlocking	16
5.3 Monitoring	16
5.4 Tamper Alarm	16
5.5 Backlight	16
6. Specification	17
7. Additional Accessories	17
Notes	18
ERA Product Guarantee	19

KIT CONTENTS

- Video Handset x 1
- Lithium Battery x 1
- Charger Base x 1
- Power Adapter (12V, 500mA) x 1
- Outdoor Camera x 1
- Battery Cover x 1
- Cable Cover x 1
- Bracket x 1

When unpacking your video intercom please check that all parts are present. If you have any queries regarding your purchase please contact our customer support helpline, prior to installation and set-up.

1. GET TO KNOW YOUR PRODUCT

Wireless Video Handset

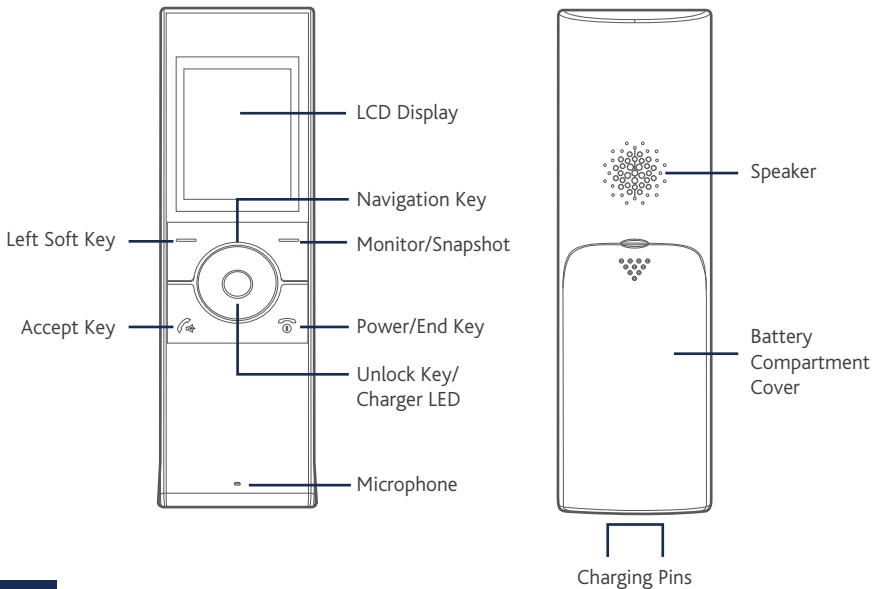

Outdoor Camera

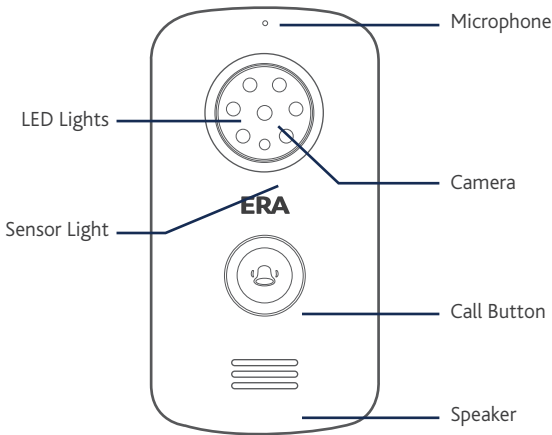

Charge Base

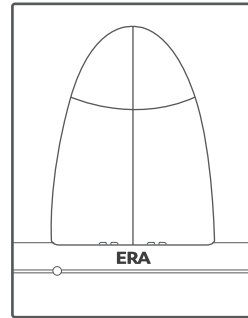

1.1 Features

Up to 500 metres operating range in clear line of sight. Supports up to 2 outdoor cameras and 2 video handsets.

Wireless Outdoor Camera/Intercom/Doorbell

- Battery operated (requires C Cell batteries x 2, not included)
- Power supply option (requires DC 12V Power adapter, not included)
- IP55 rated
- 8 LEDs for night vision
- Video resolution: 320x240, 15 frames per second
- Wide angle lens - 120 viewing angle
- Auto snap feature - stores up to 100 snaps
- Backlit call button (doorbell)
- Talk with the person at the video handset
- Monitoring feature
- Tamper protection

Wireless Indoor Video Handset

- 2.4" TFT LCD display
- Adjustable brightness and talk volume
- See, hear and talk with the visitor at your door
- Monitoring feature

2. INSTALLATION

2.1. Video Handset Battery Installation

Fit the rechargeable lithium battery (3.7V, 1100mA) supplied as follows -

1. Remove the battery compartment cover by pushing down on the raised arrow and sliding the cover in a downward direction.
2. Remove the battery's protective film and insert the battery into the battery compartment, taking care to correctly match the polarity (+, -).
3. Replace the battery cover by sliding it upwards until it snaps into place.

The status of the handset battery is shown in the top right-hand corner of the screen when in standby mode.

Note:

1. Should the battery not reach its full storage capacity after recharging, replace with a new battery.

2. When replacing the battery use only an equivalent lithium battery.

DO NOT use any other battery type.

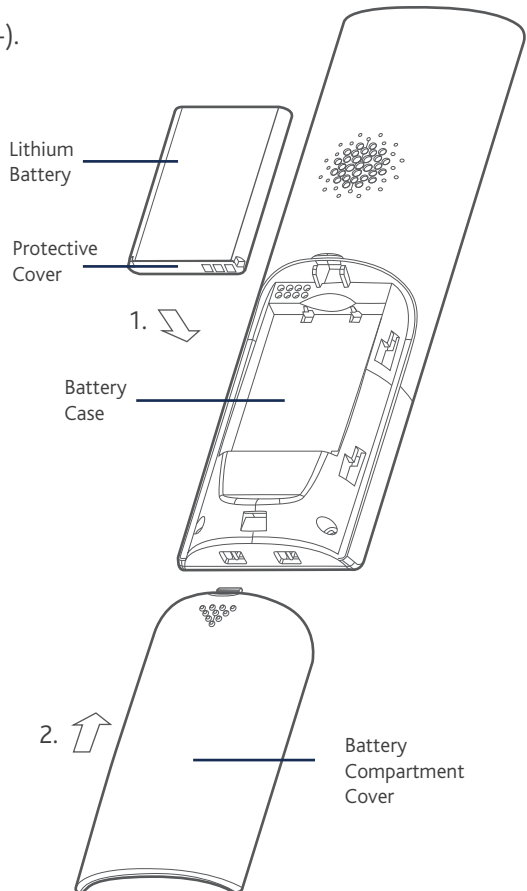

2.2. Outdoor Camera Battery Installation

1. Fit two 'C' size 1.5V batteries (not supplied) into the battery compartment.
2. Fix the battery cover in place using the four screws provided.

The status of the outdoor camera batteries is shown in the top left-hand corner of the screen when in monitoring mode and during a call.

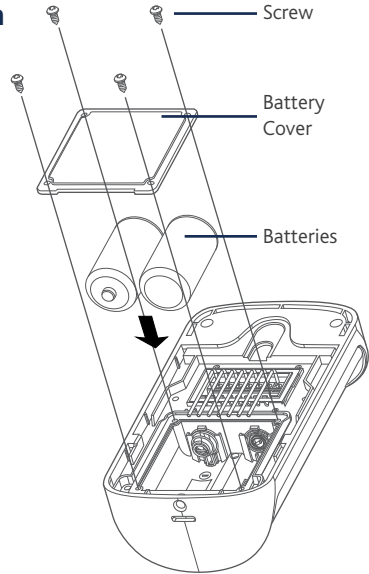

2.3. Charging the Video Handset

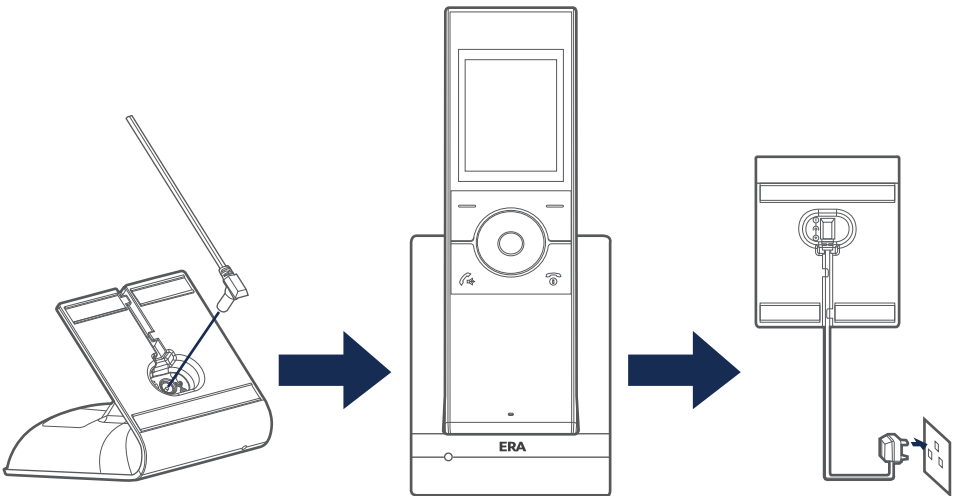

Connect the modular end of the AC power adapter to the power jack of the charger, then plug the AC adapter into a suitable mains socket. Fully charge the handset prior to initial operation (approx. 5 hours).

Note: When the handset is charging, the 'Unlock' button will be illuminated.

2.4. Connecting the Outdoor Camera to a Power Supply and/or Unlock Module (optional accessories)

Connection Mode 1 Normally 'Open'

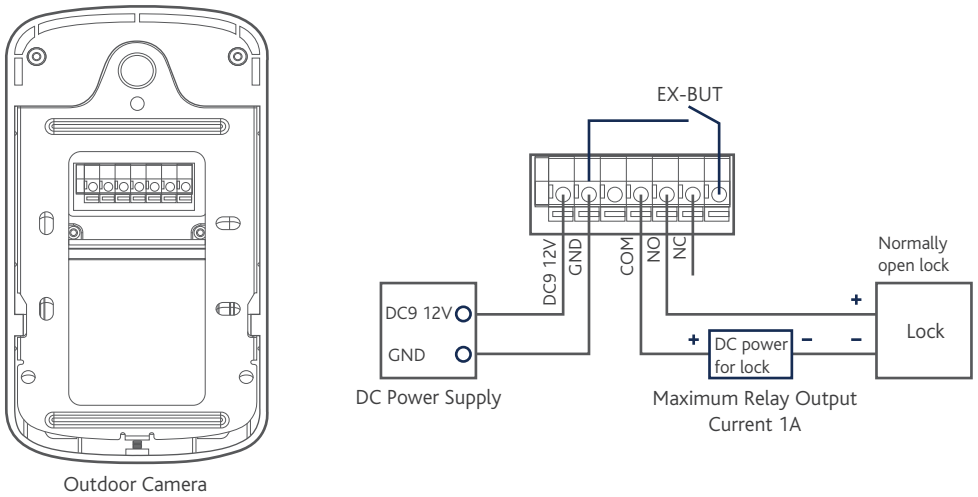

Connection Mode 2 Normally 'Closed'

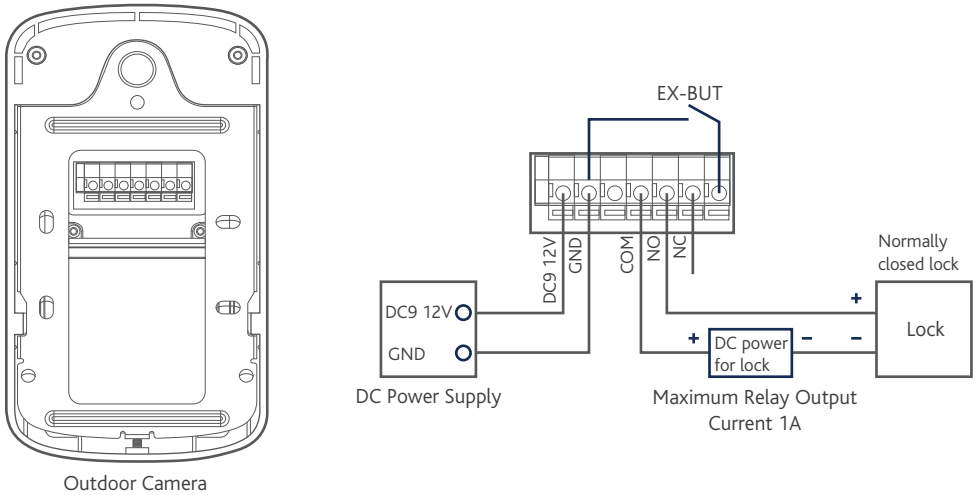

Note: The outdoor camera can be either battery powered or mains powered by compatible AC adapter (not supplied). Do not use both batteries and an AC adapter at the same time. The call button backlight is only available when the outdoor camera is mains powered.

After wiring a power supply and/or unlock module (not included) to the connection terminal, tension the cable. Fit the cable cover over the connection terminal with the four screws supplied.

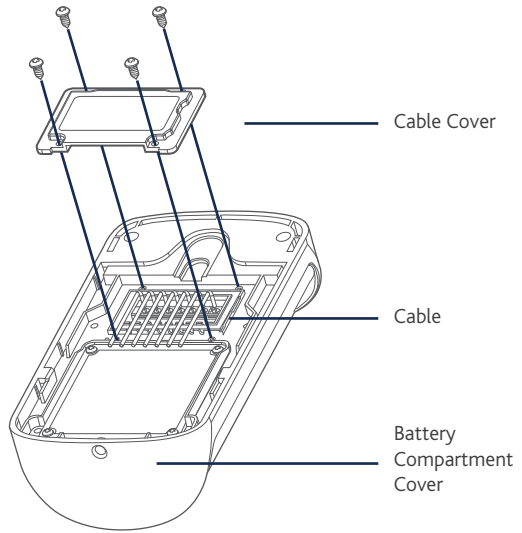

Connection Mode 1 Normally 'Open'

When locating the outdoor camera, position the camera lens at an average 'head height'. Fix the bracket to the wall with the screws supplied and locate the outdoor camera onto the wall bracket. Finally fit the anti-tamper screw.

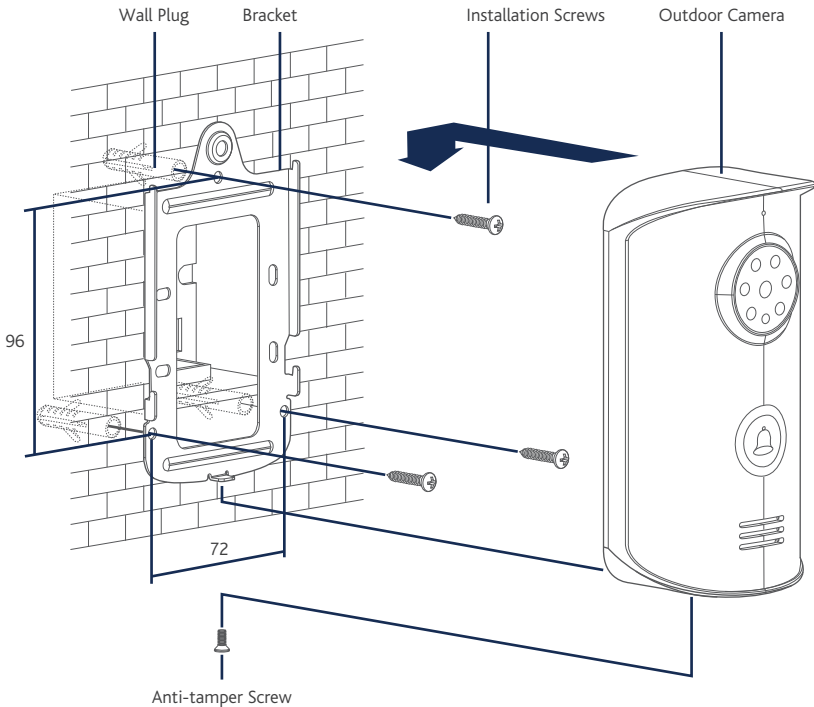

3. SETTINGS

Turning On/Off

To turn on the indoor handset press and hold .



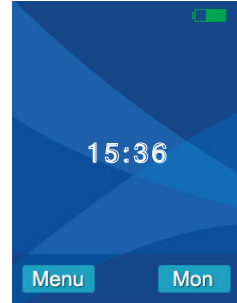

To turn off the indoor hand, press and hold .

When you turn on the video handset, this screen will be displayed.







Note: When the video handset battery is low the low battery icon  will be displayed on the screen and a warning tone will sound. Replace the batteries with an equivalent type.



Setting the Volume & Brightness

To volume and brightness can be set when in standby mode and during a call. From the 'Home' screen press **Right**  or **Left**  to increase/decrease the volume. To increase/decrease the brightness press **Up**  or **Down** .

Setting up a Menu Function from the Video Handset

Press  to select the Menu Screen. To view and edit a menu function scroll down  to select the required function, when highlighted press the Select key. Press **Up** , **Down** , **Left**  or **Right**  to set your chosen option, then press Select to set and return to the main menu. To return to the main menu without making a change to any function press the **Back** button.

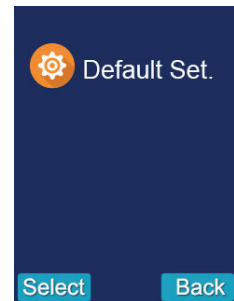
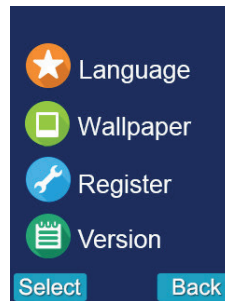
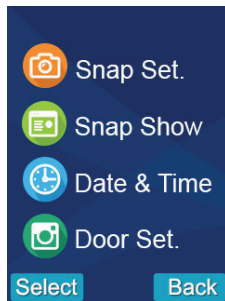
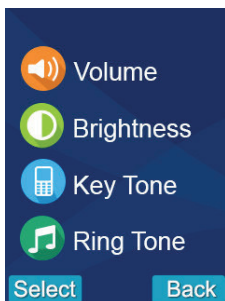

3.1. Volume (9 Levels)

1. Press **Up** ⬆ or **Down** ⬇ to choose 'Volume' menu, then press ⏻ beneath **Select**.
2. Press **Left** ⬅, or **Right** ➡ to select the volume that you like.
3. Press ⏻ beneath **Select** to save the settings and return to the previous menu.

Note: Also, you can use **Left** ⬅ or **Right** ➡ key to adjust the volume in standby mode.

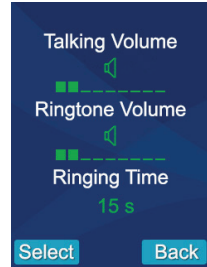

3.2. Brightness (9 Levels)

1. Press **Up** ⬆ or **Down** ⬇ to choose 'Brightness' menu, then press ⏻ beneath **Select**.
2. Press **Left** ⬅, or **Right** ➡ to select the light level that you like.
3. Press ⏻ beneath **Select** to save the settings and return to the previous menu.

Note: Also, you can use **Left** ⬅ or **Right** ➡ key to adjust the brightness in standby mode.

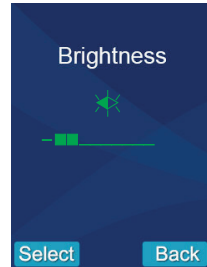

3.3. Key Tone

Each time you press a key a 'key tone' is heard. In certain error conditions, for example when an incorrect key is pressed a warning tone will sound.

1. Press **Up** ⬆ or **Down** ⬇ to choose 'Key Tone' menu, then press ⏻ beneath **Select**.
2. Press **Up** ⬆, or **Down** ⬇ to select **On** or **Off** to enable or disable the function.
3. Press ⏻ beneath **Select** to save the setting and return to the previous menu.

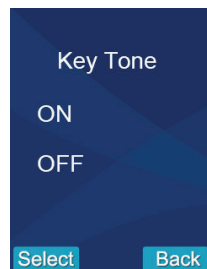

3.4. Ring Tone

1. Press **Up** ⬆ or **Down** ⬇ to choose 'Ring Tone' menu, then press ⊖ beneath **Select**.
2. Press **Left** ⬅, or **Right** ➡ to choose the ring tone. Each time you press Up ⬆ or Down ⬇ the video handset will play the selected ring tone.
3. Press ⊖ beneath **Select** to save the settings and return to the previous menu.



3.5. Auto Snap Settings

1. Press **Up** ⬆ or **Down** ⬇ to select 'Snap Set' menu, then press ⊖ beneath **Select**.
2. Press **Up** ⬆, or **Down** ⬇ to choose On or Off to enable or disable the function
3. Press ⊖ beneath **Select** to save the settings and return to the previous menu.

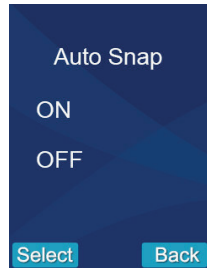

With 'Auto Snap' On, the camera will take a photo of visitor automatically when the outdoor camera's call button is pressed. Photos can be viewed on the video handset in 'Snap Show'.

Note:

1. To take a photo of your visitor during a conversation or when using the 'monitoring' feature, press the 'Snap Key' to save it to the video handset.
2. Up to 100 photos can be stored to the handset. Stored photos are sequentially over-ridden when the number exceeds 100.

3.6. Snap Show

1. Stored photos can be viewed or deleted in the 'Snap Show' menu. The snap number is displayed in the upper right corner of the photo.

1. Press **Up** ⬆ or **Down** ⬇ to select 'Snap Set' menu, then press ⊖ beneath **Select**.
2. Press **Left** ⬅, or **Right** ➡ to view photos.
3. To delete a photo press ⊖. In the centre of the screen '🗑' will be displayed, press '✓' at the bottom left of the screen to confirm deletion or 'x' at the bottom right of the screen to cancel. The next photo will be displayed.
4. Press ⊖ beneath ⬅ to return to the previous menu.



3.7. Date & Time

1. Press **Up** ⬆ or **Down** ⬇ to choose 'Date & Time' menu, then press ⏻ beneath **Select**.
2. Press **Left** ⬅, or **Right** ➡ to choose the hour or the minute and press Up ⬆ or Down ⬇ to adjust
3. To set the date press **Left** ⬅ or **Right** ➡ to select the date, month and year, then press **Up** ⬆ or **Down** ⬇ to adjust.
4. Press ⏻ beneath **Select** to save the settings and return to the previous menu.

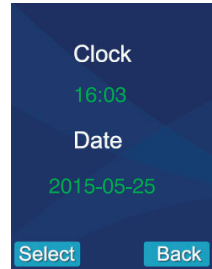

Note:

1. The time format is 24 hour. The date format is YYYY-MM-DD.
2. The Date and Time when the handset is first Hour-Minute-Year-Month-Date.
3. Set the date and time when the handset is first changed to ensure that the time recorded to the photos are correct.
4. When the battery is changed the time and date will need to be set again.

3.8. Door Set

1. Press **Up** ⬆ or **Down** ⬇ to choose 'Door Set' menu, then press ⏻ beneath **Select**.
2. To toggle between the three functions (Volume, Ring Time, Unlock Time) press **Up** ⬆ or **Down** ⬇. Each setting can be changed as follows:
 - Volume (9 levels): press **Left** ⬅ or **Right** ➡ to select
 - Ring Time (between 1 and 15 seconds) press **Left** ⬅ or **Right** ➡ to select
 - Unlock Time (between 1 and 9 seconds): if an optional 'Unlock Module' is fitted, the unlock duration of the associated locking mechanism can be set by pressing **Left** ⬅ or **Right** ➡.
3. To save each setting individually press ⏻ beneath **Select** with each change as it is made, at each stage you will return to the menu screen from where you return to the menu change remaining settings. To change all settings without returning to the previous menu, make the changes then press **Select** to accept all changes.

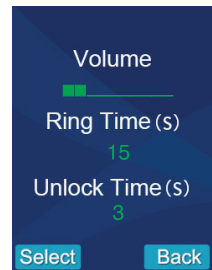

Note: When there are two video handsets connected to one outdoor camera, the setting of the two handsets must be the same.

3.9. Language

1. Press **Up** ⬆ or **Down** ⬇ to choose 'Language' menu, then press ⏪ beneath **Select**.
2. Press **Up** ⬆, or **Down** ⬇ to choose the corresponding language ('0' for English)
3. Press ⏪ beneath **Select** to save the settings and return to the previous menu.

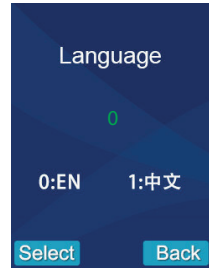

3.10. Wallpaper (3 styles)

1. Press **Up** ⬆ or **Down** ⬇ to select a wallpaper and ⏪ to confirm. Press **Back** to exit the screen without making any changes to the current wallpaper.



3.11. Register

Used to link the outdoor camera to a video handset, as described on page 14.

3.12. Software Version

To check the software version press **Up** ⬆ or **Down** ⬇ to select the 'Version' menu, then press ⏪ to select. Press **Back** to return to the previous menu.

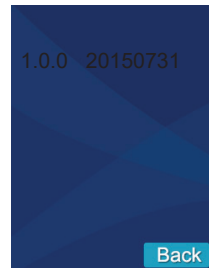

3.13. Default Settings

This function allows you to reset the video handset to factory settings.

1. press **Up** ⬆ or **Down** ⬇ to select the 'Default Set' menu, then press ⏪ beneath **Select**.
2. Press **Up** ⬆ or **Down** ⬇ to choose **YES** or **NO** to enable or disable the function.
3. Press ⏪ beneath **Select** to reset the settings or **Back** to return to the previous menu.

After resetting, the video handset will return to standby mode.

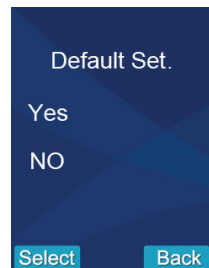

4. SETUP

4.1. Register

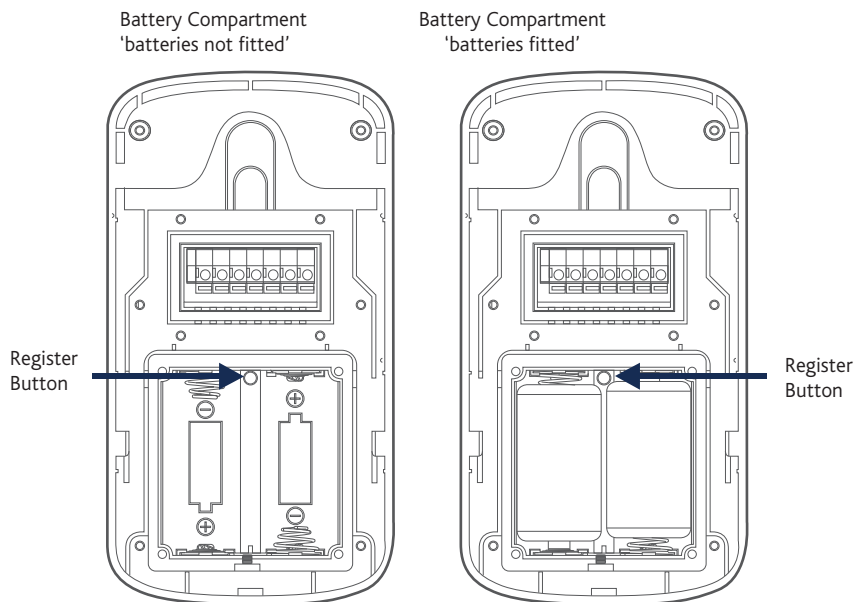

1. Insert a small screwdriver or similar item into the depression just above the '📶' symbol inside the outdoor camera battery compartment and depress the register button with the screwdriver for 3 seconds. The unit will sound an indication tone and the call button backlight will illuminate.
2. Press **Menu** beneath **Menu** on the video handset, then select the register menu, press **Up** ▲ or **Down** ▼ to choose the door camera that you want to connect (1-2 are selectable), then press **Enter** ▼ beneath **✓** to confirm the setting. The outdoor camera will automatically search for the video handset to be registered. When the video handset sounds an indication tone, the outdoor camera and video handset are registered successfully.



3. Press **Enter** ▼ beneath **Menu**, then select 'Register' menu. The system will enter into the register interface indicating that the outdoor camera is successfully registered to the video handset.

Note: If you reset the video handset to the factory default, all settings will revert to factory settings.

4.2. De-registering

1. To delete the registration press ⊖ beneath . The display will show '❌', press ⊖ beneath '√' to confirm or 'x' to cancel. Press ⊖ beneath  to return to the main interface.

Note:

1. Outdoor camera registration can take up to 60 seconds.
2. Video handset registration can take up to 20 seconds.
3. Up to 2 outdoor cameras and 2 video handsets can be supported.

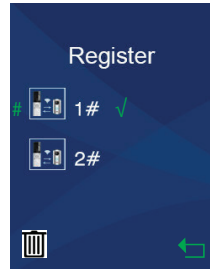

4.3. De-registering



1. The video handset is set to **'power saving mode'** in order to obtain maximum battery life from the outdoor camera when battery powered. When in power saving mode the monitoring feature is not available.

2. To enable the monitoring feature when the outdoor station is powered by batteries (not mains powered), press the **'register'** button for 3 seconds, the outdoor camera will enter into **'register'** status, press the **'register'** button again for 3 seconds, 3 **'bleeps'** will be heard. The outdoor camera will switch from **'power saving mode'**, under **'registered'** status press the **'register'** button for 3 seconds, the outdoor camera will sound one long tone and revert to **'power saving mode'**, the monitoring feature will no longer be available.

5. OPERATION

5.1. Outdoor Camera Operation

When the outdoor camera call button is pressed the corresponding video handset will ring and an image of the visitor will appear on the video handset screen. If the call button is pressed again the conversation will end.

1. To reject the call press  to cancel the ringer and the video.
2. To enable the two-way conversation, press  on the video handset (the ring tone will stop). To end the conversation press  on the video handset or the call button on the outdoor camera.

Note:





1. Ring time lasts up to 15 seconds
2. Conversation time will last up to 45 second, the call will automatically disconnect.

5.2. Unlocking

To utilise the 'unlock' feature an unlock module (available separately) and the unlock mechanism are required. When fitted, during a conversation or 'monitor' status, the door can be unlocked for a set period of time by pressing the  button on the video handset (**Note: this will end the call**).



5.3. Monitoring

This feature will allow you to view the picture from the outdoor camera on demand.

1. In standby mode, press  beneath 'Mon'.
2. If only one outdoor camera is registered the LCD screen will automatically display the picture from that outdoor camera.
3. If two outdoor cameras are registered the LCD screen will display **1#** and **2#**
Monitor. Press **Up**  or **Down**  to select the camera you wish to monitor, the press  beneath **Select**.
4. In monitoring mode, press **Accept**  to enter into intercom communication.

Note: *The maximum monitoring time is 45 seconds.*

5.4. Tamper Alarm

When the outdoor camera is moved from its bracket, both the outdoor camera and video handset will sound an alarm tone. To outdoor camera call button will be inoperable, press  or  to stop the alarm tones.

Note: *The alarm will sound for up to 5 minutes*

5.5. Backlight

1. When the outdoor camera power supplied by DC 12V, the call button backlight will be illuminated. During registration, calling, alarm, monitoring and intercom status, the backlight will flash.
2. When the outdoor camera power is supplied by batteries and is in 'power consumption' mode, the call button will flash during activation (registration, calling, alarm, monitoring and intercom status). The call button will not be backlit.
3. When the outdoor camera is powered by batteries and in "power save" mode, the call button will flash only during activation (when the call button is pushed) and then will stop.

6. SPECIFICATION

Outdoor Camera

Transmit Frequency Range	2.4GHz - 2.4835GHz
Data Rate	2.0Mbps
Transmitting Power	19dBm (TYP)
Modulation Type	GFSK
Transmitting Distance	Outdoor: ≥260m
Image Sensor Type	Colour CMOS Image Sensor
Image Processing	H.264
Camera Pixels	640x480
White Balance	Auto
Viewing Angle (Diagonal)	120°
LED	6 LEDs
Power Requirement	+9V-12V)±5%/2*LR14(C),1.5V batteries
Power Consumption	500mA Max (Cells) 200mA Max (+12V DC)
Operating Temperature	Temperature -20°C ~ +55°C - Humidity 20% - 90% (Non-condensing)
Dimensions	80mm x 160mm x 55mm
No. of indoor Handsets Supported	Max.2

Video Handset

Receiving Frequency Range	2.4GHz - 2.4835GHz
Monitor	2.4 Colour LCD
Data Rate	2Mbps
Receiving sensitivity	85Bm
Demodulation Type	GFSK
LCD Resolution	320x240 (RGB)
Transmitting Power	19dBm (TYP)
Power Requirement	BL-5C, 3.7V, 1100mA (lithium battery)
Power Consumption	400mA Max
Operating Temperature	Temperature -10°C ~ +55°C Humidity 20% - 90% (Non-condensing)
Indoor Monitor Dimensions	52.7mm x 188.2mm x 26.3mm
Charger Base Dimensions	80mm x 95.2mm x 103.7mm
No. of Door Cameras Supported	Max.2

7. ADDITIONAL ACCESSORIES

Additional accessories are available for the E3000 Video Door Intercom system including:

- | | |
|----------------------------------|----------|
| • Additional handset and charger | E3000HSC |
| • Additional outdoor station | E3000-OS |
| • Outdoor station rain cover | CLOSRC |
| • Outdoor station power supply | CLOSPSU |
| • Unlock module | CL3660UM |

ERA PRODUCT GUARANTEE

We at ERA firmly believe in the quality of our goods. Our technology achieves outstanding performance and durability and we can therefore offer, in addition to your statutory rights, an additional limited guarantee. In the event of any material defects in any product manufactured by us due to faulty design, materials and/or workmanship, and which arise following correct installation and during normal use in accordance with our instructions, as included in the product packaging, within the period of two years from the date of purchase, we will either repair, provide a replacement, substitute with an equivalent product free of charge from our then current range or refund in full the amount paid for the product at point of purchase.

Conditions

In order to take advantage of our guarantee, you must comply with the following conditions:-

1. This limited guarantee is not transferable and is extended only to, and is solely or the benefit of, the original purchaser of the product. Please retain your dated sales invoice as proof of purchase and forward this to us if you wish to make a claim under this guarantee.
2. Products must be installed, used and maintained in accordance with our instructions otherwise the guarantee will be invalidated.
3. The product must not be damaged or modified in any way nor must it have been subjected to any unauthorised repairs.

Exclusions

This guarantee does not cover:-

1. Periodic maintenance, repair and replacement of parts due to fair wear and tear.
2. Abuse or misuse, including but not solely limited to the failure to use this product for its normal purposes or in accordance with ERA's instructions on usage and maintenance.
3. Failure of the product arising from incorrect installation or use not consistent with the instructions supplied and the cost of any removal or installation of products.
4. Accidents, Acts of God, lightning, water, fire, public disturbances, improper ventilation, voltage fluctuations or any cause beyond the control of ERA (Force Majeure).
5. Unauthorised modifications carried out to the product.
6. Damage caused by incorrect/improper use of supplied batteries.
7. Alteration to, deletion, removal or illegibility of the Serial Number as shown on the Product Label.
8. Consumables: any damages so caused by the use of batteries not supplied by ERA.
9. Repair or attempted repairing by bodies who are not ERA authorised repairers.
10. Neglect.
11. The loss of any stored data on your product.

This guarantee is in addition to your contractual and statutory rights and does not affect your statutory rights.

To make a claim

Please contact Customer Support either by telephone on 0345 257 2500 or email support@erahomesecurity.com, with full details of your claim. If your claim satisfies our Conditions and is not subject to any of our Exclusions, we will agree with you the repair, replacement, substitution or refund of payment of goods. For product returns you will be issued with a Return Authorisation Number (RAN). Please note: Returns will not be accepted unless accompanied by a RAN.

*Terms and conditions apply.

ERA



**Customer Helpline:
0345 257 2500**

www.erahomesecurity.com

ERA Home Security Ltd
Valiant Way, Wolverhampton,
West Midlands, WV9 5GB
email: support@erahomesecurity.com